

GLYNN-JOHNSON®

Push/pull
latches



Quality hardware for superior door control

Known throughout the industry as the “overhead door holder specialist,” Glynn-Johnson has made its name with state-of-the-art manufacturing and technology. The portfolio also includes a full line of push/pull latches that are ideal for healthcare applications. Delivering both superior quality and exceptional performance, Glynn-Johnson products are offered in a wide variety of popular finishes and configurations providing the flexibility needed to meet the most demanding door control applications.

To learn more visit www.allegion.com/us or call us at 877-671-7011.



Index

Standard function - HL6	4-5
Privacy function - PL7 or PL8	6-7
Mortise lock function - HL6	8-10
Engraving guide	11

Finishes

Finish no.	Description
US3	Polished brass
US4	Satin brass
US10	Satin bronze
US10B	Oil rubbed bronze
US26	Polished chrome
US26D	Satin chrome
US32D	Satin stainless steel

Push/pull latch

Glynn-Johnson HL6

Glynn-Johnson offers a complete line of door hardware, providing solutions for the most complex door control problems. The HL6 push/pull latch offers versatility and durability for commercial and institutional settings. These models are designed for commercial and institutional doors up to 1 ³/₄" , including single fire doors. For doors over 1 ³/₄" please specify door thickness.

Six mounting positions:

- Increases versatility
- Suits a wide range of applications
- Mounts in any of six positions
 - Handles down
 - Handles up
 - One handle up, one handle down (either push or pull)
 - Handles point away from latch
 - Handles point toward latch

Four backset sizes:

- 2 ³/₄"
- 3 ³/₄"
- 5"
- 7"

Two strike sizes:

- Standard – 2 ³/₄"
- ASA – 4 ⁷/₈"

Seven options:

- B—brass base material for US26D finish
- E—Engraved handles – “push” and “pull”
- EN—Entrance only latch
- EO—Exit only latch
- L—Lead lined
- RL—Roller latch conversion kit
- SOC—Pin-in-socket security screws

Finishes:

- US3, US4, US10, US10B, US26, US26D, US32D
 - Optional: RAL powder coat finishes available. Consult factory

Unmatched convenience:

- Non-handed
- Variable mounting positions
- No fusible link to fail
- UL listed for all single labeled metal or wood doors

Application information

The sleek design has a short throw angle, allowing the door to be opened with an easy push or pull action, even when hands are not free.

For applications with the handles pointing towards the latch edge of the door, the 7" backset must be used. All other handle orientations may use any backset.

Options

Suffix B (brass base-material)

The option of using brass handles and covers instead of the standard zinc for the US26D finish.

Suffix E (engraved handles)

Adds engraving to the handles “push” and “pull”. See page 11 for engraving guide. Engraved handles are not recommended for humid applications.

Suffix EN (entrance only)

The entrance only latch is appropriate for doors where only one side is used for entry, pull handle only. Order HL6EN for applications where no exit is required.

Suffix EO (exit only)

The exit only latch is appropriate for doors where only one side is used for exit, push handle only is required. Order HL6EO for applications where the security of no entry.

Suffix L (lead lining)

The lead lining kit provides lead components to cover cut-outs made in lead lined doors.

Suffix RL (roller latch conversion)

The push/pull roller latch conversion kit is used to convert existing Glynn-Johnson 30 roller latches to meet current federal standard requirements. Minimal alterations are required, to the door edge. Kit includes the faceplate adapter making the latchbolt faceplate 1 ¹/₈" x 3 ³/₈". The kit also includes a full lip strike which is 2 ¹/₄" tall.

Suffix SOC (pin-in-socket security screws)

The option of having pin-in-socket security screws instead of standard screws. Pin-in-socket screws are provided for the strike, latch bolt and covers.

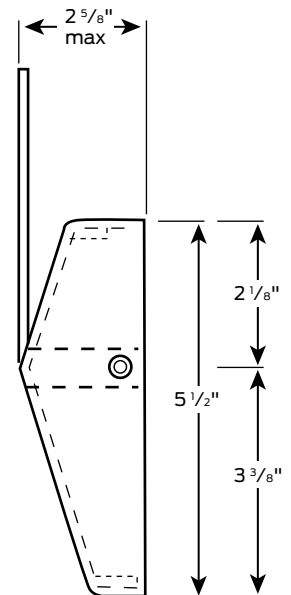
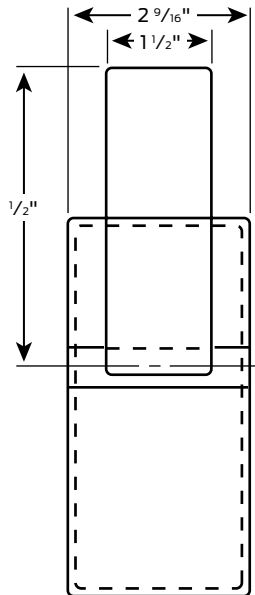

How to order

HL6

Options:

B	Brass base material on US26D
E	(1, 2, 3, 4, 5, or 6) - engraved handles
EN	Entrance only
EO	Exit only
L	Lead lined
RL	Roller latch conversion kit
SOC	Pin-in-socket security screws

Finishes:

US3	Polished brass
US4	Satin brass
US10	Satin bronze
US10B	Oil rubbed bronze
US26	Polished chrome
US26D	Satin chrome
US32D	Satin stainless steel

Backset:

2	2 3/4"
3	3 3/4"
5	5"
7	7"

Strike:

Blank	Standard strike
A	ASA strike

Door thickness:

Blank	1 3/4" door, specify other thickness
--------------	--------------------------------------

Privacy function push/pull latch

Glynn-Johnson PL7 / PL8

Glynn Johnson offers a wide range of door hardware to provide solutions for the most complex door control problems. The PL7 and PL8 privacy function push/pull latches provide the versatility and durability needed for commercial and institutional doors up to 1 3/4", including single fire doors.

Two models:

- PL7 for push-side thumbturn
- PL8 for pull-side thumbturn

Three mounting positions:

- Increased versatility
- Mount in any of three positions
 - Handles down
 - Handles up
 - Handles point towards latch

Four sizes of backsets:

- 2 3/4"
- 3 3/4"
- 5"
- 7"

Two strike sizes:

- Standard—2 3/4"
- ASA—4 7/8"

Five options:

- B—Brass base material for US26D finish
- E—Engraved handles – “push” and “pull”
- L—Lead lined
- RL—Roller latch conversion kit
- SOC—Pin-in-socket security screws

Finishes:

- US3, US4, US10, US10B, US26, US26D, US32D
 - Optional: RAL powder coat finishes available. Consult factory

Unmatched convenience:

- Non-handed
- Variable mounting positions
- No fusible link to fail
- UL listed for all single labeled metal or wood doors

Application information

The patented design is ideal for restrooms or patient bathrooms. It combines all the features and functions of the popular HL6 push/pull latch, with the added convenience of privacy actuated by a thumbturn.

The sleek design has a short throw angle, allowing the door to be opened with an easy push or pull action, even when hands are not free. The release on opposite side provides for access in case of emergency.

For applications with the handles pointing towards the latch edge of the door, the 7" backset must be used. Both handles must point in the same direction. When both handles point up or down, any backset may be used.

Options

Suffix B (brass base-material)

The option of using brass handles and covers instead of the standard zinc for the US26D finish.

Suffix E (engraved handles)

Adds engraving to the handles “push” and “pull”. See page 11 for engraving guide. Engraved handles are not recommended for humid applications.

Suffix L (lead lining)

The lead lining kit provides lead components to cover cut-outs made in lead lined doors.

Suffix RL (roller latch conversion)

The Push/pull roller latch conversion kit is used to convert existing Glynn-Johnson 30 roller latches to meet current federal standard requirements. Minimal alterations are required, to the door edge. Kit includes the faceplate adapter making the latchbolt faceplate 1 1/8" x 3 3/8". The kit also includes a full lip strike which is 2 1/4" tall.

Suffix SOC (pin-in-socket security screws)

The option of having pin-in-socket security screws instead of standard screws. Pin-in-socket screws are provided for the strike, latch bolt and covers.

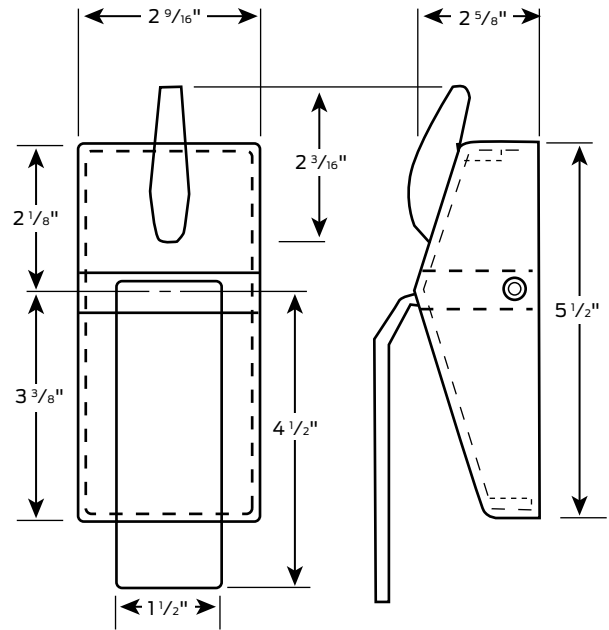

How to order

PL

Model:

- 7** Push-side thumbturn
- 8** Pull-side thumbturn

Options:

- B** Brass base material on US26D
- E** (2, 3, 4, or 6) - engraved handles
- L** Lead lined
- RL** Roller latch conversion kit
- SOC** Pin-in-socket security screws

Finishes:

- US3** Polished brass
- US4** Satin brass
- US10** Satin bronze
- US10B** Oil rubbed bronze
- US26** Polished chrome
- US26D** Satin chrome
- US26D-AM** Satin chrome - antimicrobial
- US32D** Satin stainless steel
- US32D-AM** Satin stainless steel - antimicrobial

Backset:

- 2** 2 3/4"
- 3** 3 3/4"
- 5** 5"
- 7** 7"

Strike:

- Blank** Standard strike
- A** ASA strike
- BT** Bent tab strike

Door thickness:

- Blank** 1 3/4" door, specify other thickness

Combination push/pull latch and mortise lock

Mortise lock option

The HL6 push/pull latch is available with a Schlage® L Series heavy-duty mortise lock included. Mortise lock combination models are furnished in 2 3/4" backset.

Five mounting positions:

- Increased versatility
- Mount in five positions
 - Handles down
 - Handles up
 - One handle up, one handle down (either push or pull)
 - Handles point away from latch
- Suits a wide range of applications

Cylinder operation:

Where cylinders are required, Glynn-Johnson will supply locks less cylinders. An 1 1/8" cylinder with a cloverleaf cam is required. Handle on cylinder side must be mounted in down position, if vertical mounting is used.

Thumbturn operation:

Where thumbturn operations are required, the handle must be mounted in horizontal position. Standard thumbturn is provided.

Mortise lock retrofit kit:

Kits are available to retrofit existing installations and they include all necessary components. 9000RK is specified for the lock function. If Schlage mortise locks are already installed, the set can be easily converted to push/pull operation with minor modifications to door.*

Mortise lock functions available

For a list of standard lock functions available see page 10. For other lock functions, consult factory.

Six options:

- B—Brass base material for US26D finish
- E—Engraved handles – “push” and “pull”
- EN—Entrance only latch
- EO—Exit only latch
- L—Lead lined
- SOC—Pin-in-socket security screws

Finishes:

- US3, US4, US10, US10B, US26, US26D, US32D
 - Optional: RAL powder coat finishes available. Consult factory

Unmatched convenience:

- Non-handed
- Variable mounting positions
- UL listed for all labeled metal or wood doors

Application information

The unit combines the features and convenience of the HL6 push/pull operation with the durability of the heavy-duty mortise lock. The sleek design has a short throw angle, allowing the door to be opened with an easy push or pull action, even when hands are not free. The mortise lock offers many lock functions, see page 10 and 11 for the specific functions available. The only handle orientation not available would be handles pointing towards the latch edge of the door.

Options

Suffix B (brass base-material)

The option of using brass handles and covers instead of the standard zinc for the US26D finish.

Suffix E (engraved handles)

Adds engraving to the handles “push” and “pull”. See page 11 for engraving guide. Engraved handles are not recommended for humid applications.

Suffix EN (entrance only)

This entrance only latch is appropriate for doors where only one side is used for entry, pull handle only. Order HL6EN for applications where no exit is required.

Suffix EO (exit only)

This exit only latch is appropriate for doors where only one side is used for exit, push handle only. Order HL6EO for applications where the security of no entry is required.

Suffix L (lead lining)

The lead lining kit provides lead components to cover cut-outs made in lead lined doors.

Suffix SOC (Pin-in-socket security screws)

The option of having pin-in-socket security screws instead of standard screws. Pin-in-socket screws are provided for the strike, latch bolt and covers.

* For Schlage models 9082EL Mortise and 9082EU Mortise, contact customer service for pricing availability.



How to order

HL6

Options:

B	Brass base material on US26D
E	(1, 2, 3, 4, 5, or 6) - engraved handles
EN	Entrance only
EO	Exit only
L	Lead lined
SOC	Pin-in-socket security screws

Lock function:

See page 10
9000RK Retrofit kit

Finishes:

US3	Polished brass
US4	Satin brass
US10	Satin bronze
US10B	Oil rubbed bronze
US26D	Satin chrome
US26D-AM	Satin chrome - antimicrobial
US32D	Satin stainless steel
US32D-AM	Satin stainless steel - antimicrobial

Door thickness:

Blank 1 3/4" door, specify other thickness

Mortise lock functions available

Standard lock functions

Lock Number – ANSI Functions – Description

9010 – F01 – Passage latch

Latchbolt retracted by handle from either side at all times.

9040 – F22 – Bath/bedroom privacy lock

Latchbolt retracted by handle from either side unless outside is locked by inside thumbturn. Activating inside handle or closing door unlocks outside handle. To unlock from outside, remove emergency button, insert emergency turn in access hole and rotate.

9050 – F04 – Office/inner entry lock

Latchbolt retracted by handle from either side unless outside is made inoperative by key outside or by turning inside thumbturn. When outside is locked, latchbolt is retracted by key outside or by handle inside. Outside handle remains locked until thumbturn is turned to the unlocked position or outside key is unlocked. Auxiliary latch deadlocks latchbolt when door is closed.

9060 – F09 – Apartment lock

Latchbolt retracted by handle from either side unless outside is locked by key from inside. When locked, latchbolt retracted by key outside or handle inside. Auxiliary latch deadlocks when door is closed.

9070 – F05 – Classroom lock

Latchbolt retracted by handle from either side unless outside is locked by key. Unlocked from outside by key. Inside handle always free for immediate exit. Auxiliary latch deadlocks latchbolt when door is closed.

9080 – F07 – Storeroom lock

Latchbolt retracted by key outside or by handle inside. Outside handle always inoperative. Auxiliary latch deadlocks latchbolt when door is closed.

9080EL – Electrically locked (fail safe)

Outside handle continuously locked by 24V AC or DC. Latch bolt retracted by key outside or handle inside. Switch or power failure allows outside handle to retract latchbolt. Auxiliary latch deadlocks latchbolt when door is closed. Inside handle always free for immediate exit.

9080EU – Electrically unlocked (fail secure)

Outside handle unlocked by 24V AC or DC. Latchbolt retracted by key outside or handle inside. Auxiliary latch deadlocks latchbolt when door is closed. Inside handle always free for immediate exit.

9082 – Institution lock

Latchbolt retracted by key from either side. Handle on both sides always inoperative. Auxiliary latch deadlocks latchbolt when door is closed.

9082EL w/XL11-452 – Electrically locked (fail safe)

Outside and inside handle continually locked with 24V AC or DC. Latchbolt retracted by key either side. Switch or power failure allows outside and inside handle to retract latchbolt. Auxiliary latch deadlocks latchbolt when door is closed.*

9082EU w/XL11-452 – Electrically unlocked (fail safe)

Outside and inside handle unlocked with 24V AC or DC. Latchbolt retracted by key either side. Auxiliary latch deadlocks latchbolt when door is closed.*

9453 – F20 – Entrance lock

Latchbolt retracted by handle from either side unless outside is locked by 20 rotation of thumbturn. When locked, key outside or handle inside retracts deadbolt and latchbolt simultaneously. Outside handle remains locked until thumbturn is restored to vertical position. Throwing deadbolt automatically locks outside handle. Auxiliary latch deadlocks latchbolt when door is closed.

9456 – F13 – Corridor lock

Latchbolt retracted by handle from either side. Deadbolt thrown or retracted by key outside or inside thumbturn. Throwing deadbolt locks outside handle. Activating inside handle simultaneously retracts deadbolt and latchbolt, and unlocks outside handle.

9465 – Closet/storeroom lock

Latchbolt retracted by handle from either side. Deadbolt extended or retracted by key outside.

9466 – F14 – Store/utility room lock

Latchbolt retracted by handle from either side. Deadbolt thrown or retracted by key from either side.

9473 – F21 – Dormitory/bedroom lock

Latchbolt retracted by handle from either side. Deadbolt thrown or retracted by key outside or thumbturn inside.





9485 – Hotel lock

Latchbolt retracted by key outside or by handle inside. Outside handle always fixed. Deadbolt thrown or retracted by inside thumbturn. When deadbolt is thrown, all keys become inoperative except emergency or display keys. Activating handle retracts both deadbolt and latchbolt simultaneously. Auxiliary latch deadlocks latchbolt when door is closed.

* For Schlage models 9082EL mortise and 9082EU mortise, contact customer care for pricing availability.

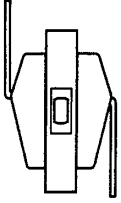
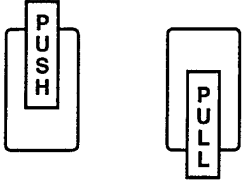
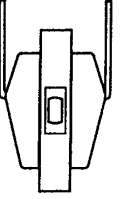
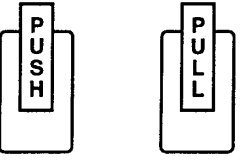
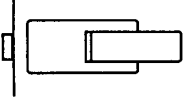
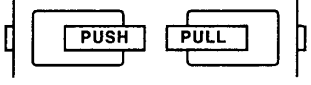
Push/pull latches

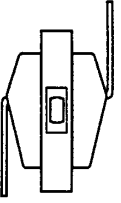
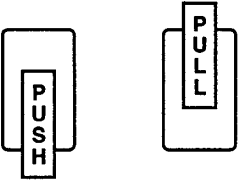
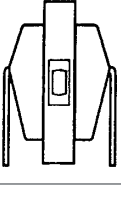
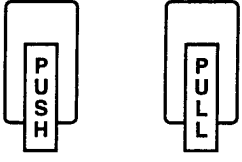
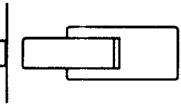
Engraving guide

		Mounting position	To order, specify
		Push up, pull down <ul style="list-style-type: none"> Any backset Non-handed No PL7 or PL8 	E1
		Push up, pull up <ul style="list-style-type: none"> Any backset Non-handed 	E2
		Horizontal engraving <ul style="list-style-type: none"> Any backset RH No PL7 or PL8 	E3
		Horizontal engraving <ul style="list-style-type: none"> Any backset LH No PL7 or PL8 	E4
		Push down, pull up <ul style="list-style-type: none"> Any backset Non-handed No PL7 or PL8 	E5
		Push down, pull down <ul style="list-style-type: none"> Any backset Non-handed 	E6
		Horizontal engraving <ul style="list-style-type: none"> 7" backset only RH No mortise lock 	E4
		Horizontal engraving <ul style="list-style-type: none"> 7" backset only LH No mortise lock 	E3

About Allegion

Allegion (NYSE: ALLE) creates peace of mind by pioneering safety and security. As a \$2 billion provider of security solutions for homes and businesses, Allegion employs more than 8,000 people and sells products in more than 120 countries across the world. Allegion comprises 27 global brands, including strategic brands CISA®, Interflex®, LCN®, Schlage® and Von Duprin®.

For more, visit www.allegion.com

aptiQ ■ LCN ■ **SCHLAGE** ■ STEELCRAFT ■ VON DUPRIN