



**These instructions cover the following models:
90H (Hold Open), 90S (Stop only), 90F (Friction), and 90SE (Special Stop Only)**

⚠ INSTALLATION NOTES

1. Hollow metal frames should be properly reinforced with a 3/16" (5mm) minimum thickness by 12" (305mm) minimum length plate.
2. Hollow metal doors should be properly reinforced with a 3/16" (5mm) minimum thickness by 2-1/2" (64mm) minimum width plate.
3. Stop only units are permitted on many fire door applications. However, mechanical hold-open devices that require manual release are not permitted for use on any fire door as outlined on NFPA80® or NFPA101®. Contact Glynn Johnson or your local representative for assistance.

ADJUSTMENTS

Hold-open tension adjustment (Hold-open model only): Using a phillips screwdriver, turn screw shown clockwise to increase hold-open tension and counterclockwise to decrease hold open tension.

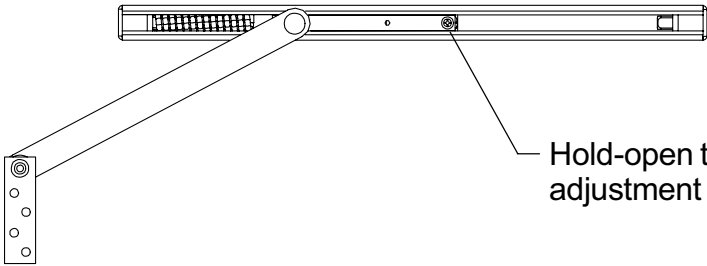

Hold-open tension adjustment screw

Friction adjustment (Friction model only): Using a 3/32" hex wrench, turn screw shown clockwise to increase friction and counterclockwise to decrease friction.

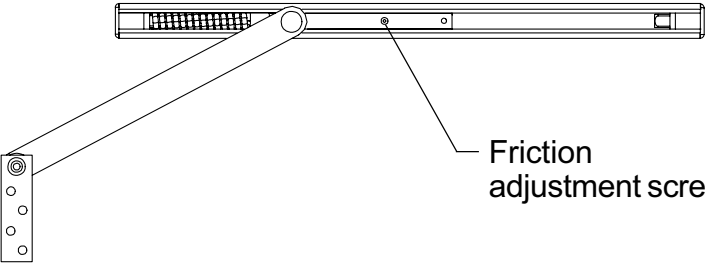

Friction adjustment screw



INST.90

INSTALLATION STEPS

1 Determine what type of hinge or pivot is being used on the door as shown below.

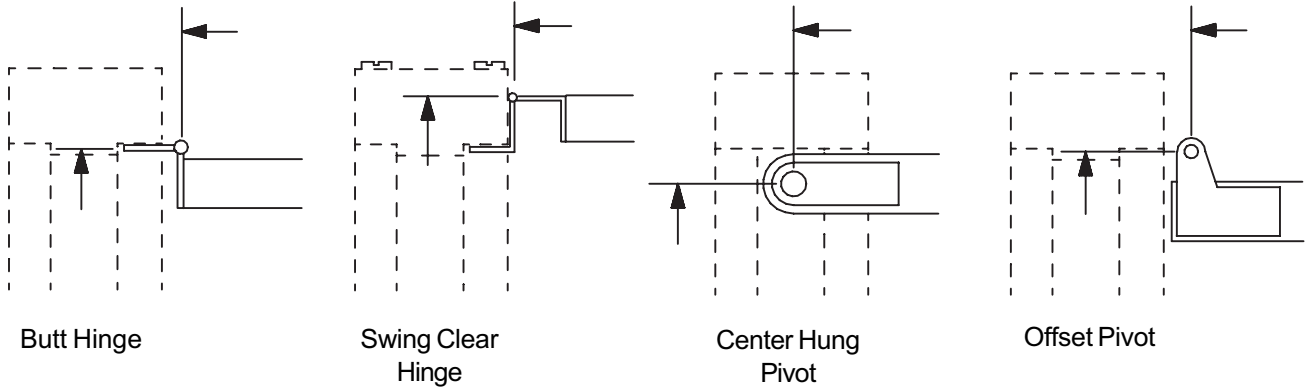

2 Find correct type and size of hinge or pivot on the chart below to identify correct mounting group.

3 Dimensions A, B, and C (shown below) will be used to locate holder on door and frame.

Hinge Type & Size	Mounting Group
Butt Hinge 4" Wide	3
Butt Hinge 4-1/2" Wide	2
Butt Hinge 5" Wide	1
Swing Clear Hinge 4" Wide	1
Swing Clear Hinge 4-1/2" Wide (1-3/4" door)	3
Swing Clear Hinge 4-1/2" Wide (2" door)	2
Swing Clear Hinge 4-1/2" Wide (2-1/4" door)	1
Swing Clear Hinge 5" Wide (1-3/4" door)	3
Swing Clear Hinge 5" Wide (2" door)	2
Swing Clear Hinge 5" Wide (2-1/4" door)	1
Center Hung Pivot (1-3/4" - 2-1/4" doors)	4
3/4" Offset Pivot (1-3/8" door)	3
3/4" Offset Pivot (1-3/4" door)	2
3/4" Offset Pivot (2" or 2-1/4" door)	1
SOSS 220 (2" or 2-1/4" door)	2

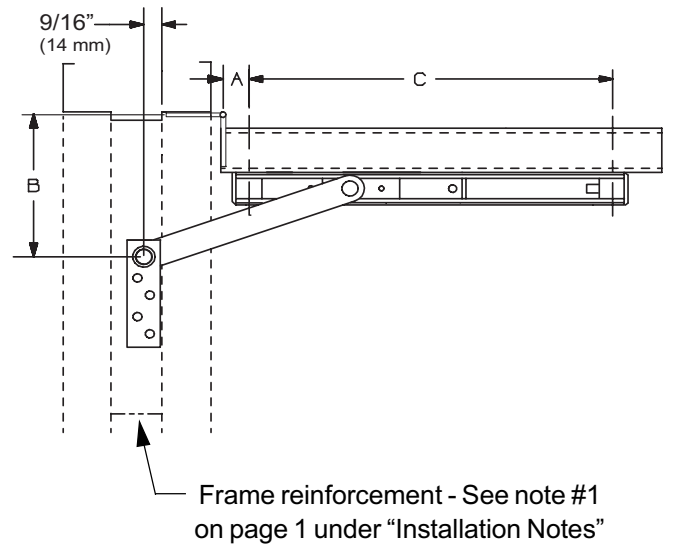

4 Using the mounting group and GJ model numbers, find dimensions "A", "B", and "C" on page 3 chart.

Notes on using chart:

- "Degrees" shown on chart represent desired hold-open degree (on hold-open, friction, and stop only models) or stop degree (on SE models).
- "l" = Arm length from center to center (for reference only).
- On hold-open, friction, and stop only models, the dead stop (DS) degree is normally 5-7 degrees beyond the hold-open degree shown on chart. The DS door position is reached when the shock spring is fully compressed.
- When installing on doors which open back-to-back, or against a wall or obstruction, it may be desirable to install the holder based on the dead stop angle rather than the hold-open angle. To do this, add 13/16" (21mm) to the "A" dimension on chart. This will effectively reduce the dead stop and hold-open by 5-7 degrees. This can only be done on hold-open, friction, and stop only models, but NOT on SE models.

CAUTION: "A" & "B" dimensions are measured from the centerline of hinge, not edge of door.

GJ MODEL	DIM.	DOOR OPENING	85 degrees		90 degrees		95 degrees		100 degrees		105 degrees		110 degrees		C	I
			A	B	A	B	A	B	A	B	A	B	A	B		
902	IN.	23 1/16-27*	1 11/16*	4 5/8*	-	-	-	-	-	-	-	-	-	-	19 3/4	10
	mm	585-687	43	117	-	-	-	-	-	-	-	-	-	-	502	254
903	IN.	27 1/16-33	3 1/2	6 11/16	3 1/16*	6 1/4*	2 11/16*	5 7/8*	2 3/8*	5 9/16*	-	-	-	-	22	12
	mm	688-838	89	170	78	159	68	149	60	141	-	-	-	-	559	305
904	IN.	33 1/16-39	7	8 3/16	6 9/16	7 11/16	6 1/8	7 5/16	5 3/4	6 15/16	5 3/8	6 9/16	-	-	23 3/4	15 3/4
	mm	839-991	178	208	167	195	156	186	146	176	137	167	-	-	603	400
905	IN.	39 1/16-45	11 5/16	9	10 3/4	8 7/16	10 1/4	7 15/16	9 13/16	7 1/2	9 1/2	7 3/16	9 1/8	6 13/16	24 1/2	20
	mm	992-1143	287	229	273	214	260	202	249	191	241	183	232	173	622	508
906	IN.	45 1/16-54	17 1/4	10 7/16	16 5/8	9 3/4	16	9 3/16	15 1/2	8 11/16	15 1/8	8 1/4	14 3/4	7 15/16	26	26
	mm	1144-1372	438	265	422	248	406	233	394	221	384	210	375	202	660	660
902	IN.	23 1/16-27*	1 15/16*	4 7/8*	1 5/8*	4 9/16*	-	-	-	-	-	-	-	-	19 3/4	10
	mm	585-687	49	124	41	116	-	-	-	-	-	-	-	-	502	254
903	IN.	27 1/16-33	3 5/8	6 13/16	3 1/4*	6 7/16*	2 7/8*	6 1/16*	2 9/16*	5 3/4*	2 5/16*	5 1/2*	-	-	22	12
	mm	688-838	92	173	83	164	73	154	65	146	59	140	-	-	559	305
904	IN.	33 1/16-39	7 3/16	8 3/8	6 11/16	7 7/8	6 5/16	7 1/2	5 15/16	7 1/8	5 9/16	6 3/4	5 5/16	6 1/2	23 3/4	15 3/4
	mm	839-991	183	213	170	200	160	191	151	181	141	171	135	165	603	400
905	IN.	39 1/16-45	11 1/2	9 1/8	10 15/16	8 5/8	10 7/16	8 1/16	10	7 11/16	9 5/8	7 5/16	9 5/16	7	24 1/2	20
	mm	992-1143	292	232	278	219	265	205	254	195	244	186	237	178	622	508
906	IN.	45 1/16-54	17 7/16	10 5/8	16 3/4	9 15/16	16 3/16	9 3/8	15 11/16	8 7/8	15 1/4	8 3/8	14 7/8	8 1/16	26	26
	mm	1144-1372	443	270	425	252	411	238	398	225	387	213	378	205	660	660
902	IN.	23 1/16-27*	2 1/8	5 1/16	1 13/16	4 3/4	1 9/16	4 1/2	-	-	-	-	-	-	19 3/4	10
	mm	585-687	54	129	46	121	40	114	-	-	-	-	-	-	502	254
903	IN.	27 1/16-33	3 13/16	7	3 3/8	6 9/16	3 1/16*	6 1/4*	2 3/4*	5 15/16*	2 1/2*	5 11/16*	-	-	22	12
	mm	688-838	97	178	86	167	78	159	70	151	64	144	-	-	559	305
904	IN.	33 1/16-39	7 3/8	8 9/16	6 7/8	8 1/16	6 7/16	7 5/8	6 1/16	7 1/4	5 3/4	6 15/16	5 7/16	6 5/8	23 3/4	15 3/4
	mm	839-991	187	217	175	205	164	194	154	184	146	176	138	168	603	400
905	IN.	39 1/16-45	11 5/8	9 5/16	11 1/16	8 3/4	10 5/8	8 1/4	10 3/16	7 13/16	9 13/16	7 1/2	9 1/2	7 3/16	24 1/2	20
	mm	992-1143	295	237	281	222	270	210	259	198	249	191	241	183	622	508
906	IN.	45 1/16-54	17 5/8	10 13/16	16 15/16	10 1/16	16 3/8	9 1/2	15 7/8	9 1/16	15 7/16	8 9/16	15 1/16	8 1/4	26	26
	mm	1144-1372	448	275	430	256	416	241	403	230	392	217	383	210	660	660
902	IN.	27 1/16-33	2 13/16	5 3/4	2 1/2	5 7/16	2 3/16	5 1/8	2	4 15/16	1 3/4	4 11/16	1 9/16	4 1/2	19 3/4	10
	mm	688-838	71	146	64	138	56	130	51	125	44	119	40	114	502	254
903	IN.	33 1/16-39	4 5/16	7 7/16	3 15/16	7 1/8	3 9/16	6 3/4	3 1/4	6 7/16	3	6 3/16	2 3/4	5 15/16	22	12
	mm	839-991	110	189	100	181	90	171	83	164	76	157	70	151	559	305
904	IN.	39 1/16-45	7 7/8	9	7 3/8	8 9/16	6 15/16	8 1/8	6 9/16	7 3/4	6 1/4	7 7/16	6	7 1/8	23 3/4	15 3/4
	mm	992-1143	200	229	187	217	176	206	167	197	159	189	152	181	603	400
905	IN.	45 1/16-51	12 1/4	9 15/16	11 11/16	9 3/8	11 3/16	8 7/8	10 3/4	8 3/8	10 3/8	8	10 1/16	7 3/4	24 1/2	20
	mm	1144-1295	311	252	297	238	284	225	273	213	264	203	256	197	622	508
906	IN.	51 1/16-57	18 1/4	11 7/16	17 9/16	10 3/4	17	10 1/16	16 7/16	9 9/16	16	9 1/8	15 9/16	8 3/4	26	26
	mm	1296-1448	464	291	446	273	432	256	418	243	406	232	395	222	660	660

*Not to be used with swing clear hinges.

5 Mark "B" dimension (from chart) on frame. Note that "B" dimension is measured from centerline of hinge as shown.

6 Cut out "Jamb Bracket Template" from bottom of page and align on frame to locate 4 holes to drill.

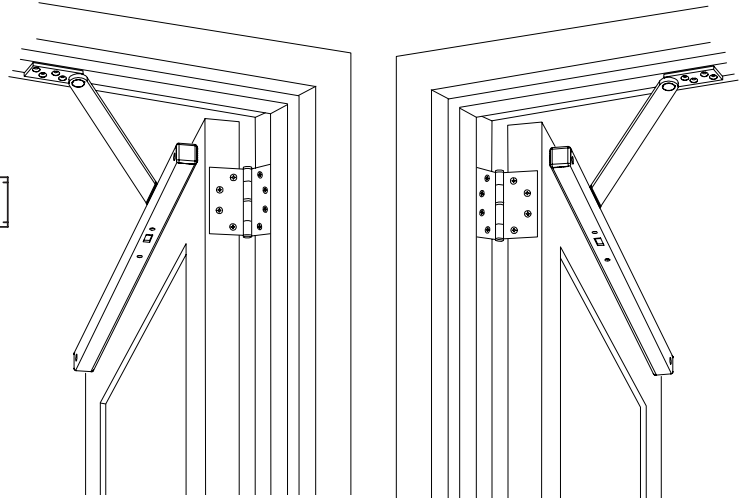
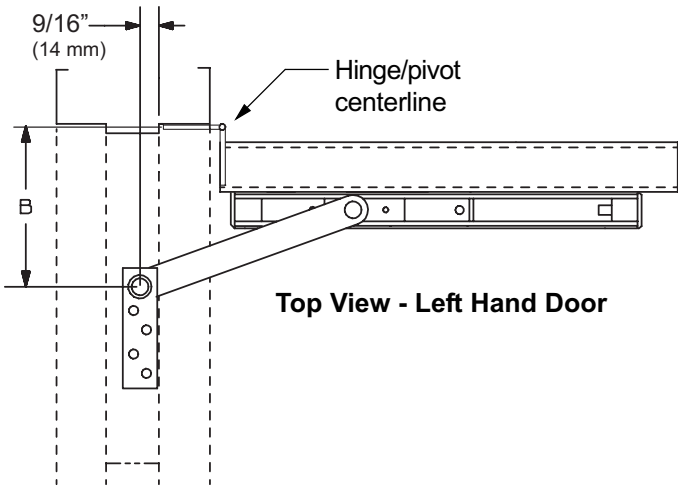

Right Hand Door

Left Hand Door

7 Locate and mark "A" and "C" dimensions on door. Note that "A" dimension is measured from centerline of hinge as shown. For dead stop add 13/16" (21mm) to the "A" dimension from the chart. For more information about dead stop, see page 2 under "Notes on using chart".

8 Drill two 3/8" (10mm) diameter through holes per chart and dimensions shown below. Mounting holes should be prepared only after door and frame are installed.

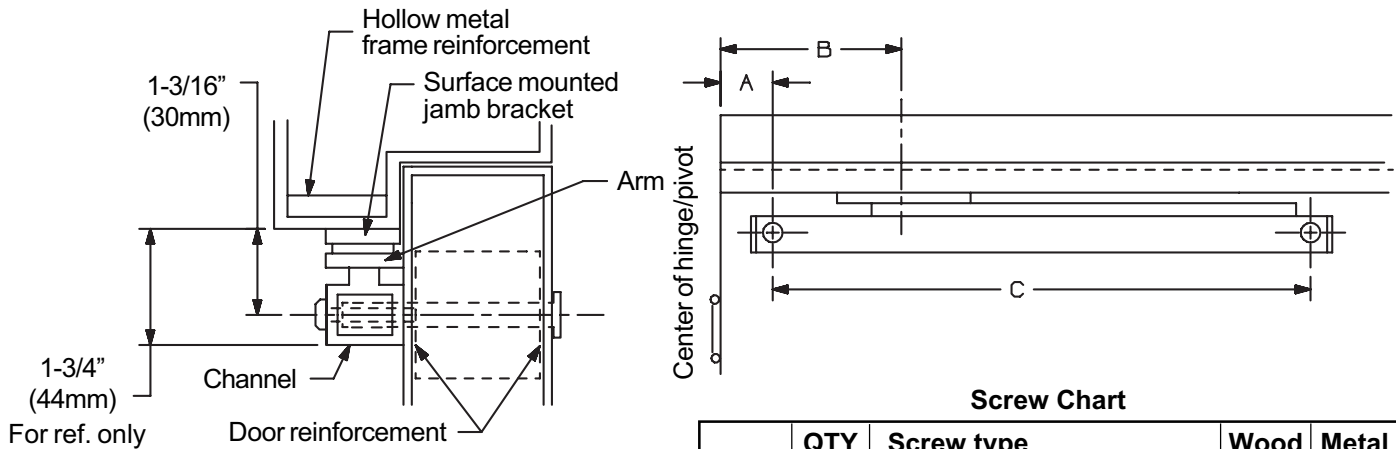

	QTY	Screw type	Wood	Metal
Jamb	4	#14 x 1-1/2" FPHSMS	✓	
	4	1/4"-20 x 3/4" FPHMS		✓
Door	2	1/4"-20 x 1-1/4" OPHMS	✓	✓
	2	1/4"-20 x 2-1/2" Sex bolts	✓	✓

9 Install jamb bracket on the stop (see Screw Chart).

10 Install the channel on the door (see Screw Chart)
Shock spring should be located on hinge end of the door.

Jamb Bracket Template (actual size)

