

VR880/VR884 VANDAL RESISTANT TRIM

FOR USE WITH OTHER MANUFACTURERS' RIM AND VERTICAL EXIT DEVICES

- 1** PREPARE PUSH SIDE OF DOOR FOR EXIT DEVICE. SEE EXIT DEVICE INSTRUCTIONS FOR PREPARATION.
- 2** PREPARE PULL SIDE OF DOOR FOR TRIM.
 - A** TRANSFER VERTICAL AND HORIZONTAL DEVICE CENTER LINES FROM PUSH SIDE OF DOOR TO PULL SIDE.
 - B** LOCATE AND PREPARE ALL HOLES AS INDICATED BELOW.

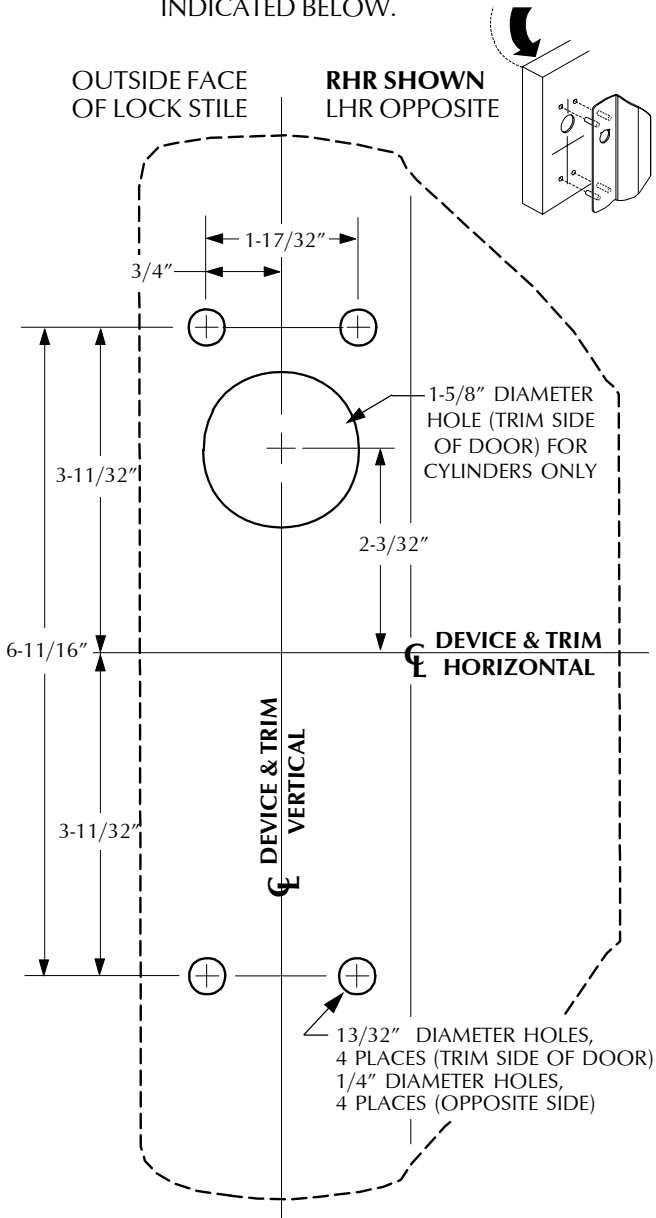

- 3** IF USING A CYLINDER SECURE CYLINDER TO TRIM.

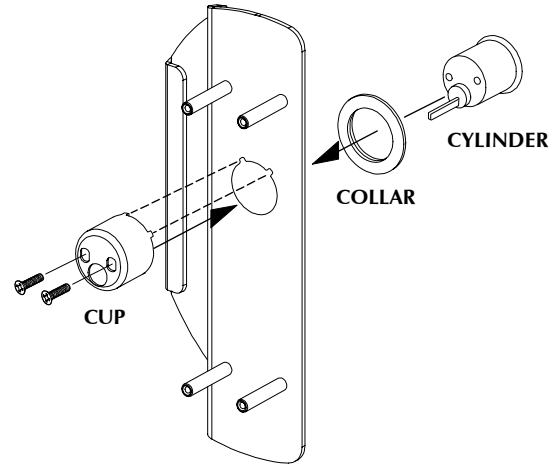

- 4** INSTALL EXIT DEVICE AND TRIM.

