



23654

Model 7982



Control Box

Installation Instructions

For closer information see closer installatin instruction sheet

Typical Electric & Air Supply Hook Up

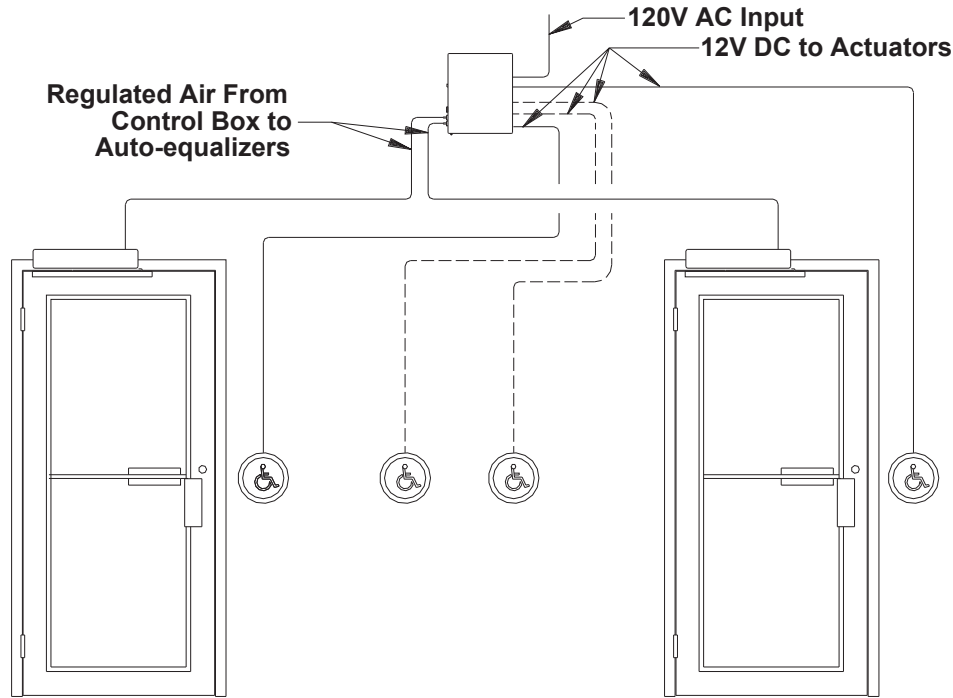

Installation

| | |
|---|--|
| <p>1a Locate box on interior of building within 50 tubing feet of the farthest door to be controlled. Box must be in a clean, dry, well ventilated place where temperatures do not exceed 120°F or fall below 35°F.</p> | <p>1f Air pressure output has been preset at factory. If more air pressure is required to adequately open doors, regulate air adjustment valve on pump, as shown on page 3.</p> |
| <p>1b Mount box to a structurally sound surface using screws provided as shown on page 2 with air fittings on left side as shown. Do not mount box upside down or on a horizontal plane.</p> | <p>1g Adjust time delay to keep air valve energized by turning adjustment wheel on timer modules "A" & "B" (CW to increase - CCW to decrease). The LED (light) on the timer module indicates the valve is energized. The time can be adjusted from 0-30 seconds. 10 seconds is a "normal" delay.</p> |
| <p>1c Refer to instructions packed with actuators and connect leads to terminals 6, 8, 9, and 10 as required.</p> | <p>ⓘ NOTICE: Timer Module "A" and "B" must operate longer than Time Module "P".</p> |
| <p>1d Connect unpowered 120V AC input to terminals 3, 4, and ground screw. (Line side to terminal 3, neutral side to terminal 4 and ground wire to ground screw.) If door control is on a fire door, 120V AC input must be interrupted by the fire alarm panel when in alarm. When dry auxiliary fire alarm contacts are used, remove shunt from terminals 1 and 2 and connect to dry contacts of fire detector or alarm panel. Terminals 1 and 2 are in series with line side of 120V input.</p> | <p>1h Adjust timer module "P" to keep compressor activated for the necessary amount of time to open the door. This can be done by rotating the adjusting wheel. (CW to increase - CCW to decrease). The LED (light) on the timer module indicates the compressor is energized. The compressor should not run more than 1-3 seconds longer than the time required to open the door.</p> |
| <p>1e Turn on power. Air valves and compressor will operate one cycle when power is applied.</p> | <p>1i Test actuators to insure wiring and tubing are properly connected.</p> |

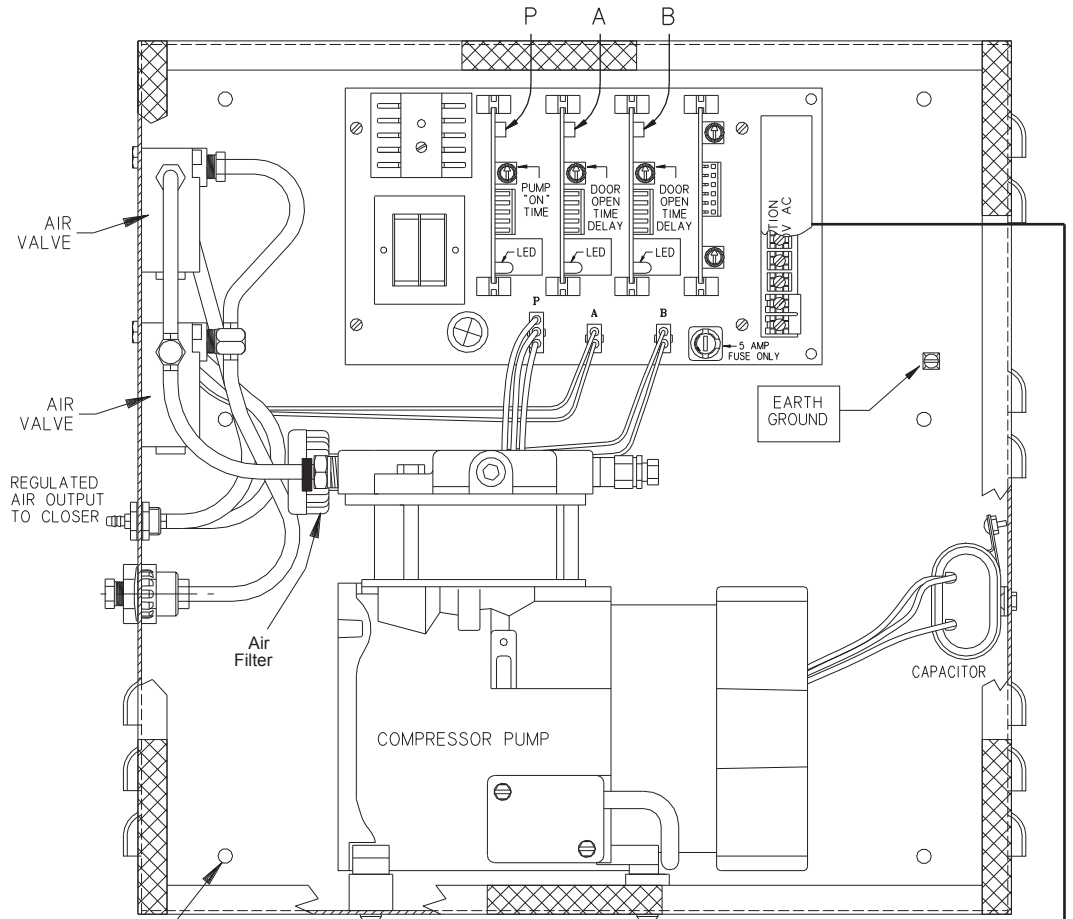
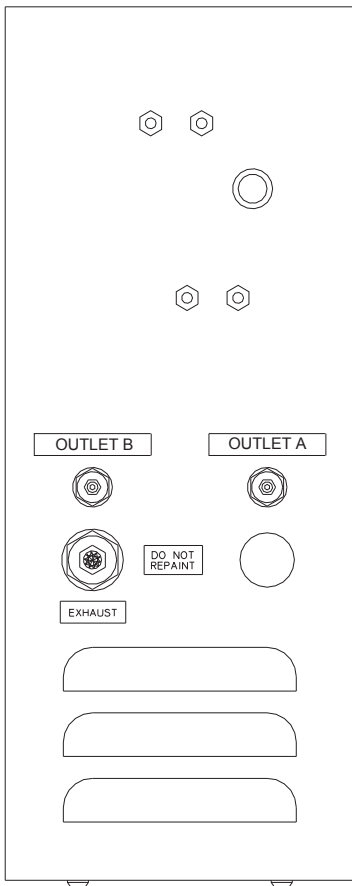

CAUTION

Do not mount box upside Down or in horizontal Position. Locate where Temperatures do not Exceed 120°F or fall Below 35°F

CAUTION

Components inside control Box will be hot to touch Under normal operation. Allow box to cool down Before making adjustments.

WARNING



Hazardous voltage Can shock and Cause severe injury

Disconnect power before Making any electrical Connections or performing Maintenance.

Electrical Data

Input = 120V AC @ 5 amps
 Power consumption 600watts
 Output is 12V DC (250 ma max.Load)

Air filter should be Inspected every six Months.If filter is Damaged, contact LCN For replacement.

Install box with six tapcon Concrete screws 3/16 x 1 1/4 Drill 5/32 hole 1 1/4 deep With carbide tipped Concrete drill bit

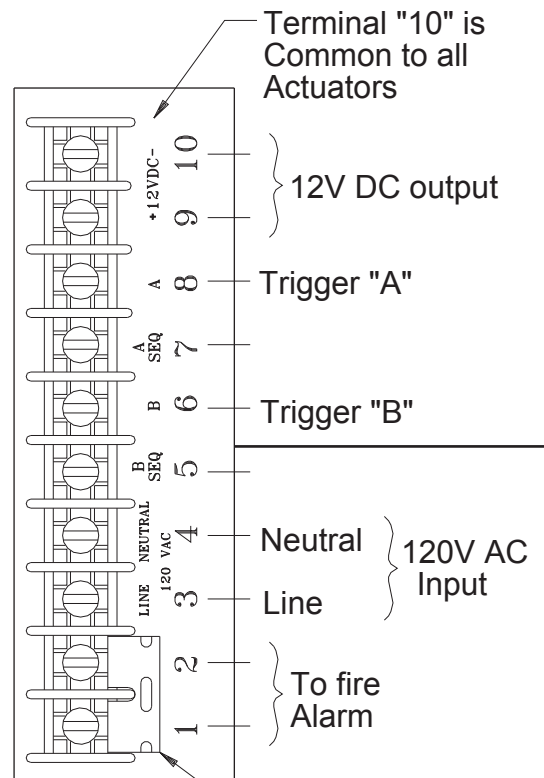

* Remove this shunt Only when connecting To normally closed Fire alarms contacts

DANGER Control box MUST be connected to earth ground

Air Pressure Adjustment

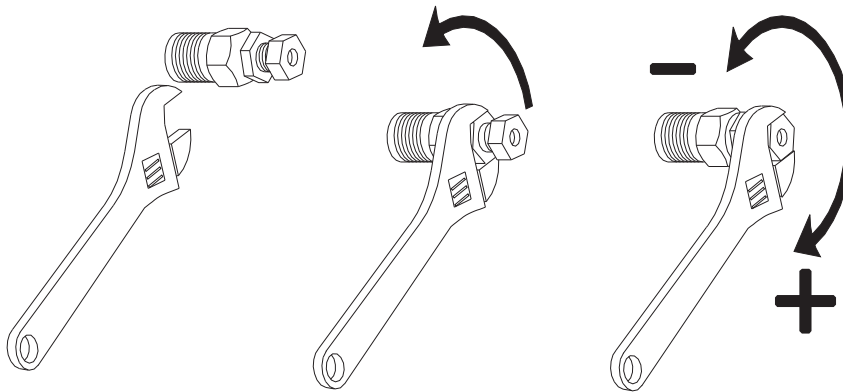
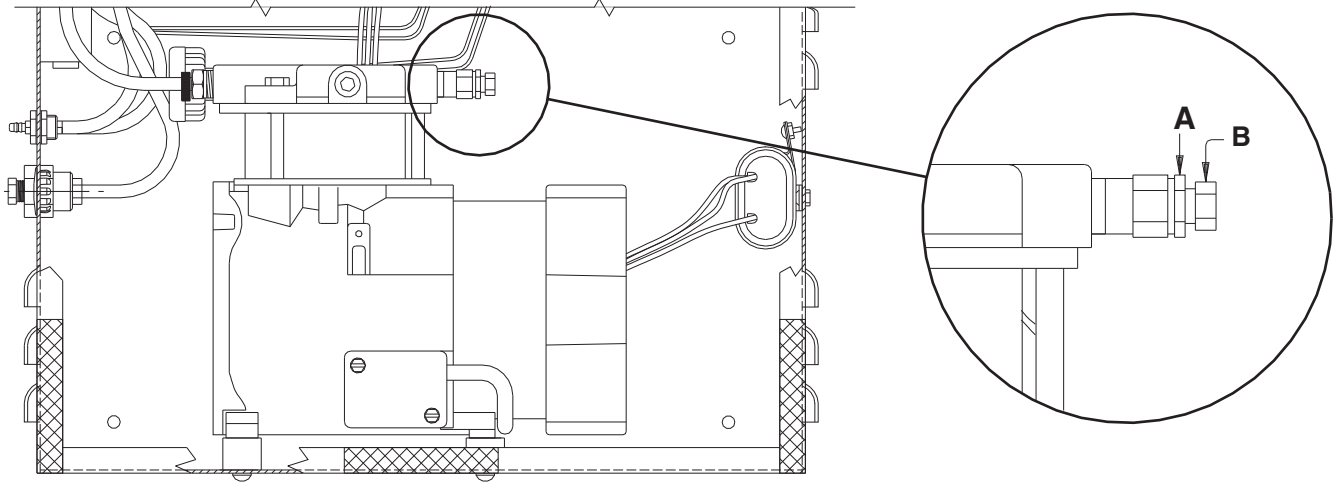

Air Pressure Adjustment

- 1a Loosen lock nut. (A)
- 1b Turn outer valve (B) to regulate air pressure.
- 1c Tighten lock nut.

Installation Troubleshooting Chart

| Symptom | Possible Cause | Suggested Remedy |
|------------------------------|---|--|
| No Power Opening | No power to control box / blown fuse | Verify 120VAC 60HZ power is present at terminals 3 & 4 on control box terminal strip. Check fuse. Replace only with 5 amp (3AG type) fuse. |
| | Actuator(s) not connected properly | Be sure a timer module board is firmly in place in "A", "B" & "P" slots. Operate actuator(s) LED on timer module should light when actuator is used. The LED on timer "P" should light whenever "A" or "B" is lit. If not, momentarily short actuator terminals 6 & 10 and 8 & 10 in the control box. If LED lights, check wiring to actuators for an open circuit. If it does not light, check for voltage at terminals 9 & 10. Voltage should read from 11.75 to 13.25V DC. If there is no reading, disconnect leads from terminals 9 & 10. Short actuator terminals 6 & 10 and 8 & 10. If LED lights, check for short circuit in actuators. |
| | Fire alarm system causing open circuit on terminals 1 & 2 | Shunt terminals 1 & 2 with power off. Restore power. If control operates when actuator terminals in the control box are shorted, an open circuit exist in wiring to fire alarm. When Auto-Equalizer is not used with fire alarms, terminals 1 & 2 must be permanently shorted with a shunt. IMPORTANT! When Auto-Equalizer is connected to fire alarm, make sure shunt is removed from terminals 1 & 2. Terminals 1 & 2 are one leg of 120V line. |
| | No input to Auto-Equalizer operator | Disconnect tubing from Auto-Equalizer operator. Try actuator and verify that air is coming out of tubing. If not, trace tubing to control box, checking for breaks or kinks in air line. |
| | Air lines obstructed with dirt or ice. | Clean or thaw lines and reroute if necessary. Eliminate dips near cold zones. |
| | Air valves not working | Make sure air valve leads are plugged into main board. (Be sure valves in system are plugged into connectors "A" & "B".) |
| | Compressor not working | Make sure compressor leads are plugged into main board. (Be sure compressor is plugged into connector "P"). |
| | Does not open or fully open | Control box exhaust restricted. |
| Opens too slow or not at all | Inlet filter clogged | Replace filter element (Contact LCN for replacement) |

| Symptom | Possible Cause | Suggested Remedy |
|------------------------------------|--|---|
| Power opening will not time out. | Scanner maintaining signal to control box. | Make sure lenses are clean and there are no obstructions in front of scanner. Model 909 or 939 proximity scanner may "see" an opposite wall. Adjust range as described earlier. |
| | Switch circuit maintaining contact. | Check for short circuit or error in wiring to switch or scanner. |
| | Air valve blocked open with contaminant. | Cycle valve several times by momentarily shorting actuators in the control box. This should clear valve. |
| Power opening timing out too soon. | Air compressor needs readjustment. | See page 2 for regulation instructions. |
| | Timer cards not set properly | Set timer cards "A" & "B" for Max. time. Set timer card "P" for Min. time. Slowly increase card "P" until "time-out" is 1-3 seconds after door is fully open. Decrease timer card "A" & "B" to achieve desired time delay before closing. (Make sure "P" times out before "A" & "B".) |

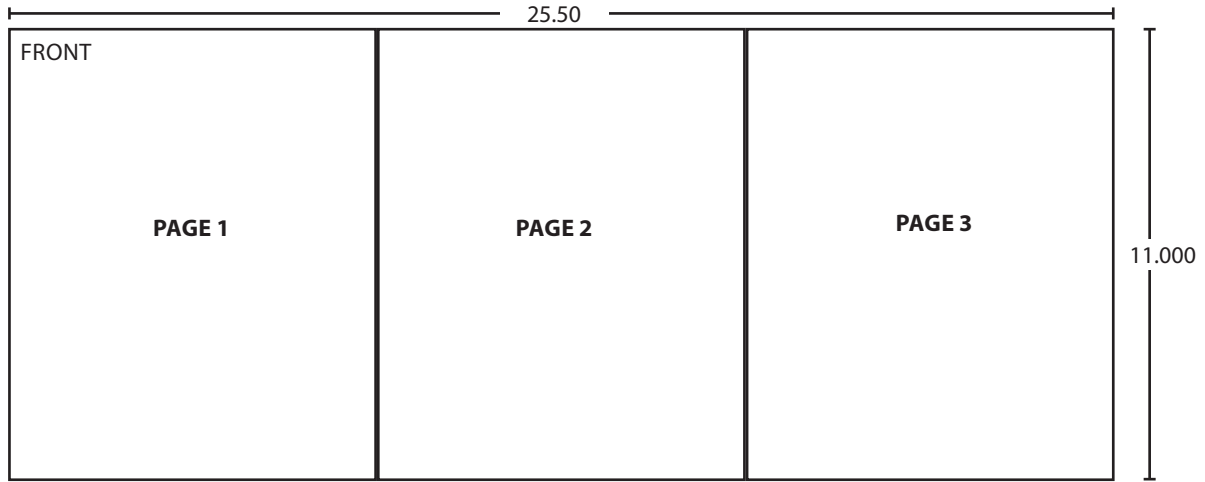

BEGINNING SHEET

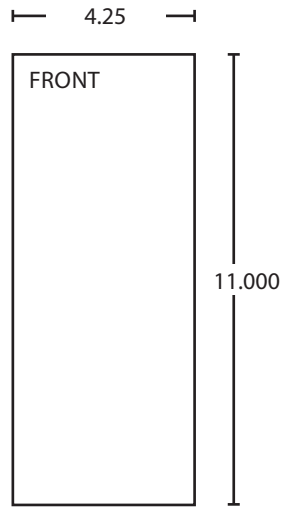
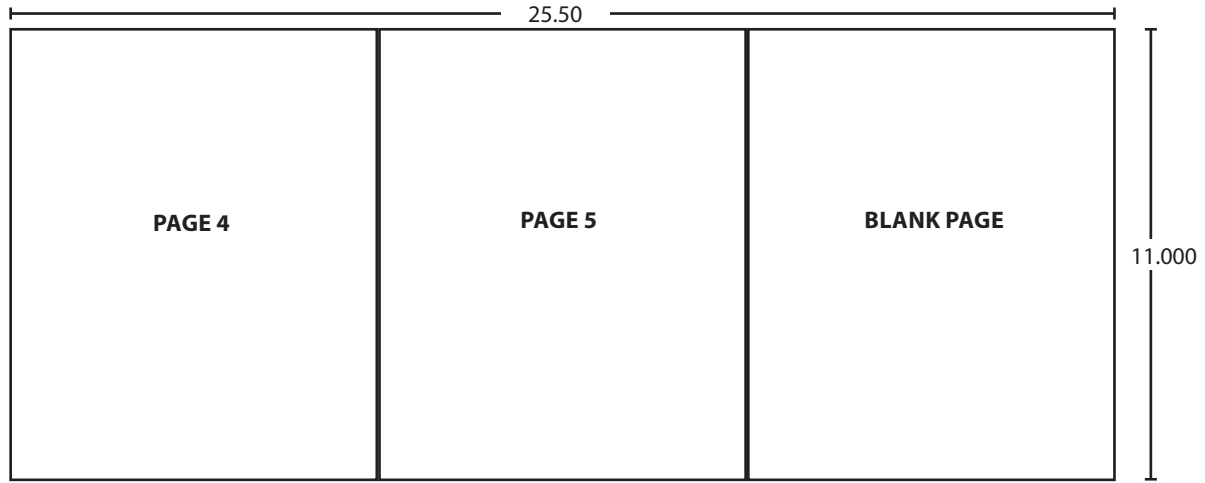

FOLDED SHEET

| |
|--------------------------|
| Additional Notes: |
| 1. None |

| | | | | | | | | | | | |
|---|---|---|---|---|---|---|--|--|--|----------------------|--------------|
| Revision History | | | | | | Revision Description: E > Revised artwork | | | | | |
| E | F | G | H | J | K | | | | | | |
| 043228 | | | | | | | | | | | |
| Material White Paper | | | | | | Edited By | | Approved By | | EC Number | Release Date |
| | | | | | | D. Myers | | M. Sasso | | 043228 | 01-01-14 |
| Notes 1. printed two sides 2. printed black 3. tolerance ± .13 4. printed in country may vary 5. drawings not to scale | | | | | | Title 7982 Series Control Box Instruction Sheet | | | | | |
| | | | | | | Creation Date 04-27-10 | | Number 23654 | | Revision E | |
| | | | | | | Created By N/A | | Activity 3899 Hancock Expwy Security, CO 80911 | | © Allegion 2014 | |
| | | | | | | Software: InDesign CS6 | | | | | |