



AD-Series Retrofit Template Overlays



Contents

- | | | | |
|----|---------------------------------|----|---|
| 2 | Alarm Lock Trilogy | 33 | VIP 5100 (2 of 2) |
| 3 | Best 5-6-8-9K | 34 | Alarm Lock DL3500 (1 of 2) |
| 4 | Best BASIS 93KBV | 35 | Alarm Lock DL3500 (2 of 2) |
| 5 | Best IDH-MAX | 36 | Corbin ML2000 |
| 6 | Cal-Royal CR3000 | 37 | Kaba E5700 |
| 7 | Cal-Royal PL7000 | 38 | Onity-HT |
| 8 | Cal-Royal RS2000 | 39 | Persona 4000R / 5000R (1 of 2) |
| 9 | Kaba 1000 (Lockout function) | 40 | Persona 4000R / 5000R (2 of 2) |
| 10 | Kaba 1000 (Passage function) | 41 | Sargent 7900 Series Lock Body Only |
| 11 | Kaba 5000 | 42 | Sargent Profile Series Mortise (1 of 2) |
| 12 | Kaba L1000 | 43 | Sargent Profile Series Mortise (2 of 2) |
| 13 | Onity-HT | 44 | Schlage CM5600 (1 of 2) |
| 14 | Sargent 6/7-GX-11 Line | 45 | Schlage CM5600 (2 of 2) |
| 15 | Sargent 8/9 Line | 46 | Schlage CM-CL-PRO-5500 (1 of 2) |
| 16 | Sargent 10 Line | 47 | Schlage CM-CL-PRO-5500 (2 of 2) |
| 17 | Sargent 7500 | 48 | Schlage CO-100/200-MS/MD |
| 18 | Sargent DL-8-9 | 49 | Schlage KC5500 |
| 19 | Sargent Profile 10G77 (1 of 2) | 50 | Schlage L/LV-9486 |
| 20 | Sargent Profile 10G77 (2 of 2) | 51 | Schlage MPM / 5500 |
| 21 | Schlage CL5200-CM5200 (1 of 2) | 52 | Schlage WA5600 (1 of 2) |
| 22 | Schlage CL5200-CM5200 (2 of 2) | 53 | Schlage WA5600 (2 of 2) |
| 23 | Schlage CM5100-HW (1 of 2) | 54 | Stanley 45H / HW-47H / HW-IDH |
| 24 | Schlage CM5100-HW (2 of 2) | 55 | Best Exit Trim (on Von Duprin 98/99 Rim) |
| 25 | Schlage CM-CL-PRO-5100 (1 of 2) | 56 | Kaba E-Plex 5700 Exit (on Von Duprin 98/99 Rim) |
| 26 | Schlage CM-CL-PRO-5100 (2 of 2) | 57 | Sargent Profile Exit Trim (on Sargent 8800 Rim) |
| 27 | Schlage CO-100/200-CY | 58 | Schlage CO-100/200-993 Exit (on Von Duprin 98/99 Rim) |
| 28 | Schlage KC5100 | 59 | Schlage Pro 993 Exit (on Von Duprin 98/99 Rim) |
| 29 | Schlage ND Series | 60 | Schlage WA993 Exit (on Von Duprin 98/99 Rim) |
| 30 | Schlage WA5200 (1 of 2) | 61 | Decorative Plates |
| 31 | Schlage WA5200 (2 of 2) | | |
| 32 | VIP 5100 (1 of 2) | | |

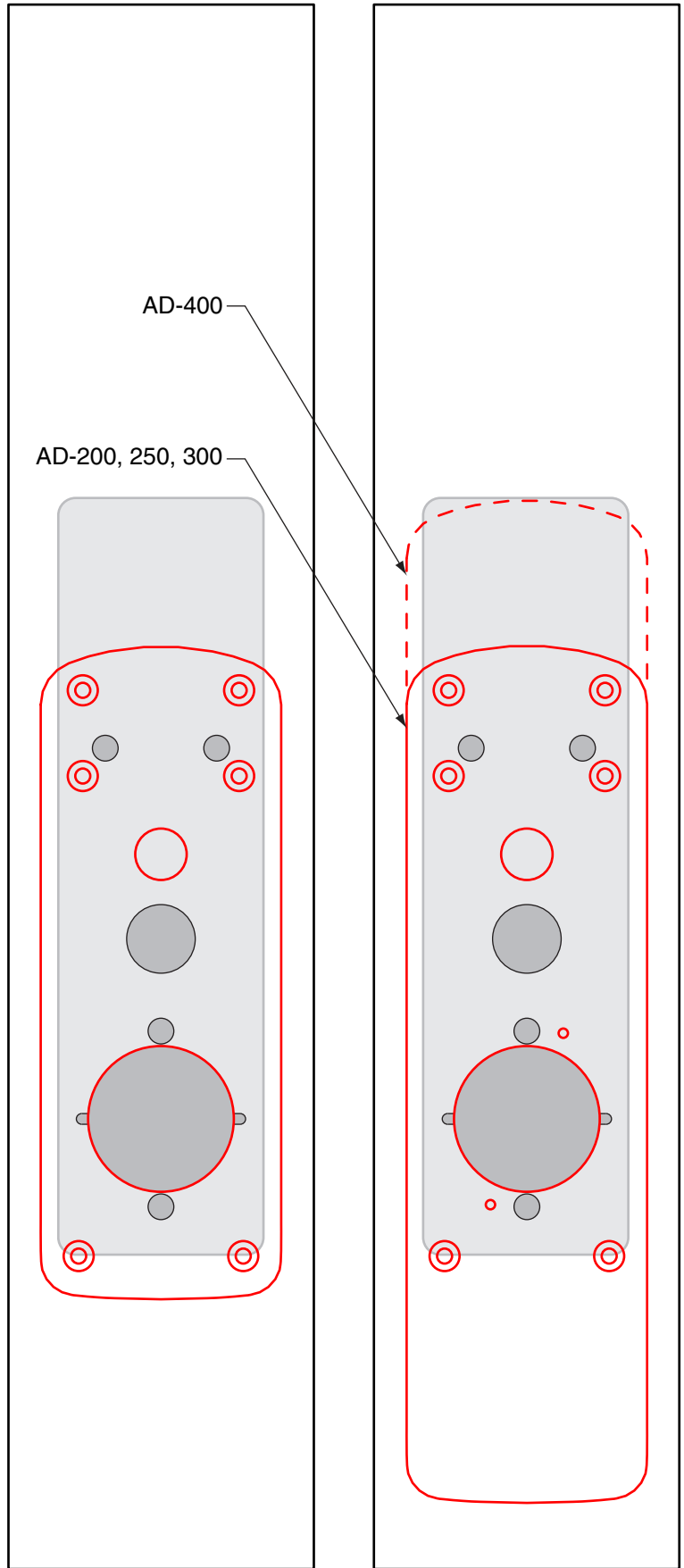

Alarm Lock Trilogy

	Retrofitting From: Alarm Lock Trilogy (All Cylindrical)
	To New Lock: Schlage AD-200-CY Schlage AD-250-CY Schlage AD-300-CY Schlage AD-400-CY
	Decorative Plates Required: n/a



Outside Face of Door

Inside Face of Door

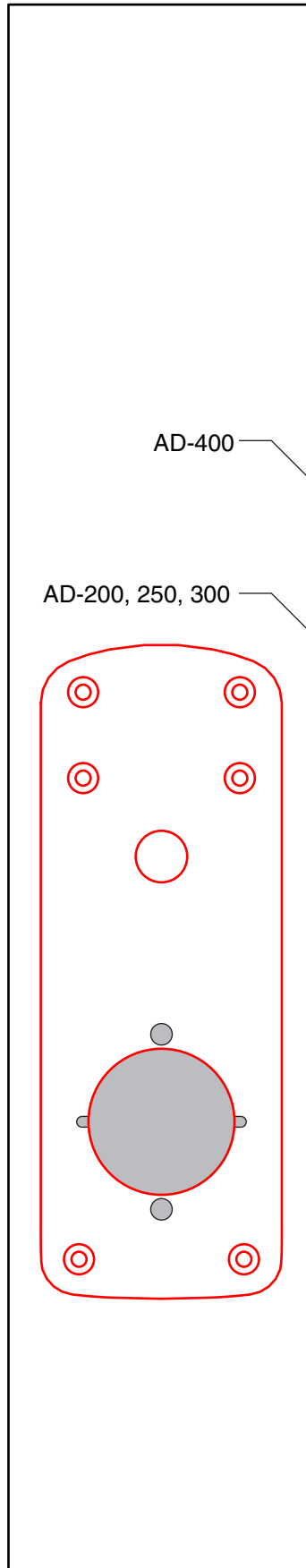

	Retrofitting From: Best 5-6-8-9K
	To New Lock: Schlage AD-200-CY Schlage AD-250-CY Schlage AD-300-CY Schlage AD-400-CY
	Decorative Plates Required: n/a

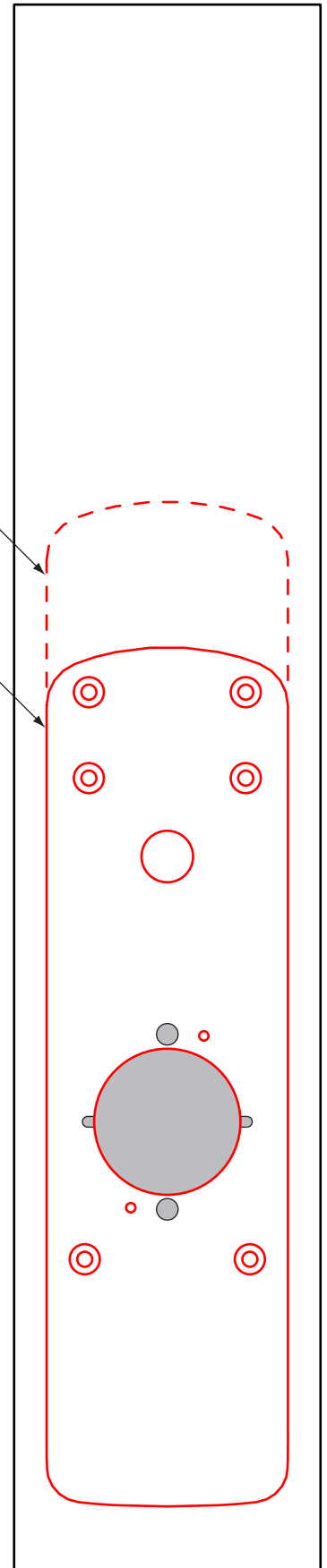

Outside Face of Door



Inside Face of Door

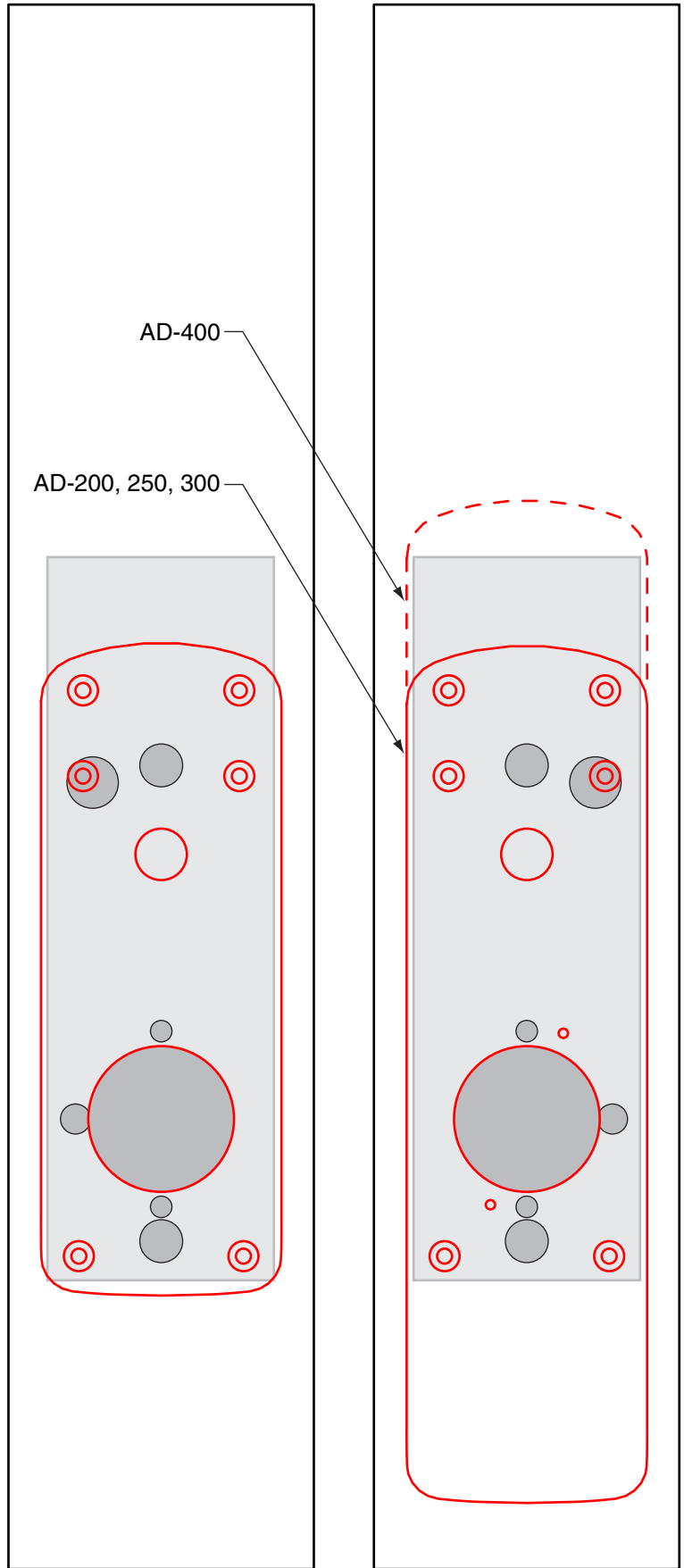

	Retrofitting From: Best BASIS 93KBV
	To New Lock: Schlage AD-200-CY Schlage AD-250-CY Schlage AD-300-CY Schlage AD-400-CY
	Decorative Plates Required: n/a



Outside Face of Door

Inside Face of Door

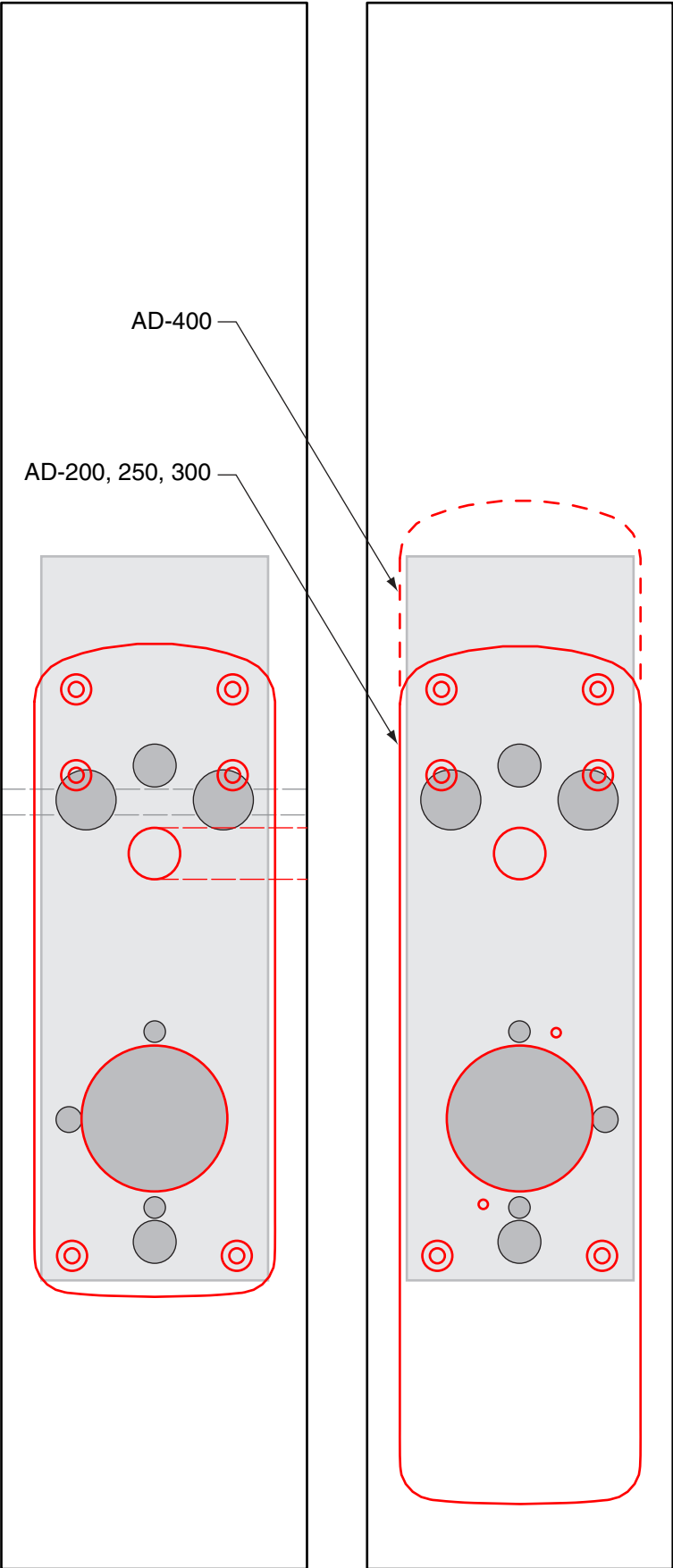

Best IDH-MAX

	Retrofitting From: Best IDH-MAX
	To New Lock: Schlage AD-200-CY Schlage AD-250-CY Schlage AD-300-CY Schlage AD-400-CY
	Decorative Plates Required: n/a



Outside Face of Door

Inside Face of Door

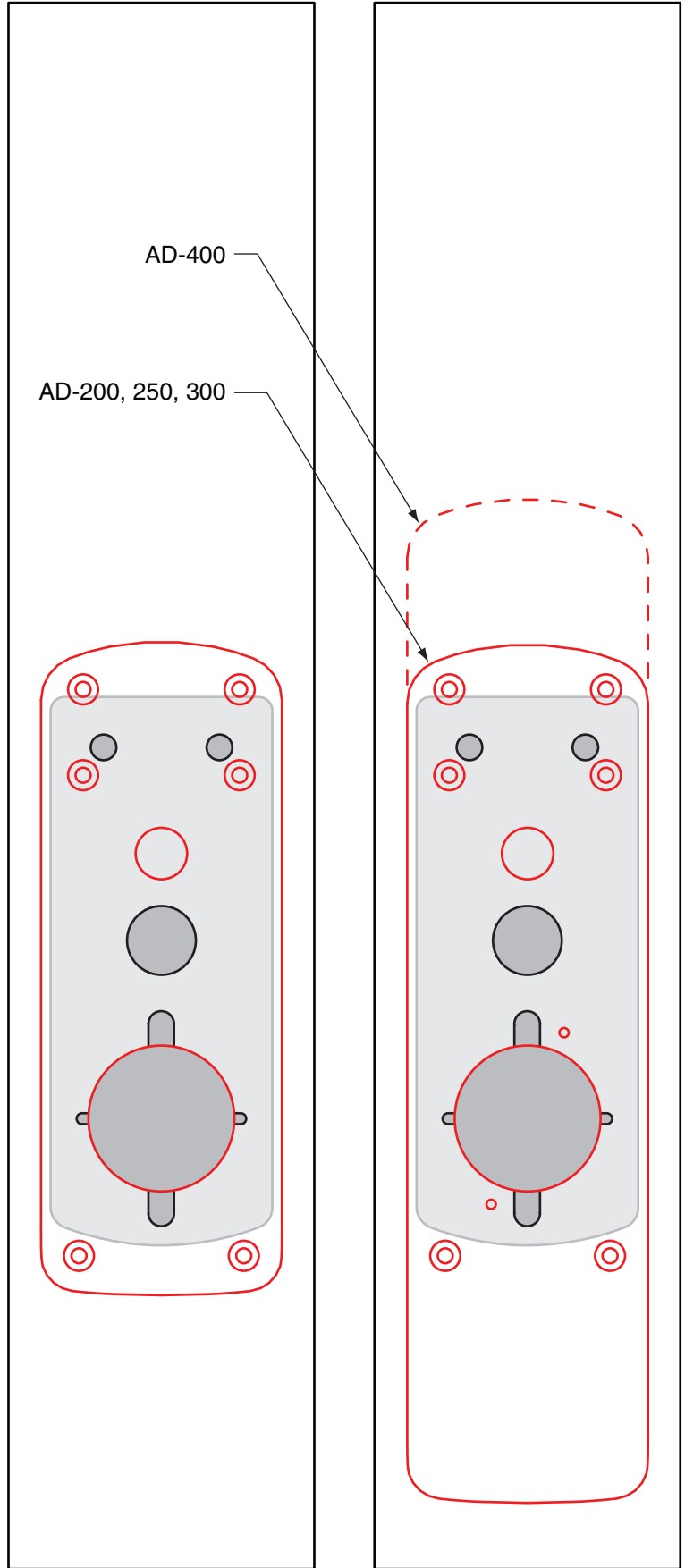

	Retrofitting From: Cal-Royal CR3000
	To New Lock: Schlage AD-200-CY Schlage AD-250-CY Schlage AD-300-CY Schlage AD-400-CY
	Decorative Plates Required: n/a



Outside Face of Door

Inside Face of Door

Cal-Royal PL7000

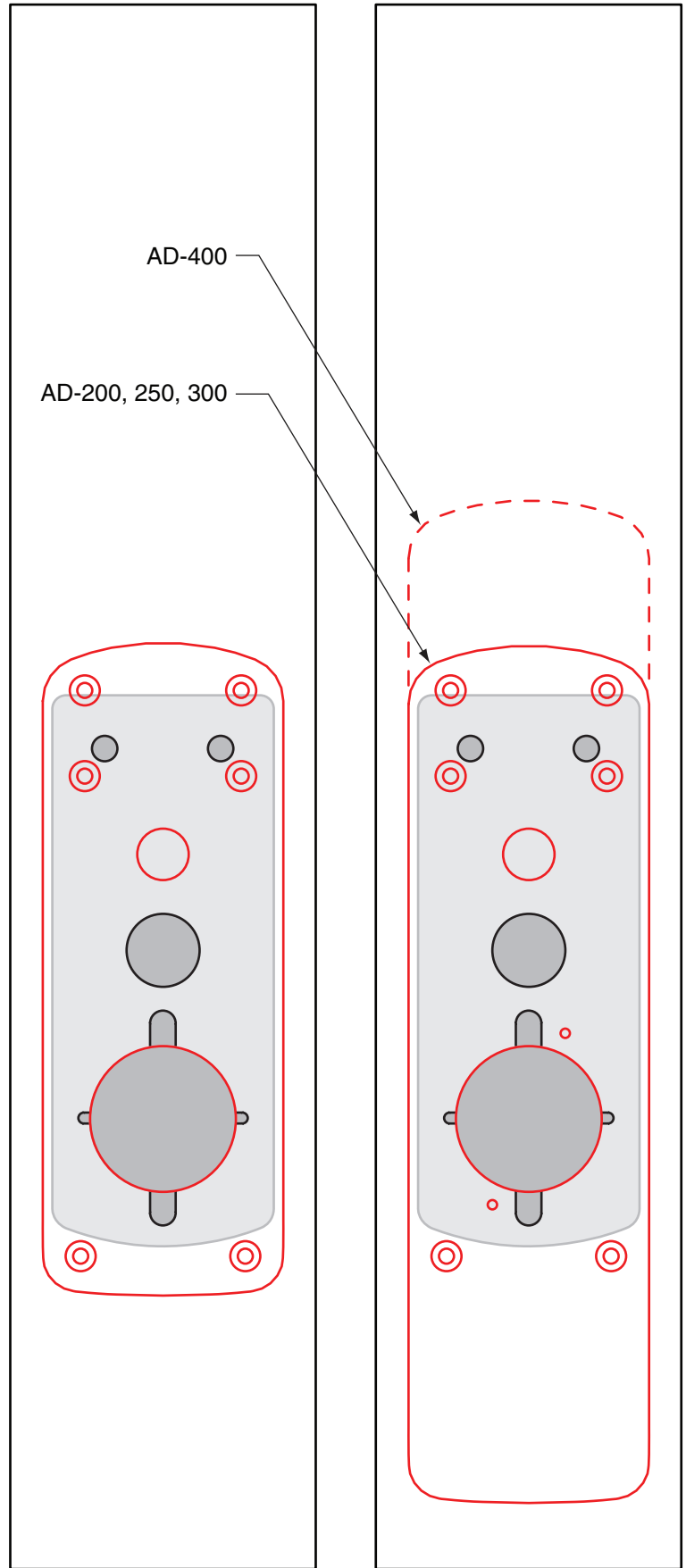

	Retrofitting From: Cal-Royal PL7000
	To New Lock: Schlage AD-200-CY Schlage AD-250-CY Schlage AD-300-CY Schlage AD-400-CY
	Decorative Plates Required: n/a



Outside Face of Door

Inside Face of Door

Cal-Royal RS2000

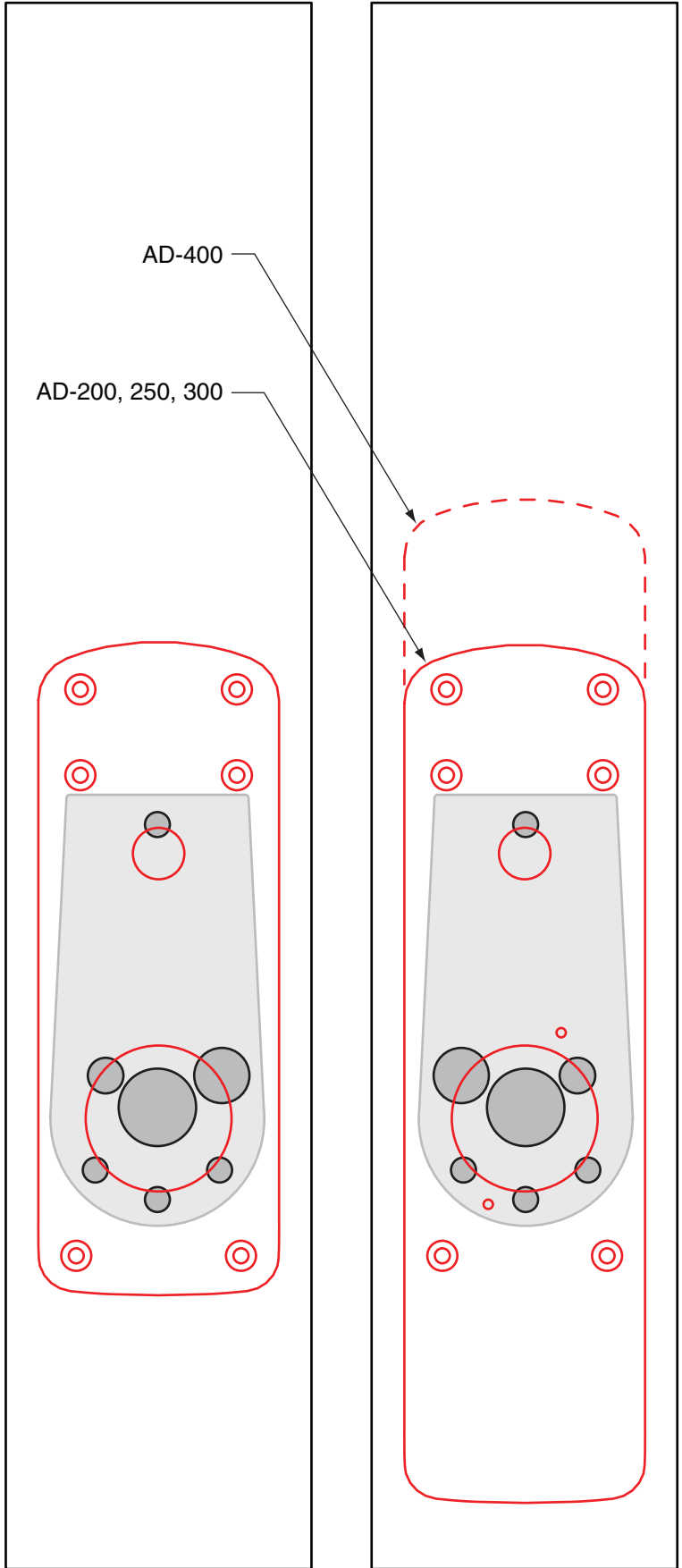

	Retrofitting From: Cal-Royal RS2000
	To New Lock: Schlage AD-200-CY Schlage AD-250-CY Schlage AD-300-CY Schlage AD-400-CY
	Decorative Plates Required: n/a



Outside Face of Door

Inside Face of Door

Kaba 1000 (Lockout function)

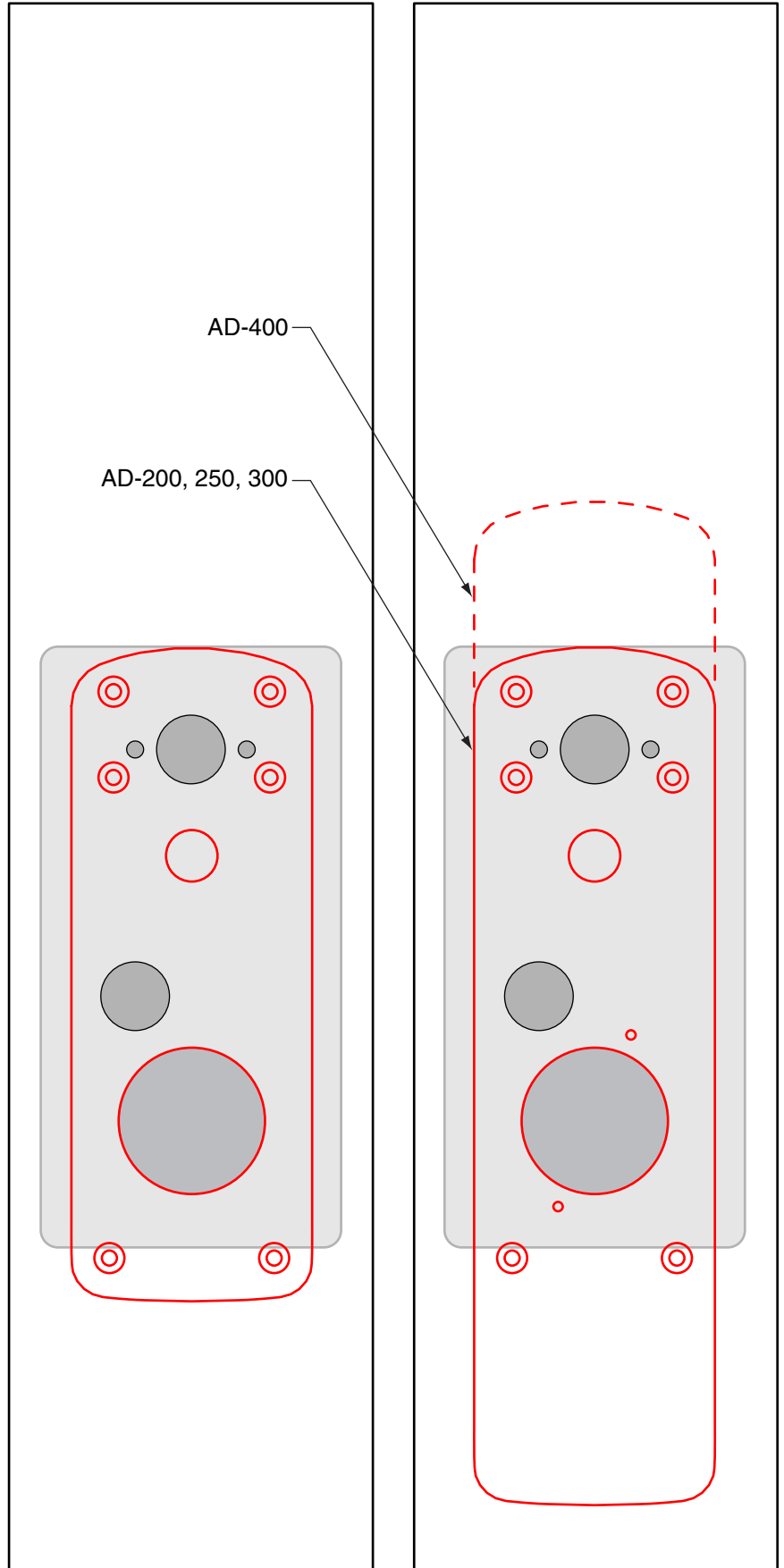

	Retrofitting From: Kaba 1000 (Lockout function)
	To New Lock: Schlage AD-200-CY Schlage AD-250-CY Schlage AD-300-CY Schlage AD-400-CY
	Decorative Plates Required: n/a



Outside Face of Door

Inside Face of Door

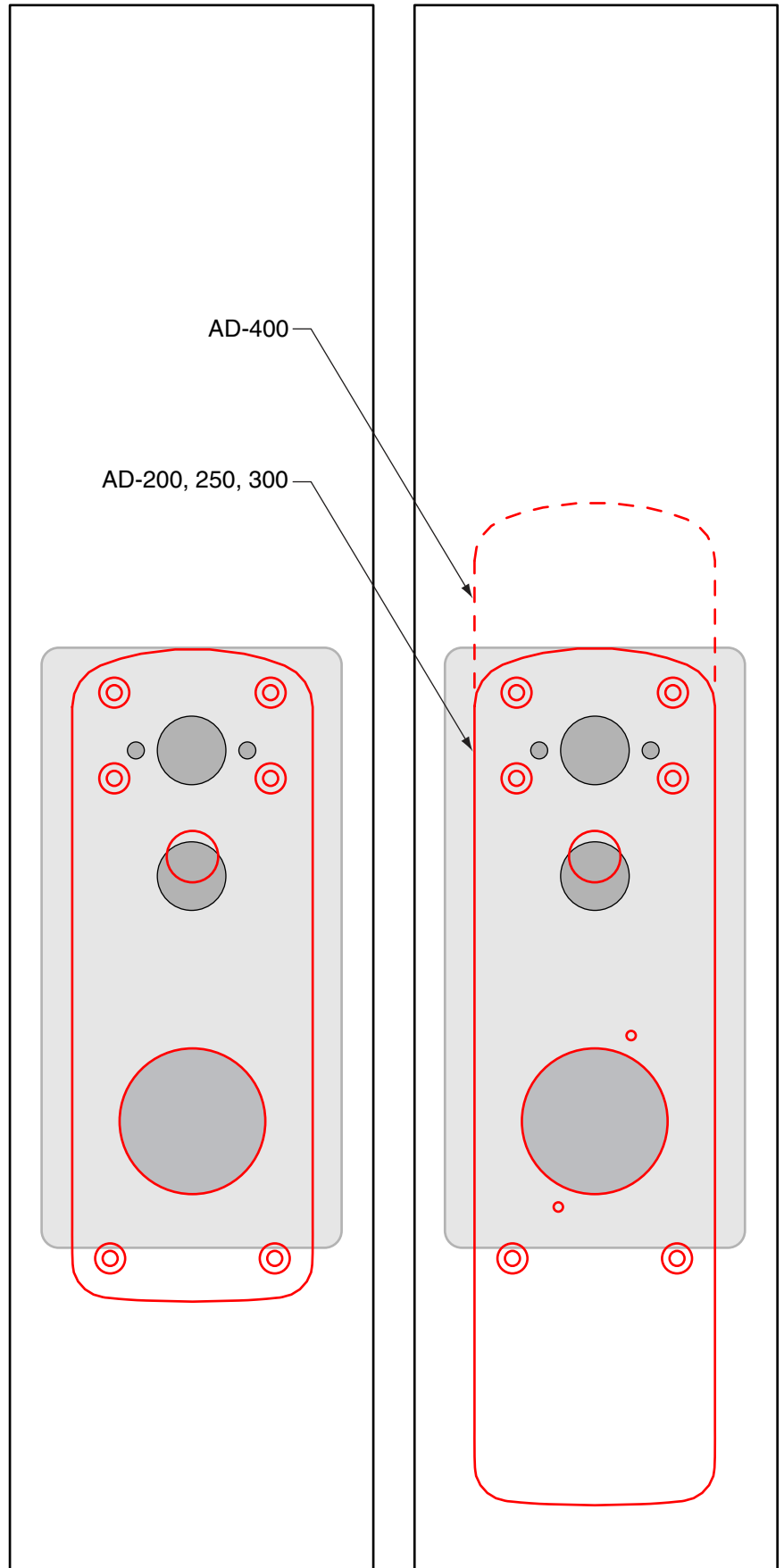

Kaba 1000 (Passage function)

	Retrofitting From: Kaba 1000 (Passage function)
	To New Lock: Schlage AD-200-CY Schlage AD-250-CY Schlage AD-300-CY Schlage AD-400-CY
	Decorative Plates Required: n/a



Outside Face of Door

Inside Face of Door

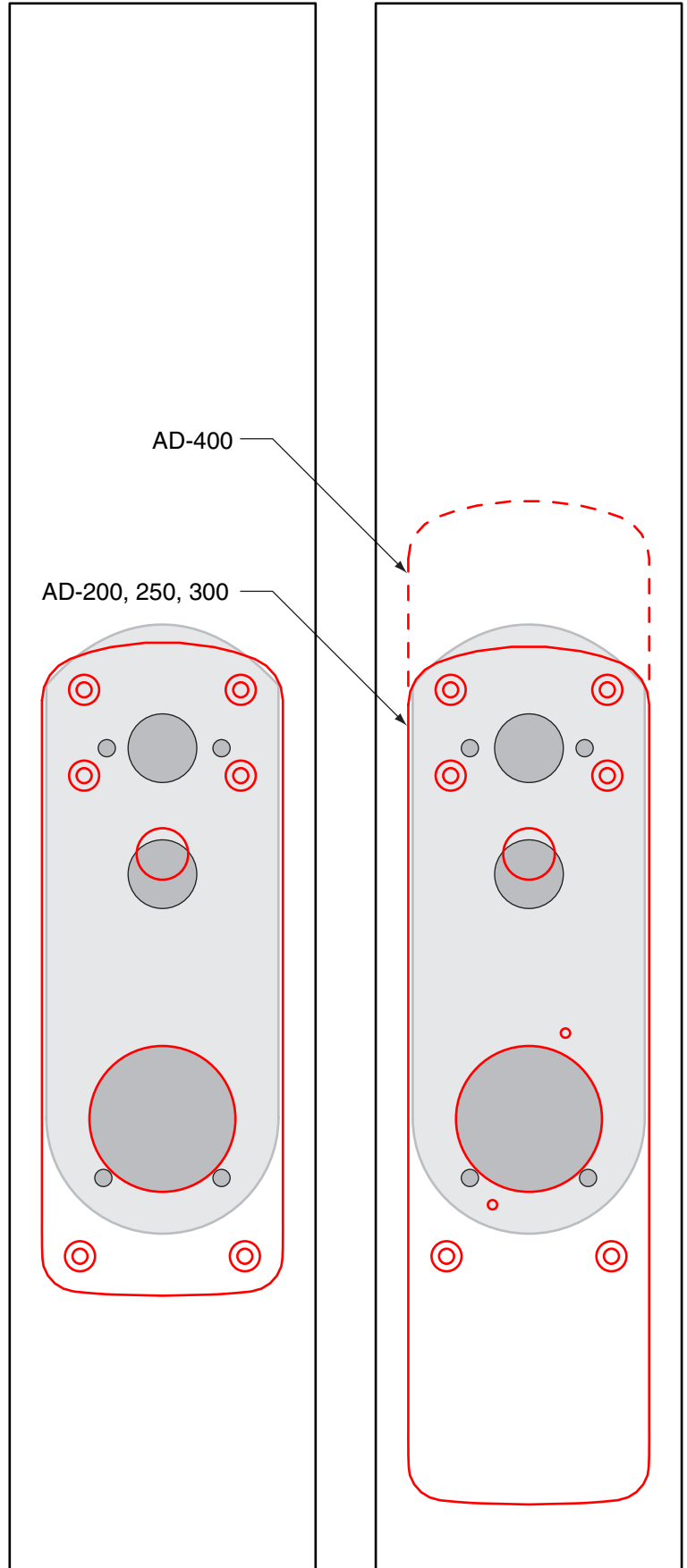

	Retrofitting From: Kaba 5000
	To New Lock: Schlage AD-200-CY Schlage AD-250-CY Schlage AD-300-CY Schlage AD-400-CY
	Decorative Plates Required: n/a



Outside Face of Door

Inside Face of Door

Kaba L1000

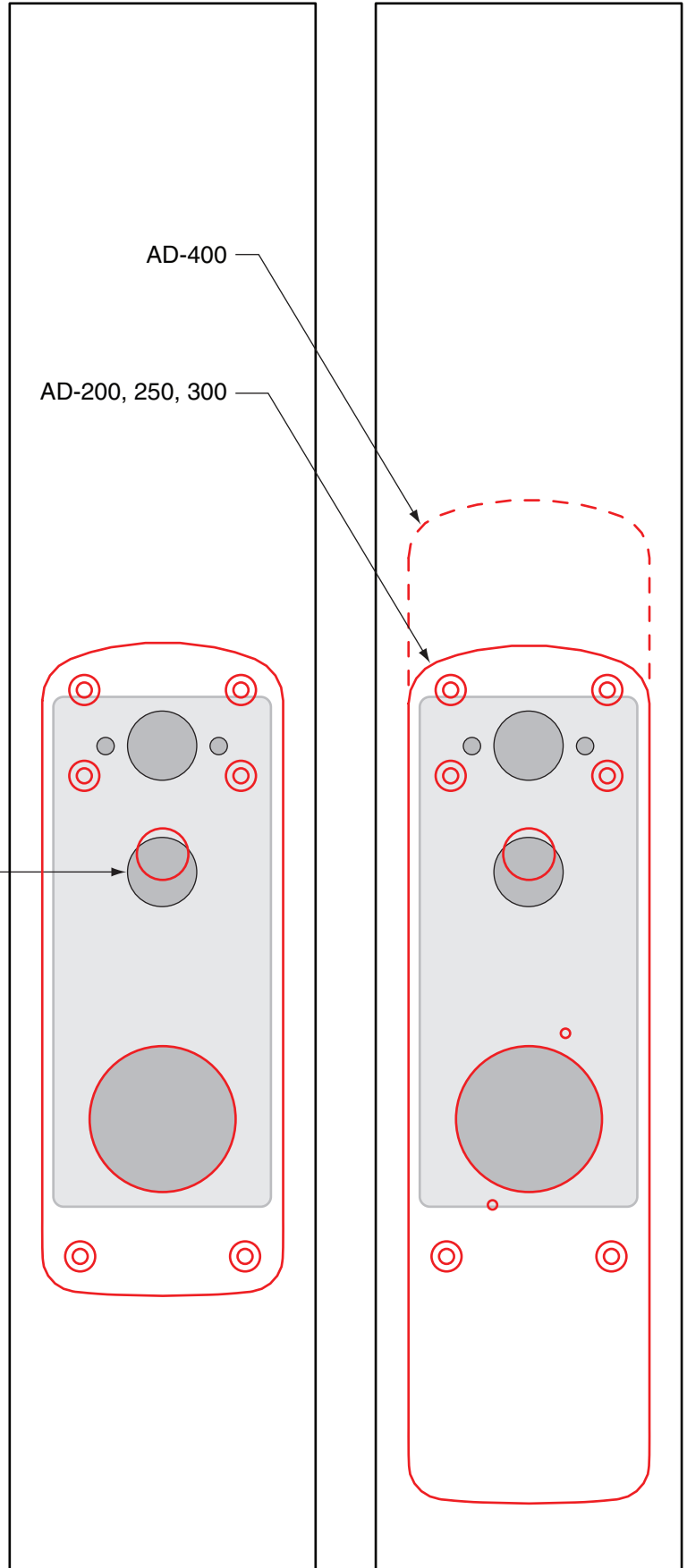

	Retrofitting From: Kaba L1000
	To New Lock: Schlage AD-200-CY Schlage AD-250-CY Schlage AD-300-CY Schlage AD-400-CY
	Decorative Plates Required: n/a



Outside Face of Door

Inside Face of Door

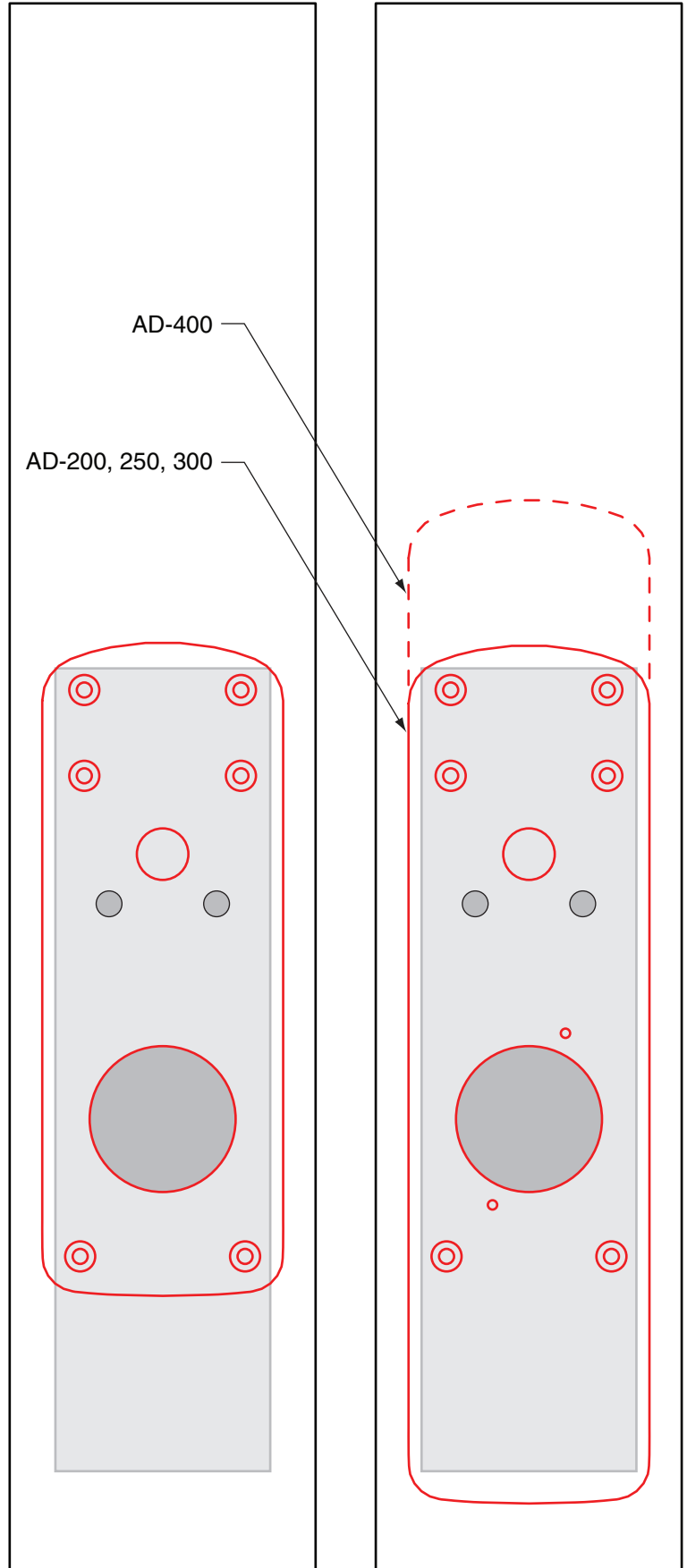

Onity-HT

	Retrofitting From: Onity-HT
	To New Lock: Schlage AD-200-CY Schlage AD-250-CY Schlage AD-300-CY Schlage AD-400-CY
	Decorative Plates Required: n/a



Outside Face of Door

Inside Face of Door

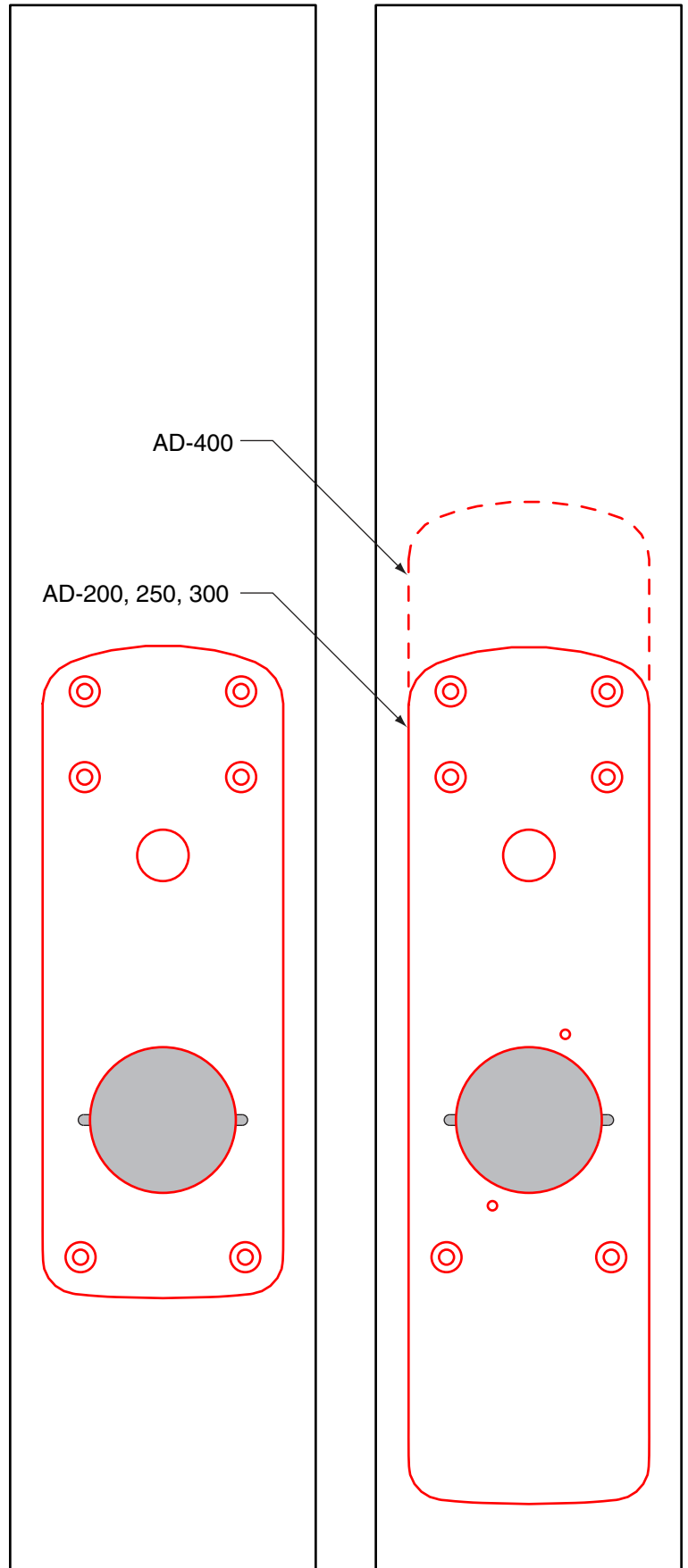

	Retrofitting From: Sargent 6/7-GX-11 Line
	To New Lock: Schlage AD-200-CY Schlage AD-250-CY Schlage AD-300-CY Schlage AD-400-CY
	Decorative Plates Required: n/a



Outside Face of Door

Inside Face of Door

Sargent 8/9 Line

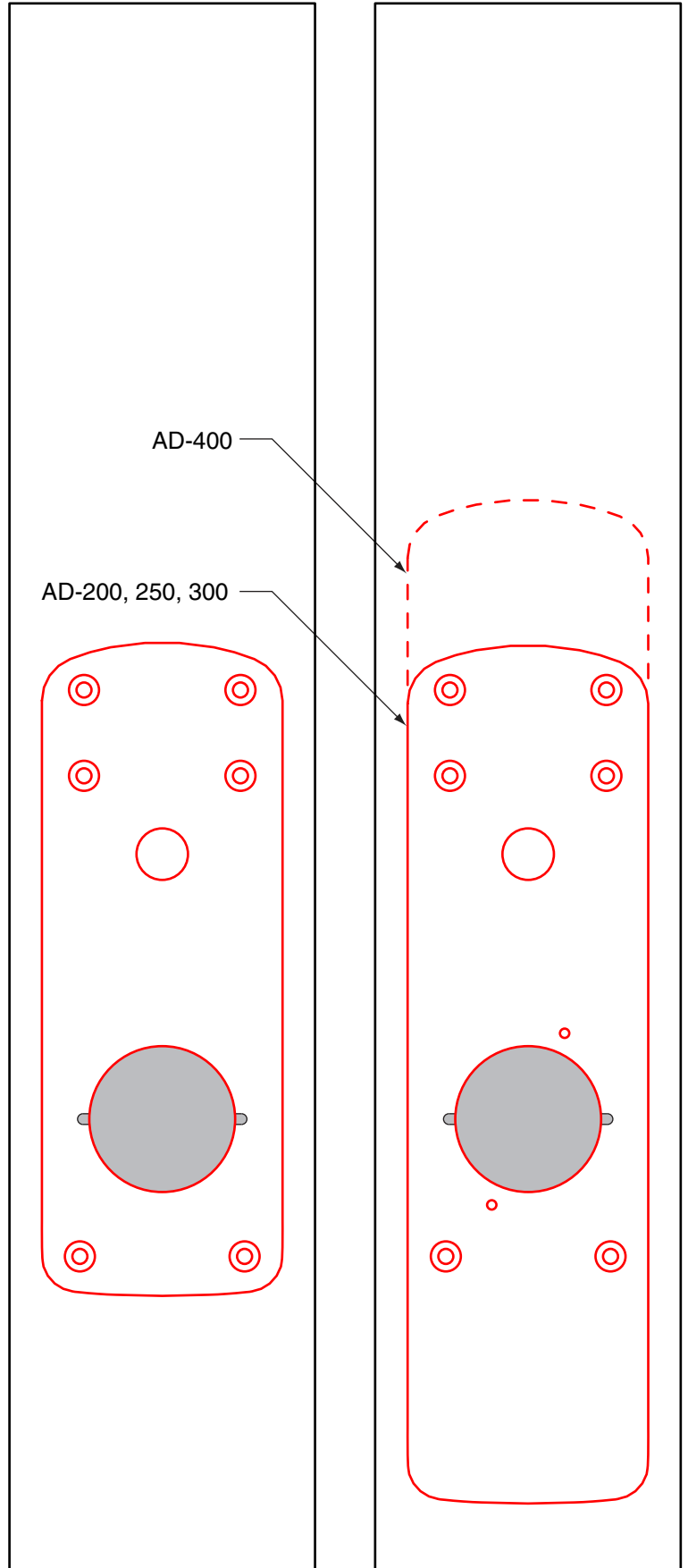

	Retrofitting From: Sargent 8/9 Line
	To New Lock: Schlage AD-200-CY Schlage AD-250-CY Schlage AD-300-CY Schlage AD-400-CY
	Decorative Plates Required: n/a



Outside Face of Door

Inside Face of Door

Sargent 10 Line

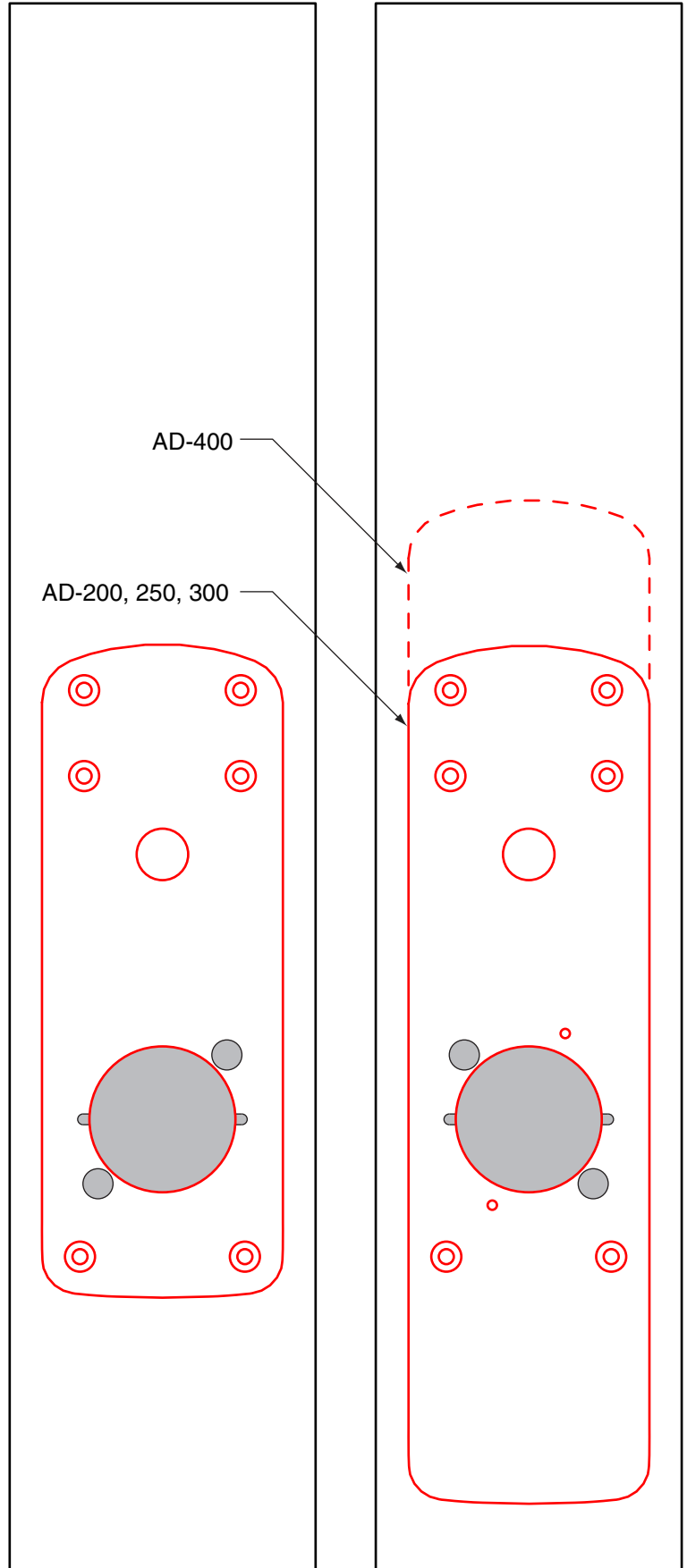

	Retrofitting From: Sargent 10 Line
	To New Lock: Schlage AD-200-CY Schlage AD-250-CY Schlage AD-300-CY Schlage AD-400-CY
	Decorative Plates Required: n/a



Outside Face of Door

Inside Face of Door

Sargent 7500

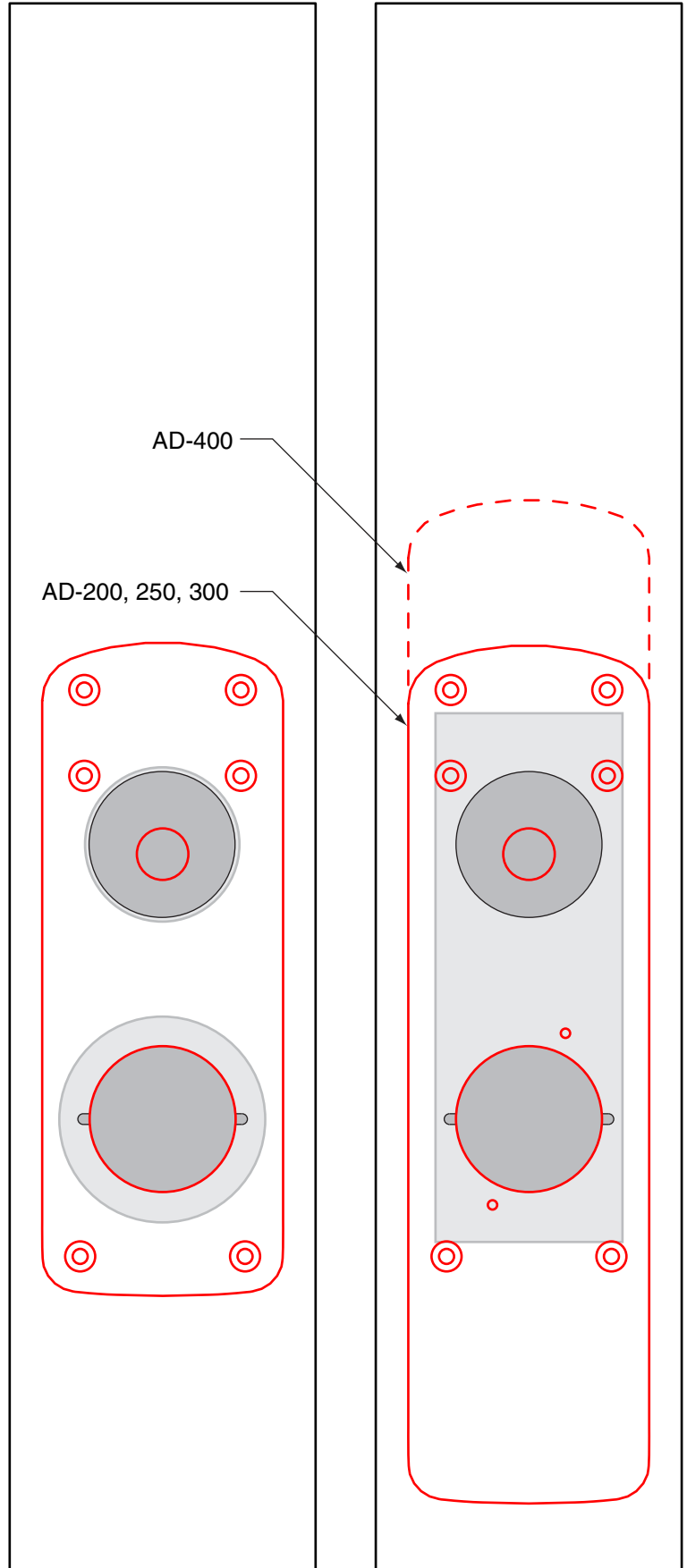

	Retrofitting From: Sargent 7500
	To New Lock: Schlage AD-200-CY Schlage AD-250-CY Schlage AD-300-CY Schlage AD-400-CY
	Decorative Plates Required: n/a



Outside Face of Door

Inside Face of Door



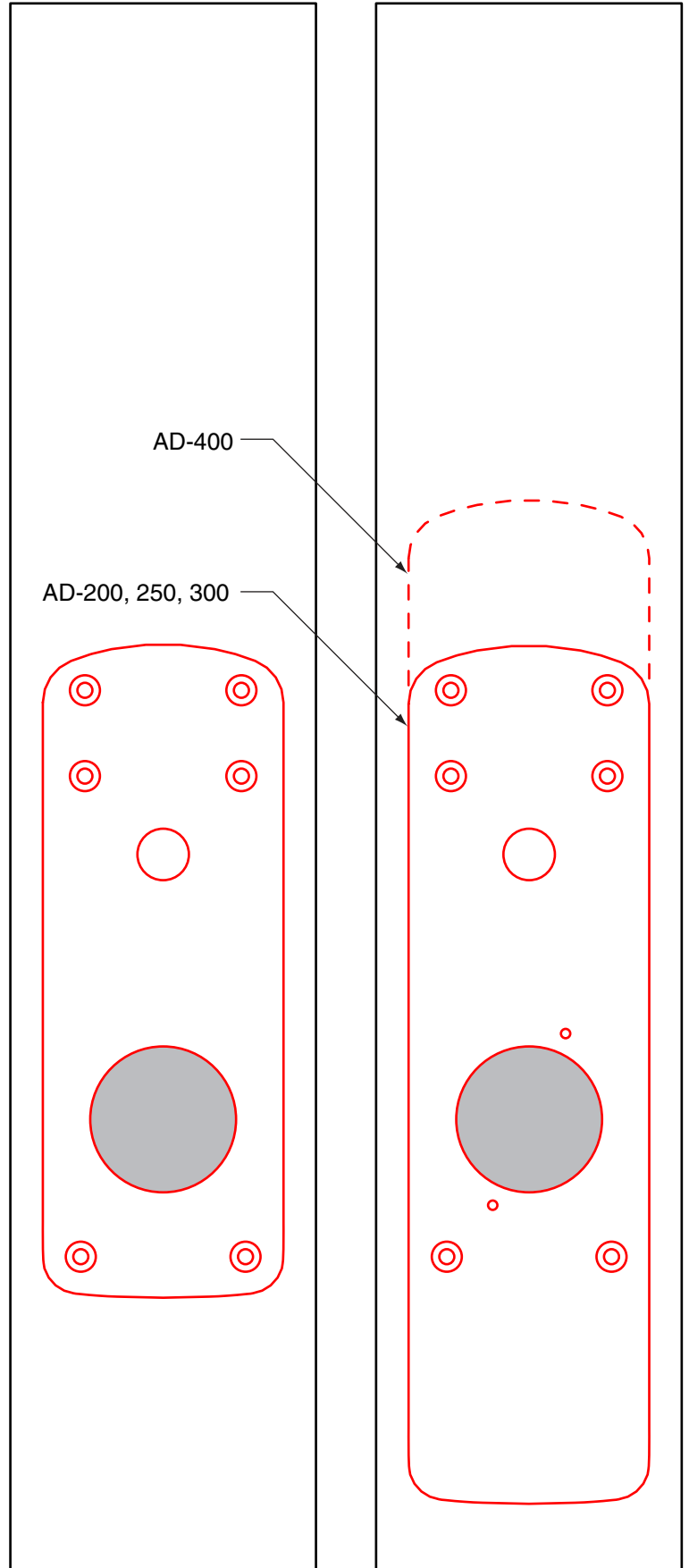

Sargent DL-8-9

	Retrofitting From: Sargent DL-8-9
	To New Lock: Schlage AD-200-CY Schlage AD-250-CY Schlage AD-300-CY Schlage AD-400-CY
	Decorative Plates Required: n/a

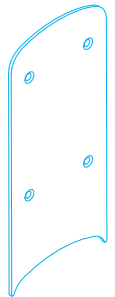
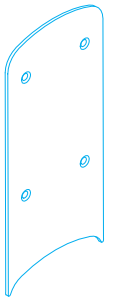

Outside Face of Door

Inside Face of Door

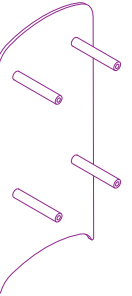
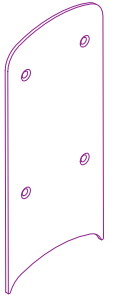

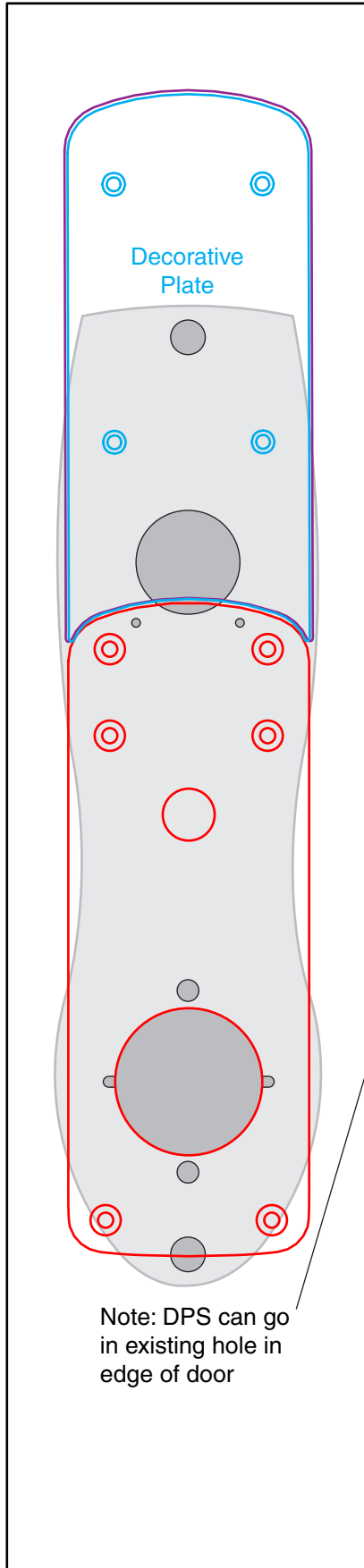

	Retrofitting From: Sargent Profile 10G77 (1 of 2)	
	To New Lock: Schlage AD-200-CY Schlage AD-250-CY Schlage AD-300-CY	
Decorative Plate Choices		
Surface Mounted Plates		
Outside <u>23760309</u>	Inside <u>23760309</u>	
 		
-----OR-----		
Thru-Bolted Plates		
Outside <u>23760291</u>	Inside <u>23760309</u>	
 		

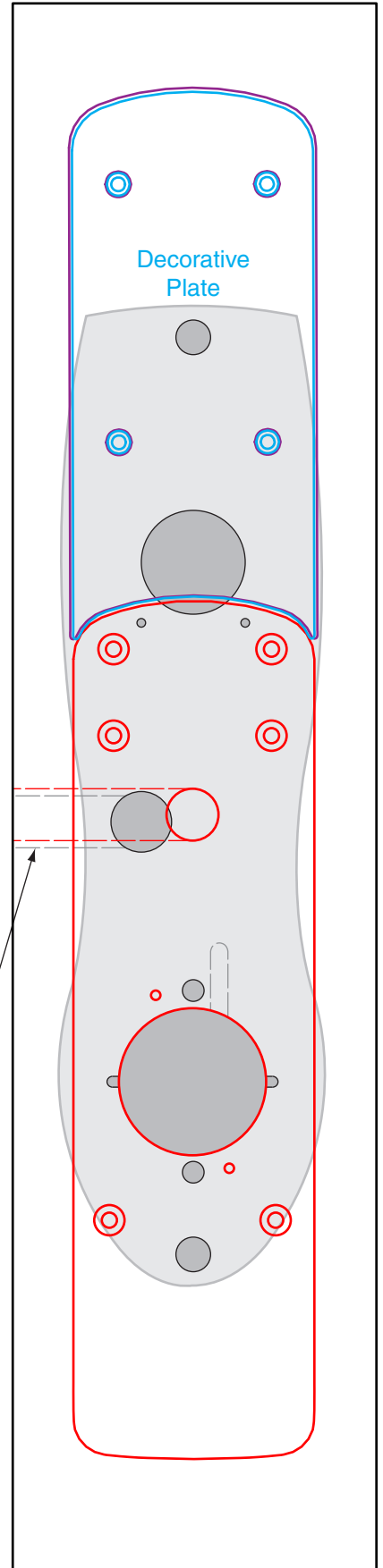

Outside Face of Door

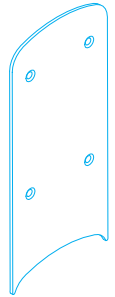
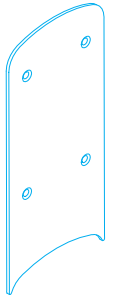

Inside Face of Door

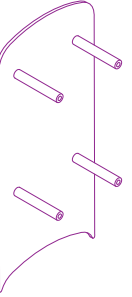
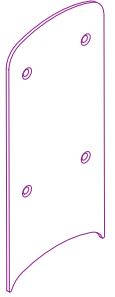
	Retrofitting From: Schlage CL5200-CM5200 (1 of 2)	
	To New Lock: Schlage AD-200-CY Schlage AD-250-CY Schlage AD-300-CY	
DECORATIVE PLATE CHOICES		
Surface Mounted Plates		
	Outside 23760309 	Inside 23760309 
-----OR-----		
Thru-Bolted Plates		
	Outside 23760291 	Inside 23760309 

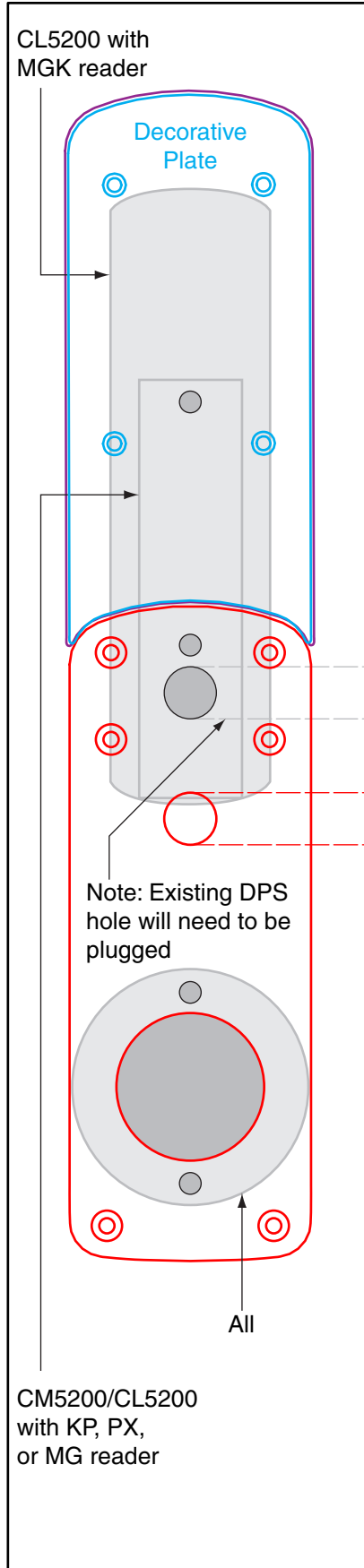

Outside Face of Door

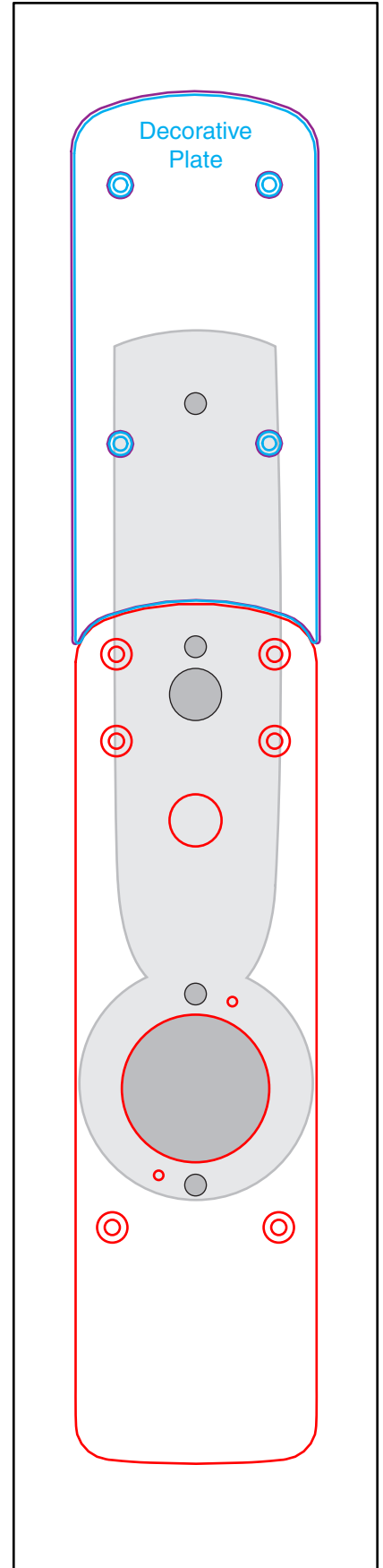

Inside Face of Door

 **Retrofitting From:**
Schlage CL5200-CM5200 (2 of 2)

 **To New Lock:**
Schlage AD-400-CY

DECORATIVE PLATE CHOICES

Surface Mounted Plates

Outside
23760309

Inside
23760267

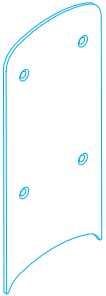

-----OR-----

Thru-Bolted Plates

Outside
23760291

Inside
23760317

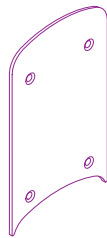
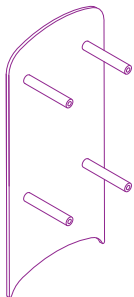

CL5200 with
MGK reader

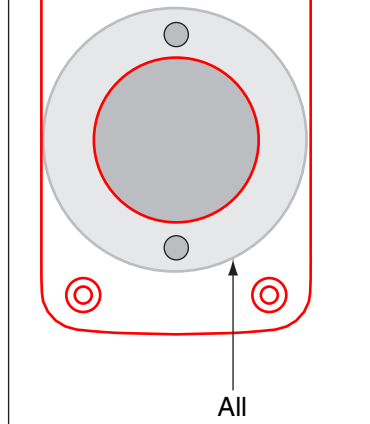
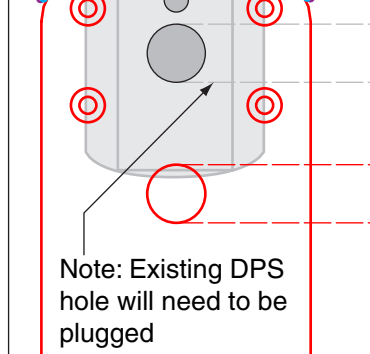
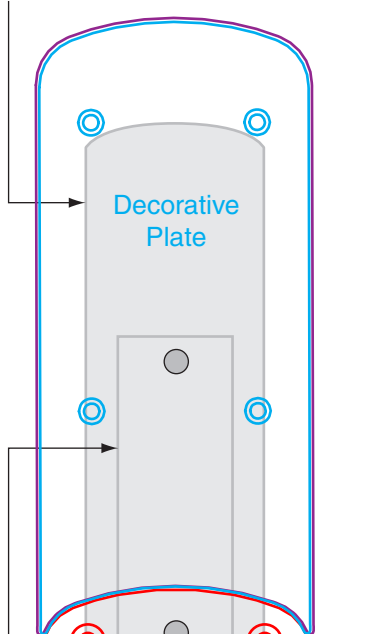





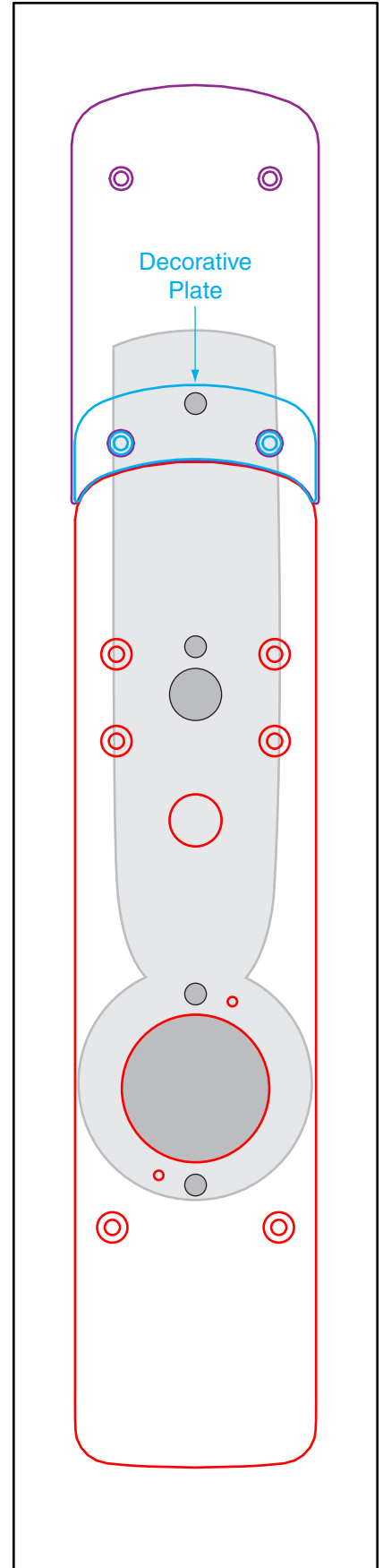



CM5200/CL5200
with KP, PX,
or MG reader

Outside Face of Door

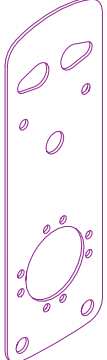

Inside Face of Door

	Retrofitting From: Schlage CM5100-HW (1 of 2)	
	To New Lock: Schlage AD-200-CY Schlage AD-250-CY Schlage AD-300-CY	
DECORATIVE PLATE CHOICES		
Surface Mounted Plates		
	Outside 23760267	Inside 23760267
		
----- OR -----		
	Under the Lock Plate Outside 23760259*	Surface Mounted Plate Inside 23760267
		

*A single under the lock plate will add 0.075" to the door thickness. AD Series Devices can be ordered for door thicknesses by increments of 0.125".

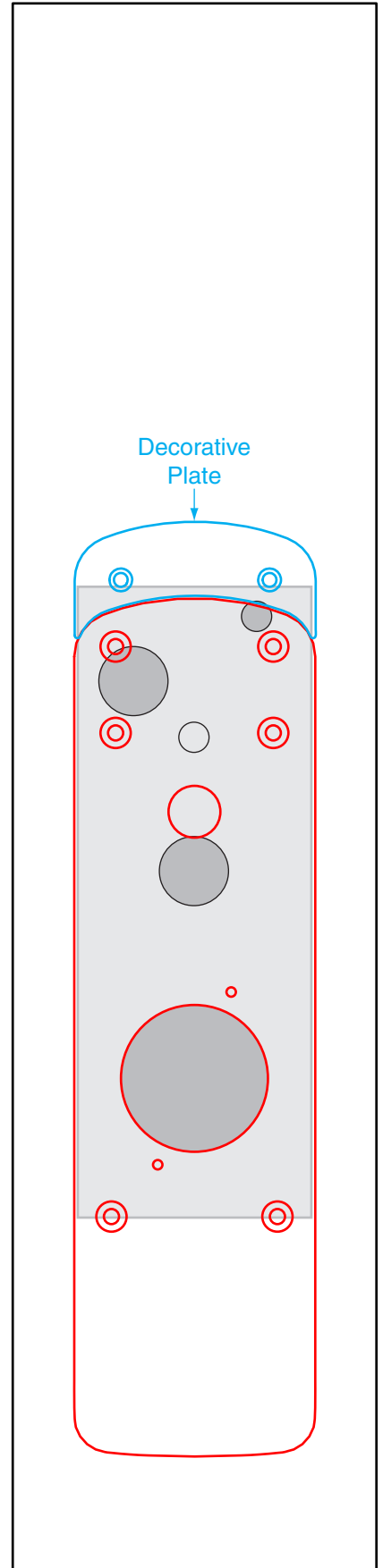
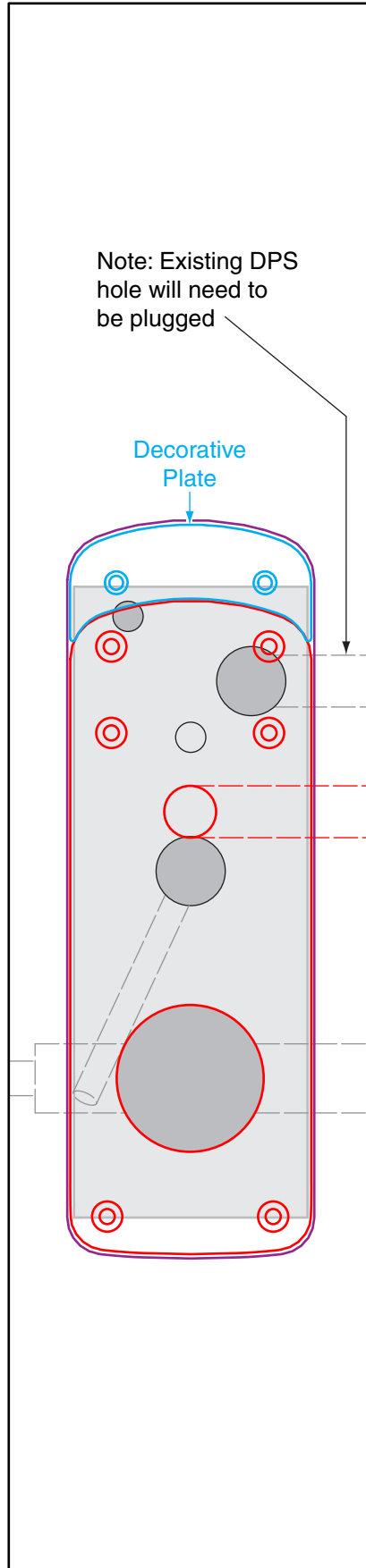

	Retrofitting From: Schlage CM5100-HW (2 of 2)
--	---

	To New Lock: Schlage AD-400-CY
--	--

DECORATIVE PLATE CHOICES

Surface Mounted Plates		
	Outside 23760267 	Inside n/a

-----OR-----

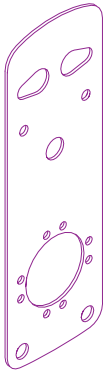
Under the Lock Plates		
	Outside 23760259* 	Inside n/a



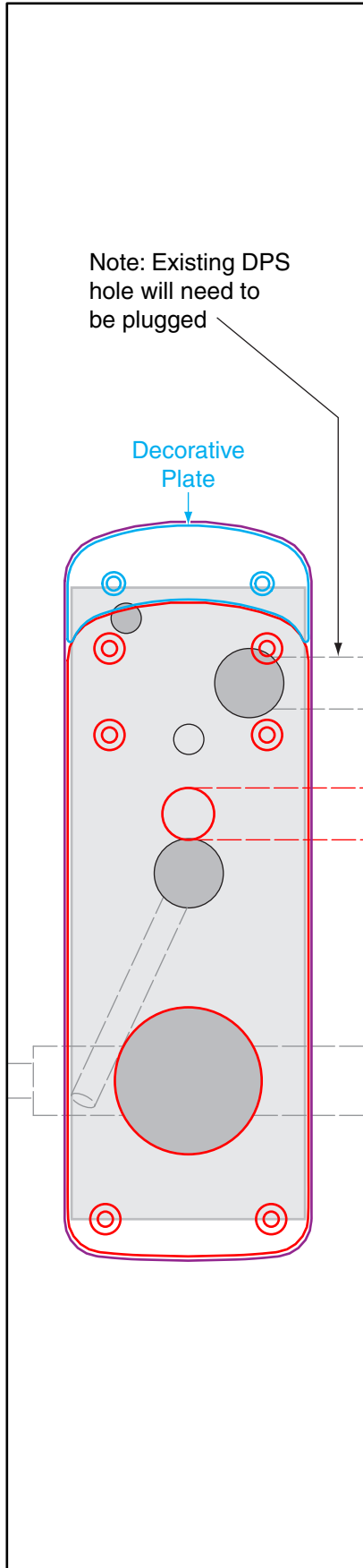



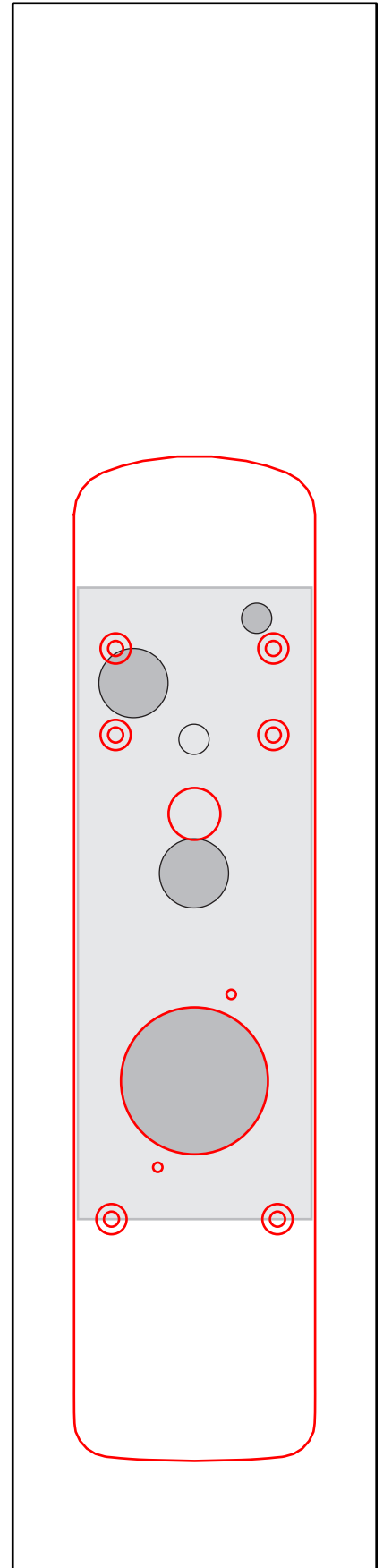

*A single under the lock plate will add 0.075" to the door thickness. AD Series Devices can be ordered for door thicknesses by increments of 0.125".



Outside Face of Door

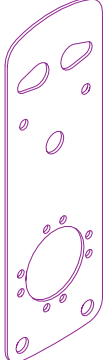

Inside Face of Door

	Retrofitting From: Schlage CM-CL-PRO-5100 (1 of 2)	
	To New Lock: Schlage AD-200-CY Schlage AD-250-CY Schlage AD-300-CY	
DECORATIVE PLATE CHOICES		
Surface Mounted Plates		
	Outside <u>23760267</u>	Inside <u>23760267</u>
		
----- OR -----		
	Under the Lock Plate Outside <u>23760259*</u>	Surface Mounted Plate Inside <u>23760267</u>
		

*A single under the lock plate will add 0.075" to the door thickness. AD Series Devices can be ordered for door thicknesses by increments of 0.125".

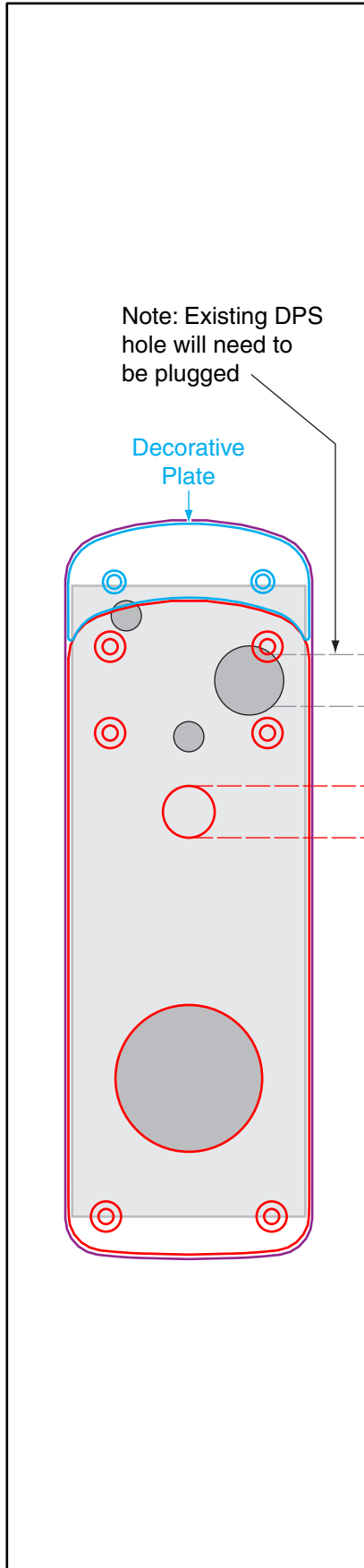

Outside Face of Door

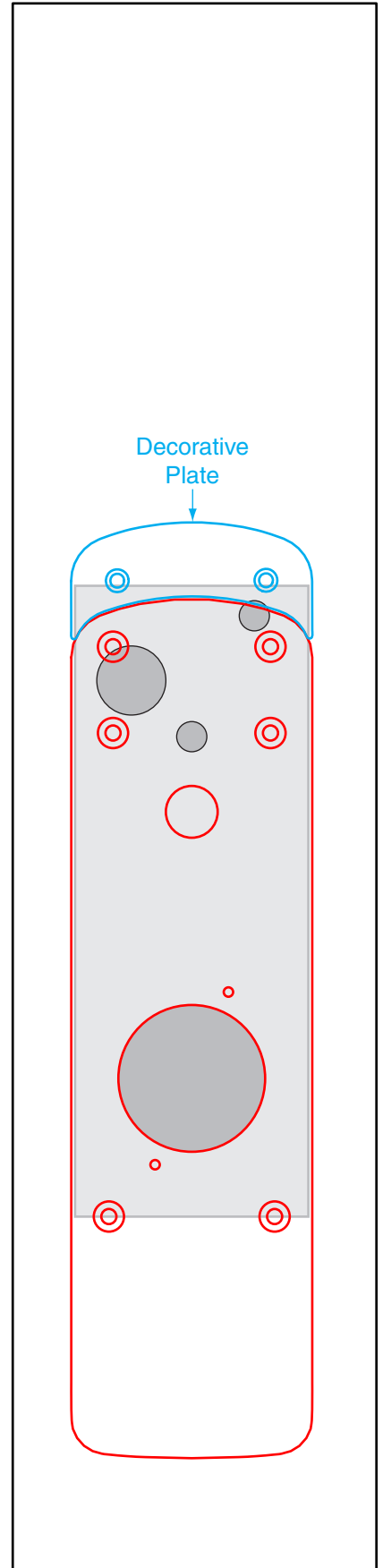



Inside Face of Door

	Retrofitting From: Schlage CM-CL-PRO-5100 (2 of 2)
---	--

	To New Lock: Schlage AD-400-CY
---	--

DECORATIVE PLATE CHOICES

Surface Mounted Plates

	Outside <u>23760267</u> 	Inside n/a
---	--	----------------------

-----OR-----

Under the Lock Plates

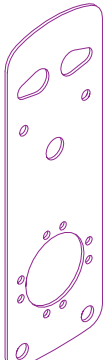
	Outside <u>23760259*</u> 	Inside n/a
--	--	----------------------

*A single under the lock plate will add 0.075" to the door thickness. AD Series Devices can be ordered for door thicknesses by increments of 0.125".

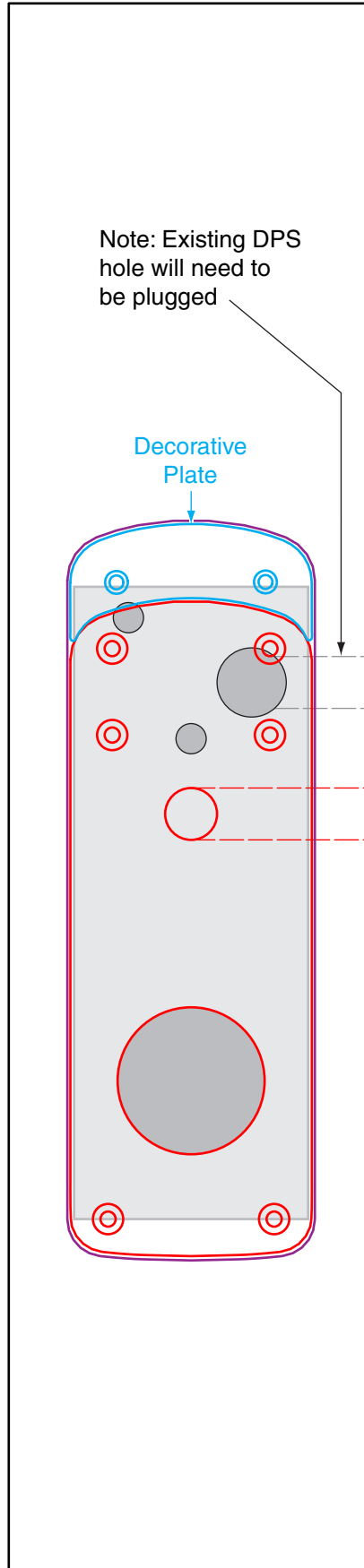

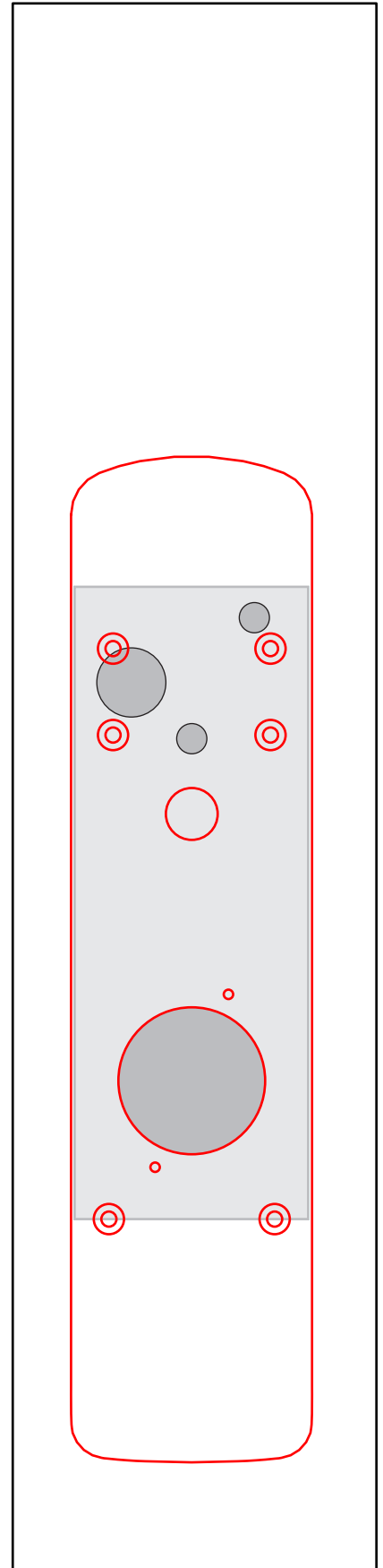

Outside Face of Door



Inside Face of Door

Schlage CO-100/200-CY

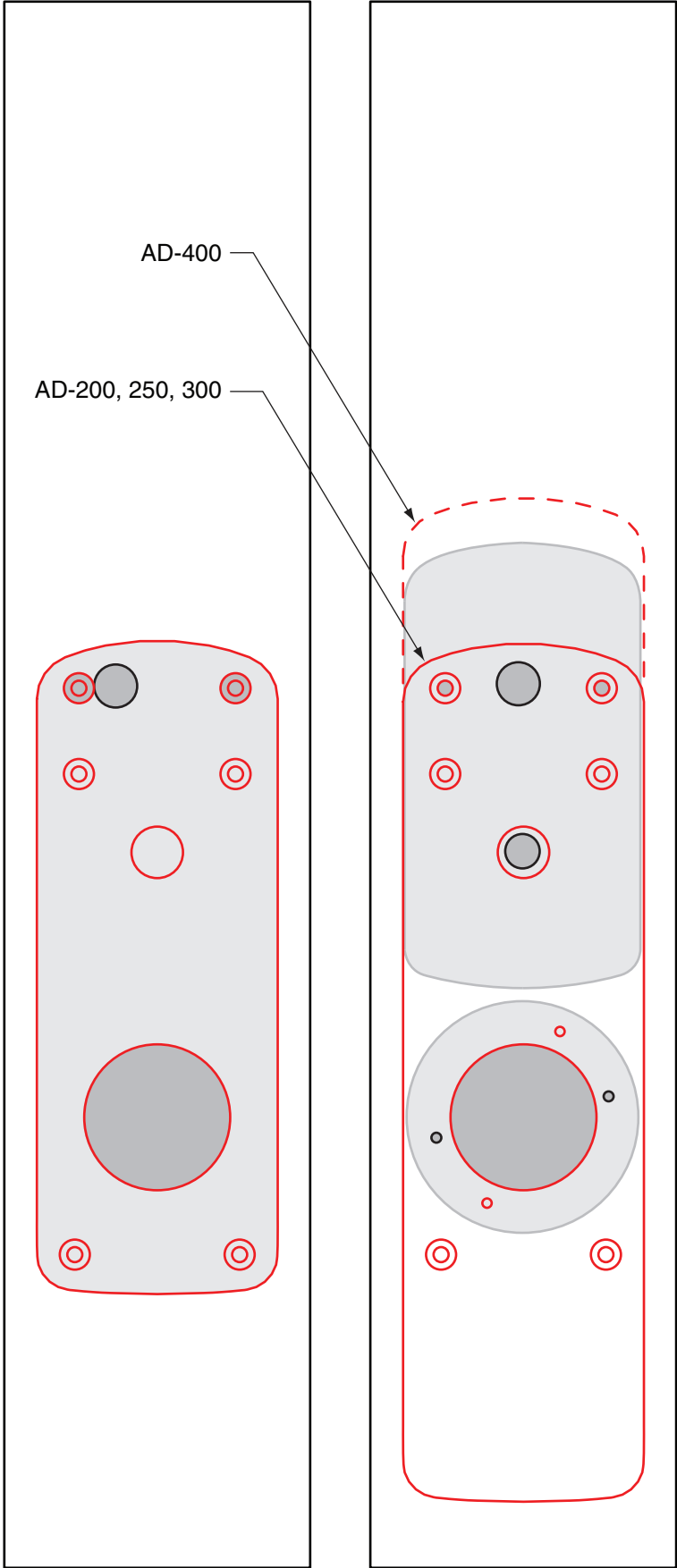

	Retrofitting From: Schlage CO-100/200-CY
	To New Lock: Schlage AD-200-CY Schlage AD-250-CY Schlage AD-300-CY Schlage AD-400-CY
	Decorative Plates Required: n/a



Outside Face of Door

Inside Face of Door

Schlage KC5100

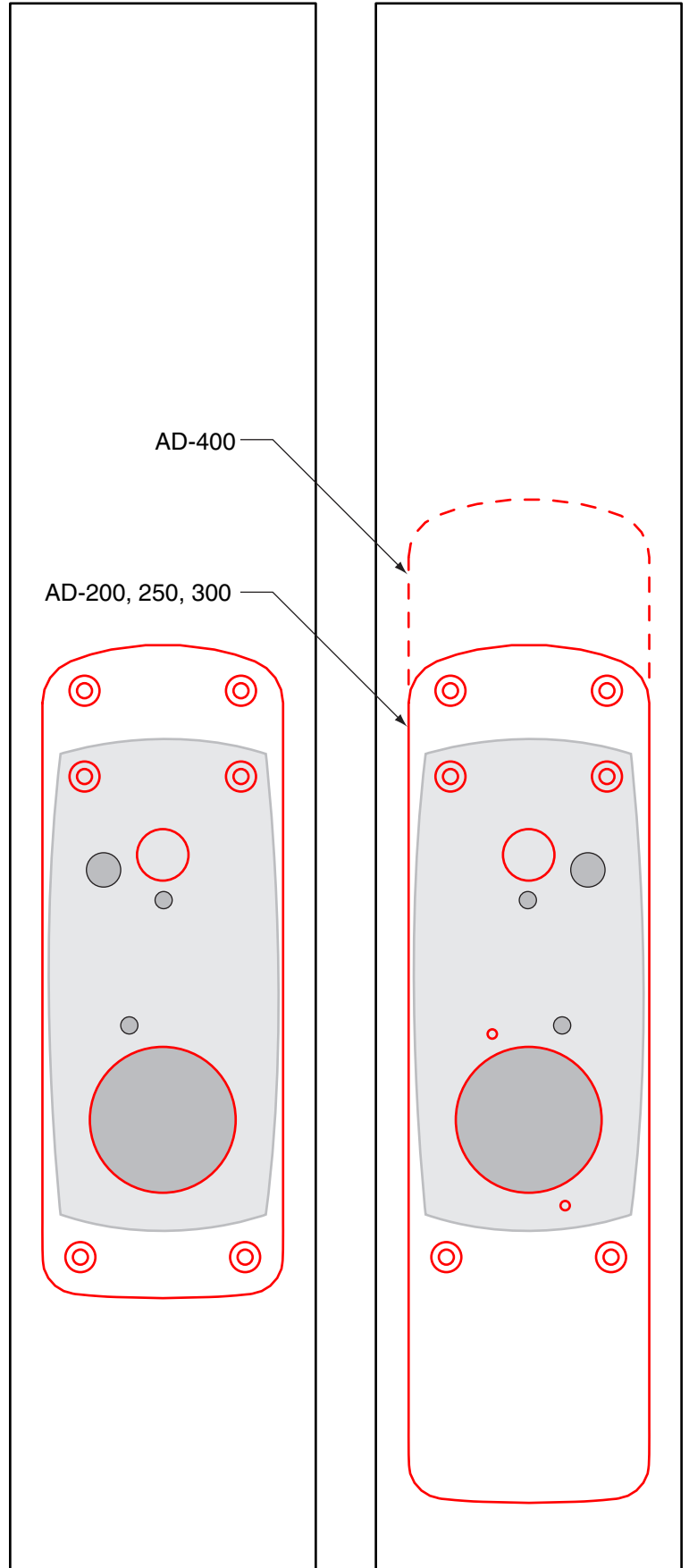

	Retrofitting From: Schlage KC5100
	To New Lock: Schlage AD-200-CY Schlage AD-250-CY Schlage AD-300-CY Schlage AD-400-CY
	Decorative Plates Required: n/a



Outside Face of Door

Inside Face of Door



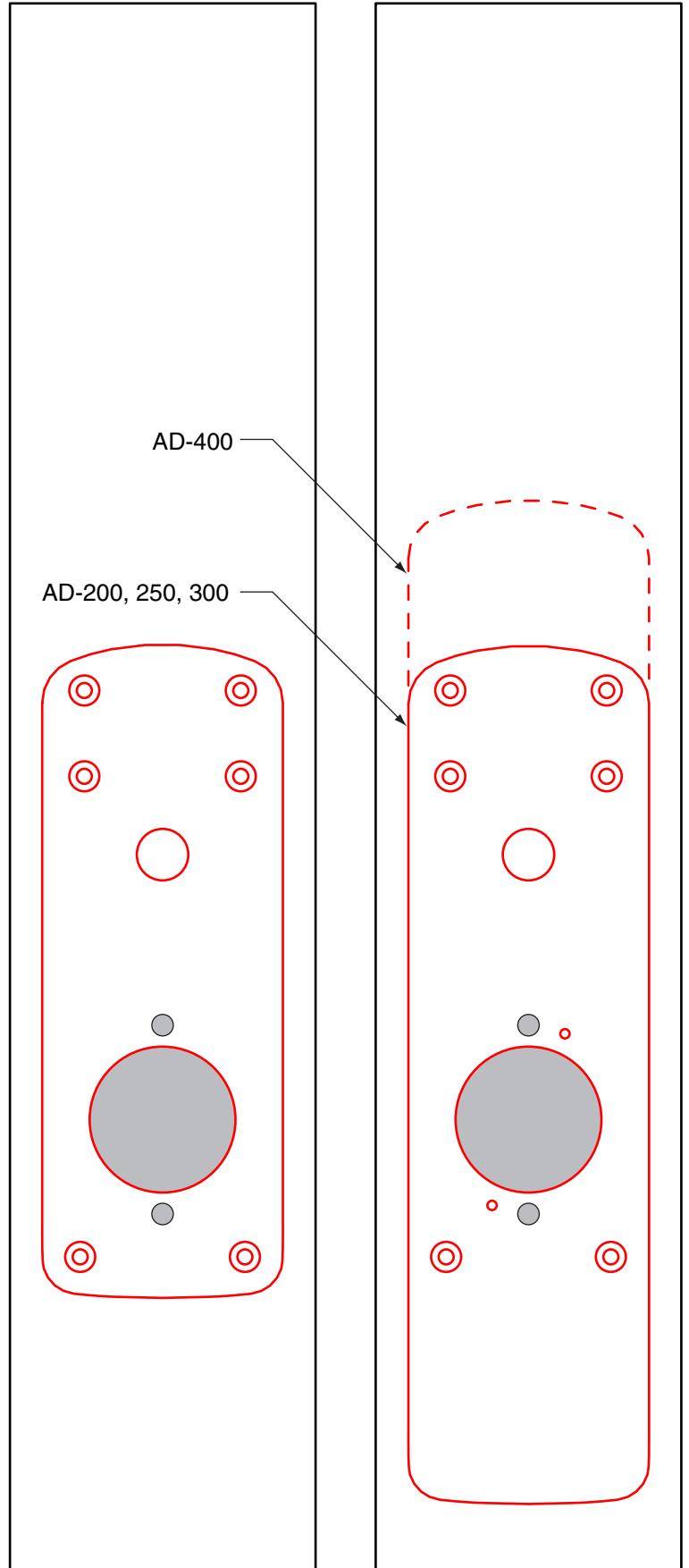

Schlage ND Series

	Retrofitting From: Schlage ND Series
	To New Lock: Schlage AD-200-CY Schlage AD-250-CY Schlage AD-300-CY Schlage AD-400-CY
	Decorative Plates Required: n/a





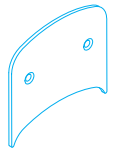
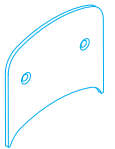

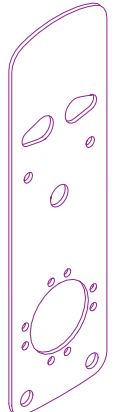
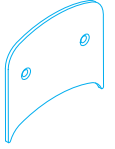

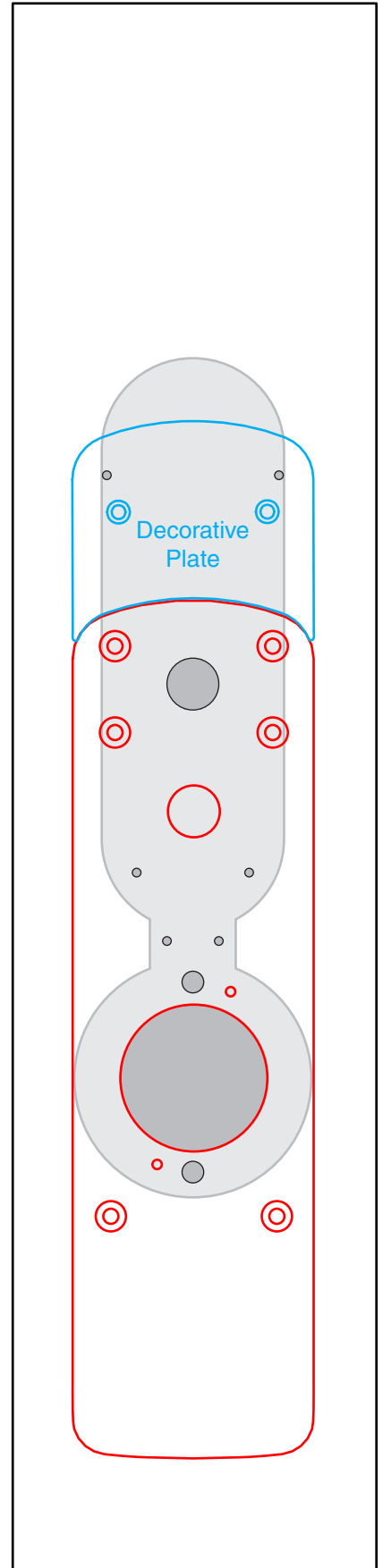
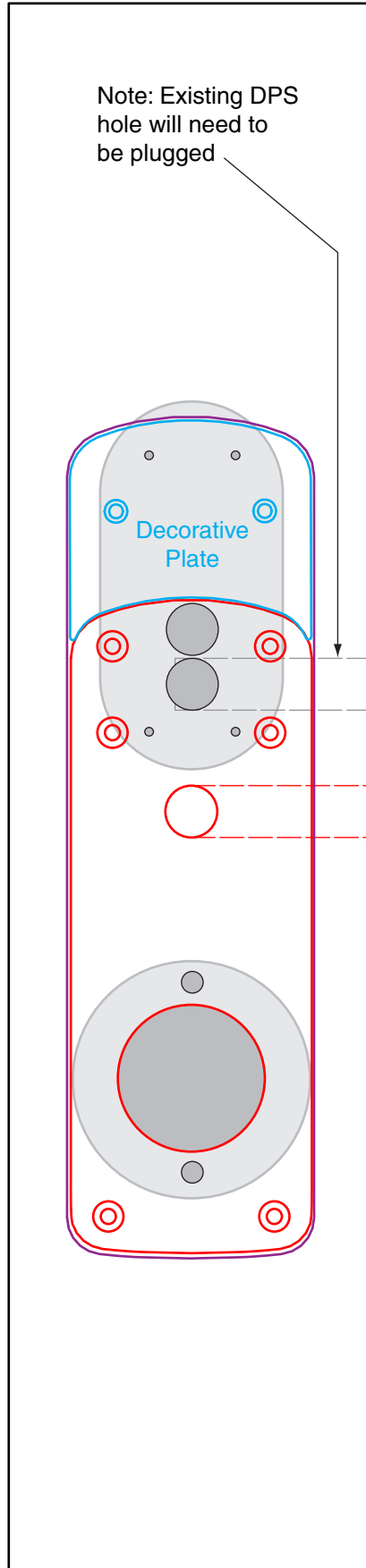

Outside Face of Door

Inside Face of Door

	Retrofitting From: Schlage WA5200 (1 of 2)	
	To New Lock: Schlage AD-200-CY Schlage AD-250-CY Schlage AD-300-CY	
Decorative Plate Choices		
Surface Mounted Plates		
	Outside <u>23760283</u>	Inside <u>23760283</u>
		
-----OR-----		
	Under the Lock Plate	Surface Mounted Plate
	Outside <u>23760275*</u>	Inside <u>23760283</u>
		

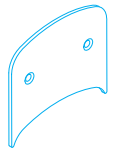
*A single under the lock plate will add 0.075" to the door thickness. AD Series Devices can be ordered for door thicknesses by increments of 0.125".

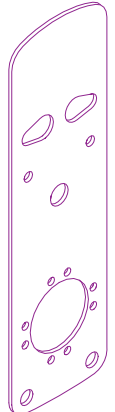

	Retrofitting From: Schlage WA5200 (2 of 2)	
	To New Lock: Schlage AD-400-CY	
Decorative Plate Choices		
Surface Mounted Plates		
	Outside <u>23760283</u>	Inside <u>23760267</u>
		
----- OR -----		
	Under the Lock Plate	Surface Mounted Plate
	Outside <u>23760275*</u>	Inside <u>23760267</u>
		



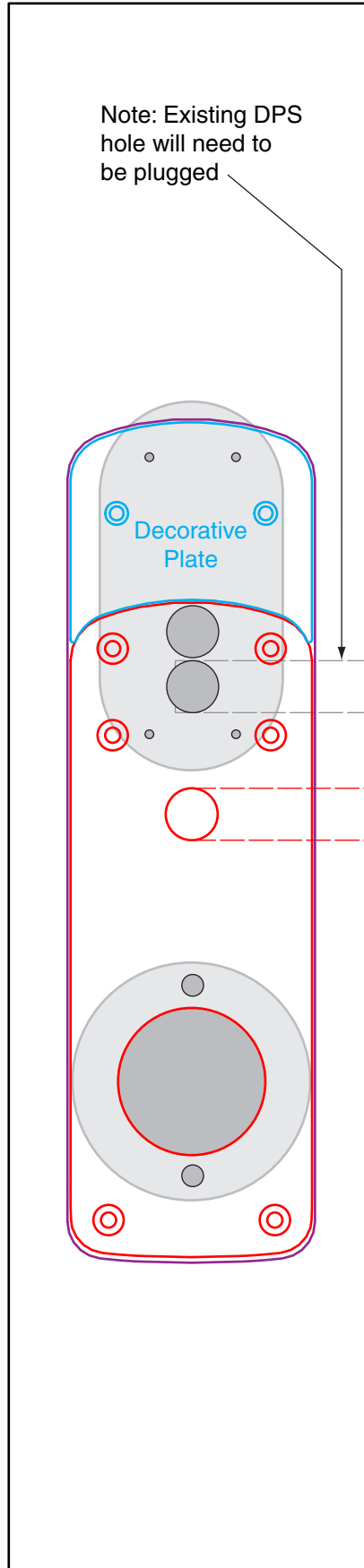



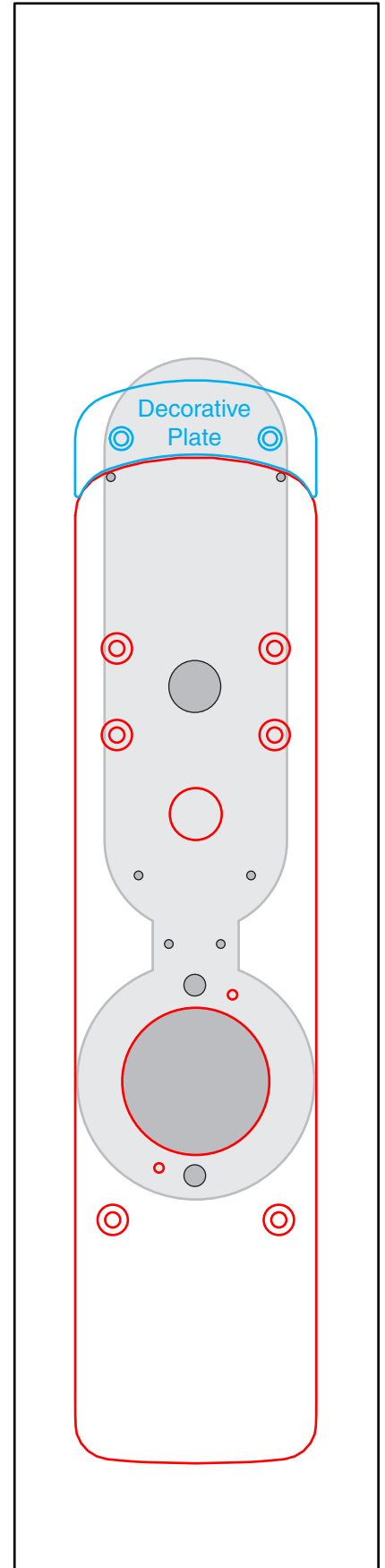

*A single under the lock plate will add 0.075" to the door thickness. AD Series Devices can be ordered for door thicknesses by increments of 0.125".



Outside Face of Door

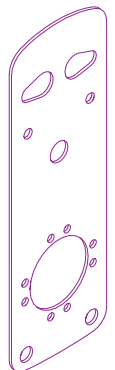

Inside Face of Door

	Retrofitting From: VIP 5100 (1 of 2)	
	To New Lock: Schlage AD-200-CY Schlage AD-250-CY Schlage AD-300-CY	
Decorative Plate Choices		
Surface Mounted Plates		
	Outside <u>23760267</u>	Inside <u>23760267</u>
		
----- OR -----		
	Under the Lock Plate	Surface Mounted Plate
	Outside <u>23760259*</u>	Inside <u>23760267</u>
		



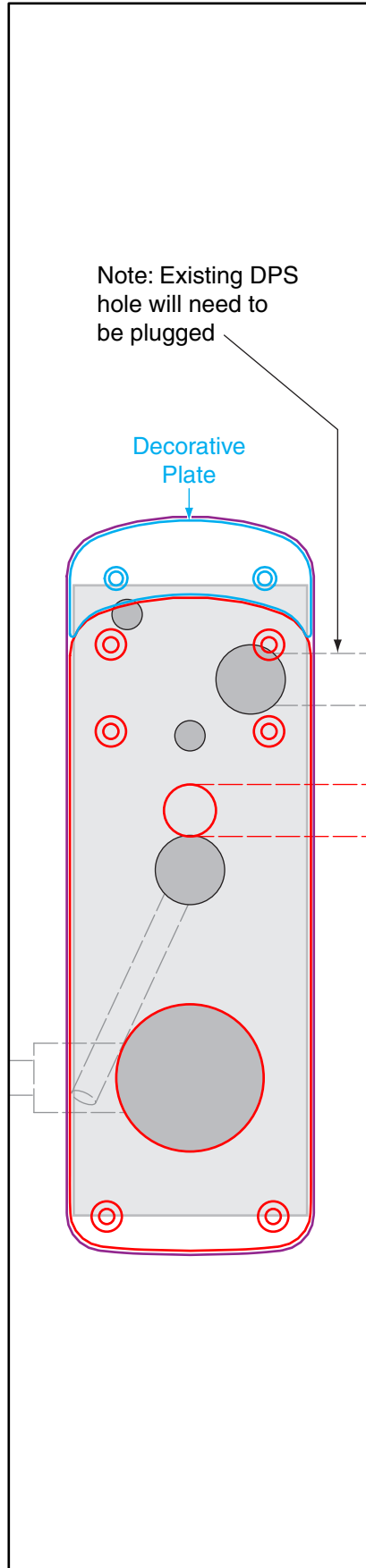

*A single under the lock plate will add 0.075" to the door thickness. AD Series Devices can be ordered for door thicknesses by increments of 0.125".

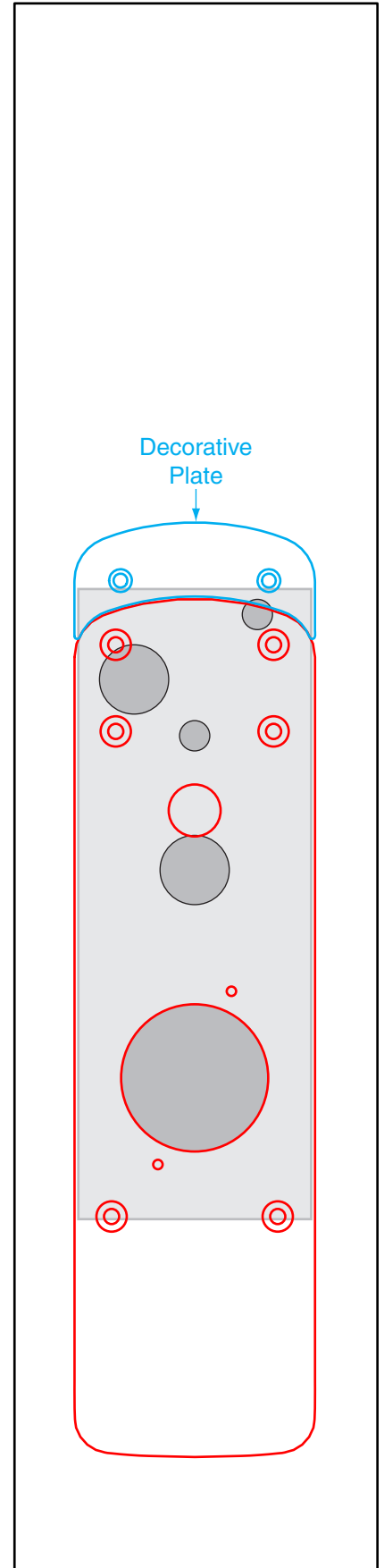

Outside Face of Door

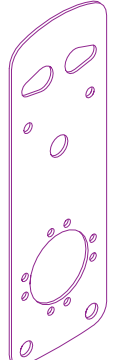

Inside Face of Door

	Retrofitting From: VIP 5100 (2 of 2)	
	To New Lock: Schlage AD-400-CY	
Decorative Plate Choices		
Surface Mounted Plates		
	Outside <u>23760267</u> 	Inside n/a
	----- OR -----	
Under the Lock Plates		
	Outside <u>23760259*</u> 	Inside n/a



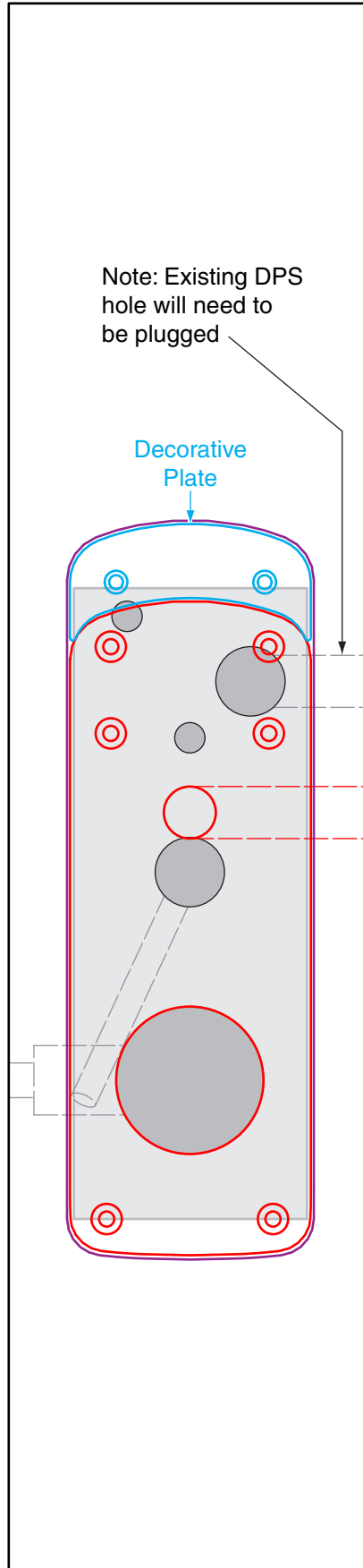

*A single under the lock plate will add 0.075" to the door thickness. AD Series Devices can be ordered for door thicknesses by increments of 0.125".

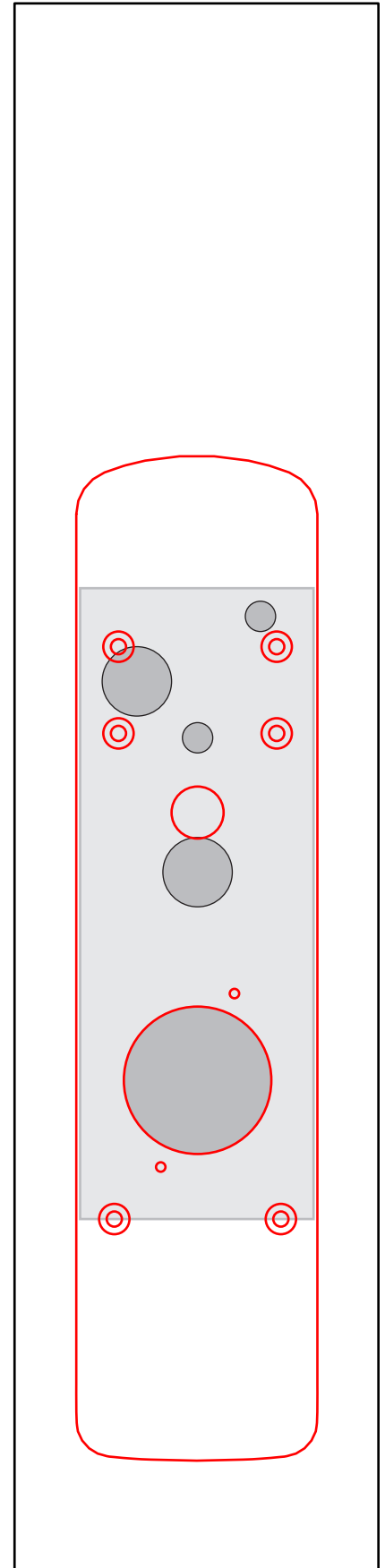

Outside Face of Door

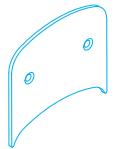
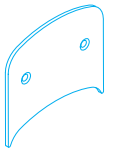

Inside Face of Door

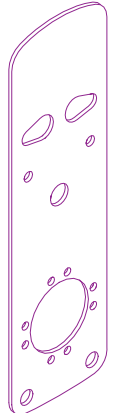
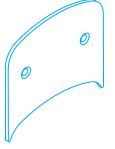
	Retrofitting From: Alarm Lock DL3500 (1 of 2)	
	To New Lock: Schlage AD-200-MS/MD Schlage AD-250-MS/MD Schlage AD-300-MS/MD	
Decorative Plate Choices		
Surface Mounted Plates		
	Outside <u>23760283</u>	Inside <u>23760283</u>
		
-----OR-----		
	Under the Lock Plate Outside <u>23760275*</u>	Surface Mounted Plate Inside <u>23760283</u>
		



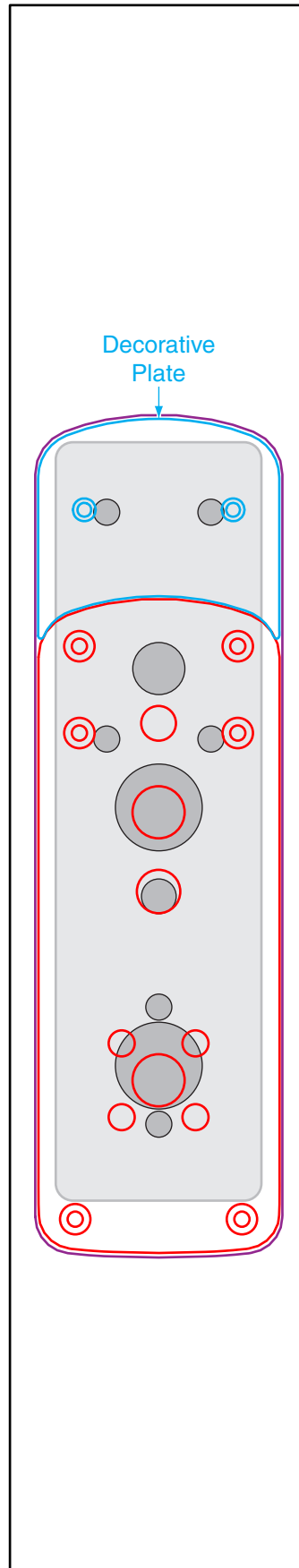

*A single under the lock plate will add 0.075" to the door thickness. AD Series Devices can be ordered for door thicknesses by increments of 0.125".

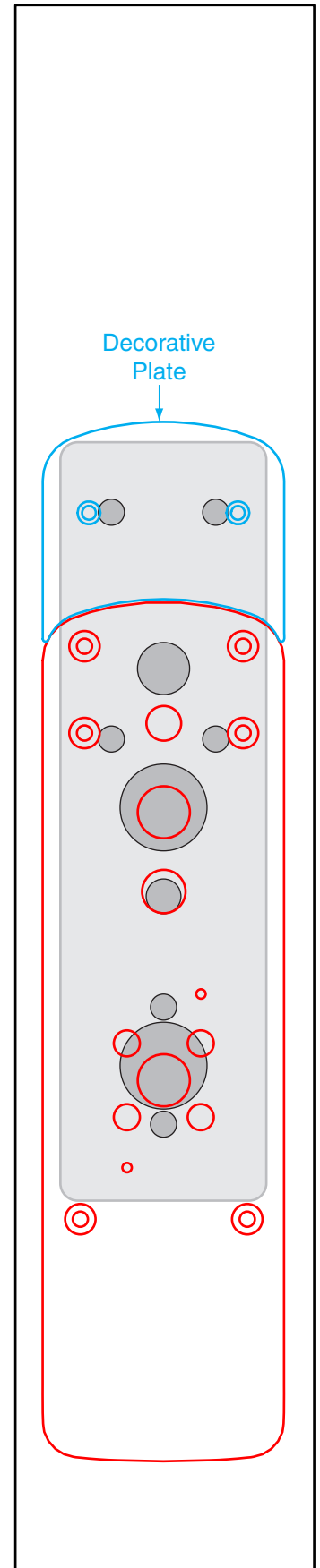

Outside Face of Door

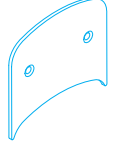

Inside Face of Door

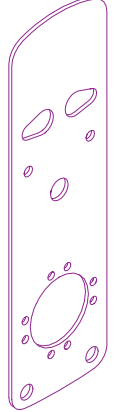
	Retrofitting From: Alarm Lock DL3500 (2 of 2)	
	To New Lock: Schlage AD-400-MS/MD	
Decorative Plate Choices		
Surface Mounted Plates		
	Outside <u>23760283</u>	Inside n/a
		
-----OR-----		
Under the Lock Plates		
	Outside <u>23760275*</u>	Inside n/a
		

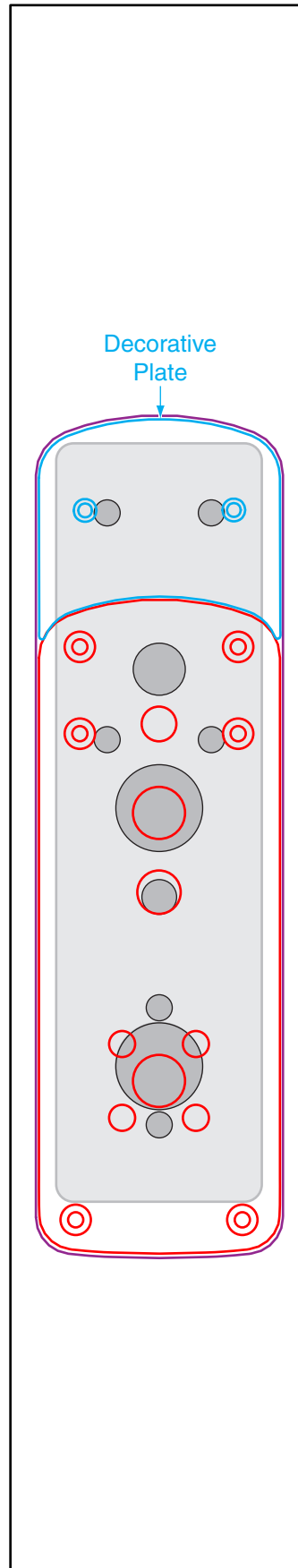

*A single under the lock plate will add 0.075" to the door thickness. AD Series Devices can be ordered for door thicknesses by increments of 0.125".

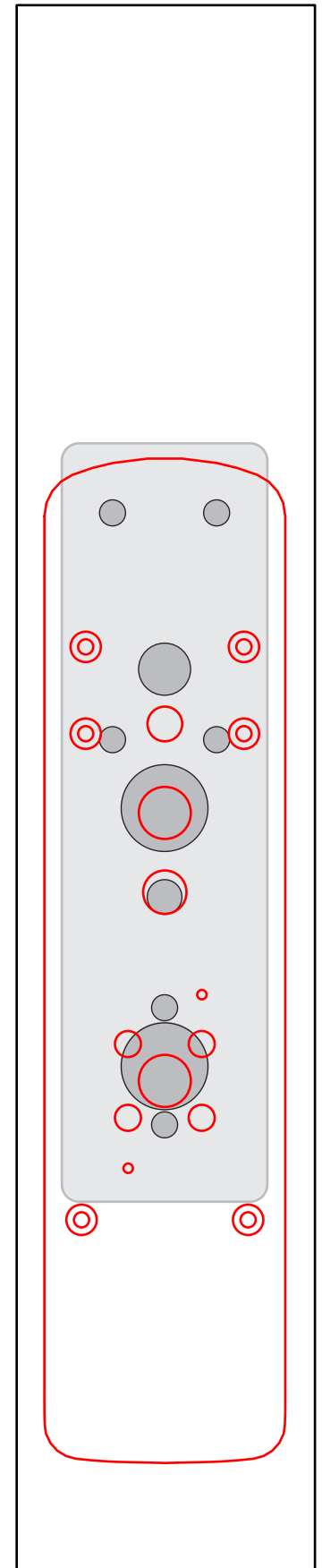

Outside Face of Door



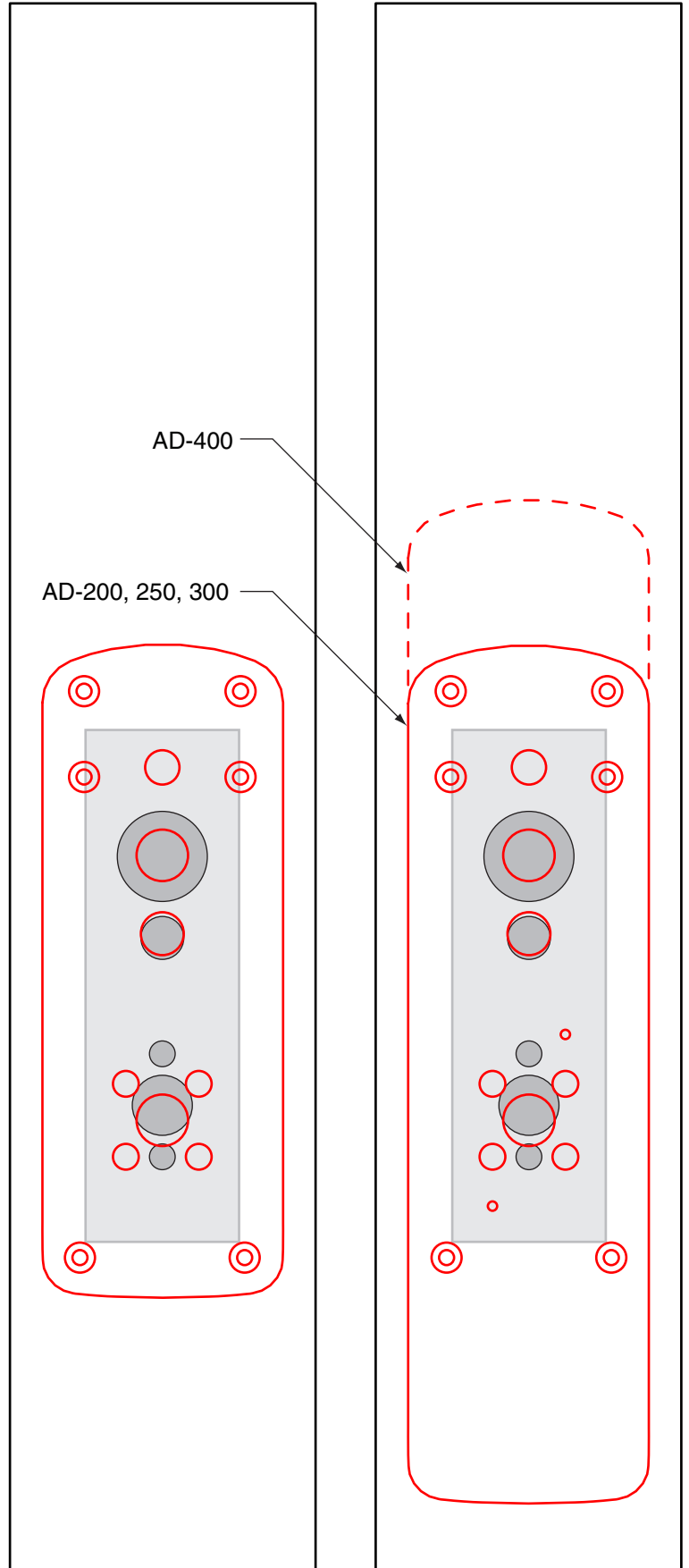

Inside Face of Door

	Retrofitting From: Corbin ML2000
	To New Lock: Schlage AD-200-MS/MD Schlage AD-250-MS/MD Schlage AD-300-MS/MD Schlage AD-400-MS/MD
	Decorative Plates Required: n/a



Outside Face of Door

Inside Face of Door

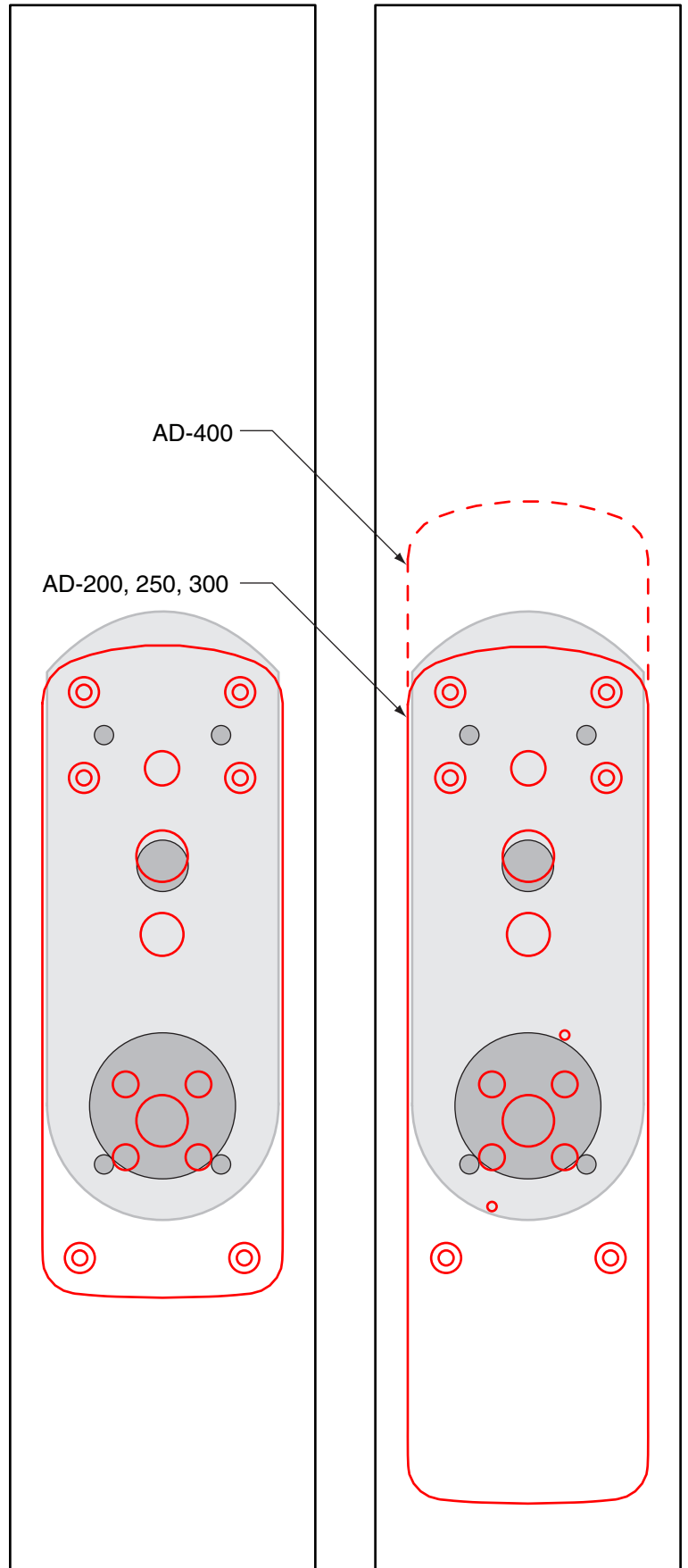

	Retrofitting From: Kaba E5700
	To New Lock: Schlage AD-200-MS/MD Schlage AD-250-MS/MD Schlage AD-300-MS/MD Schlage AD-400-MS/MD
	Decorative Plates Required: n/a



Outside Face of Door

Inside Face of Door



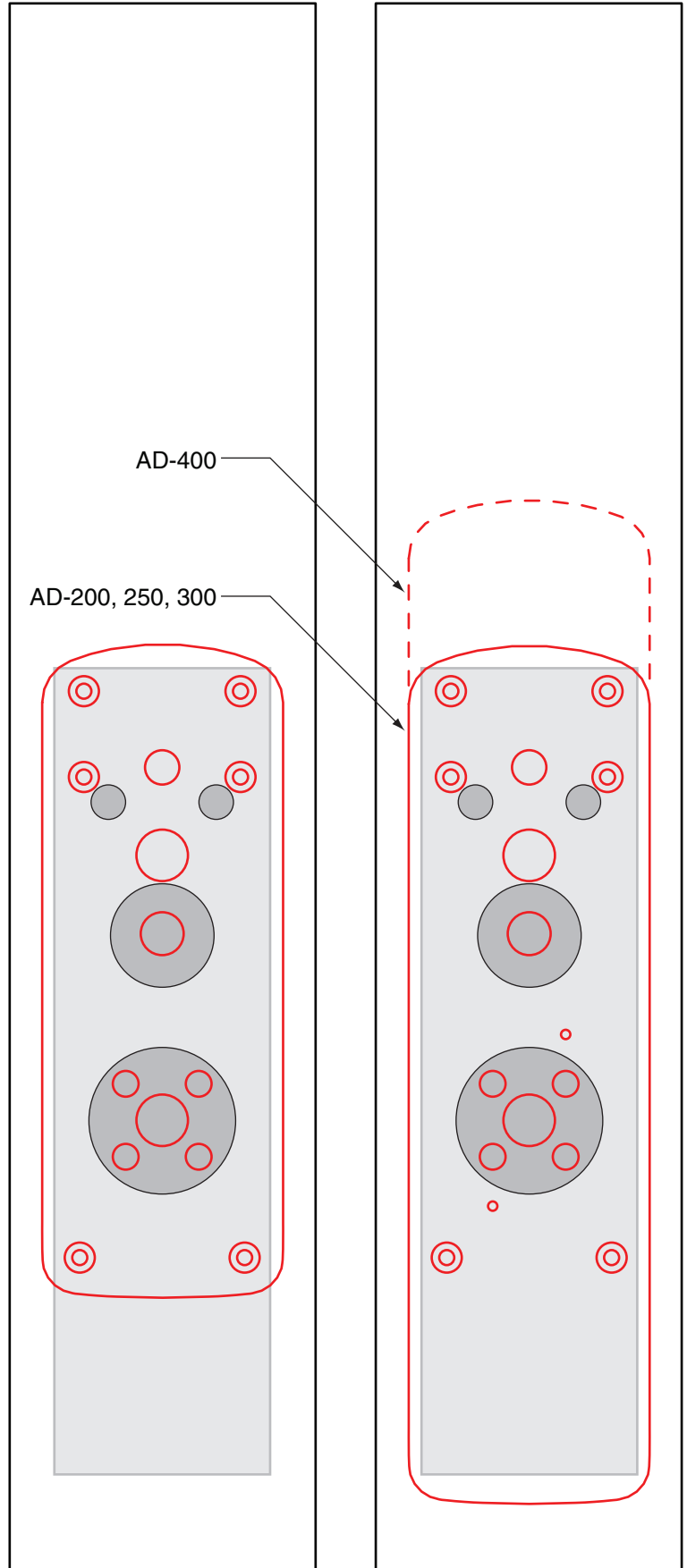

Onity-HT

	Retrofitting From: Onity-HT
	To New Lock: Schlage AD-200-MS/MD Schlage AD-250-MS/MD Schlage AD-300-MS/MD Schlage AD-400-MS/MD
	Decorative Plates Required: n/a



Outside Face of Door

Inside Face of Door

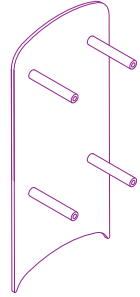
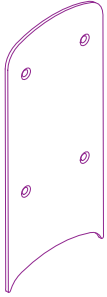

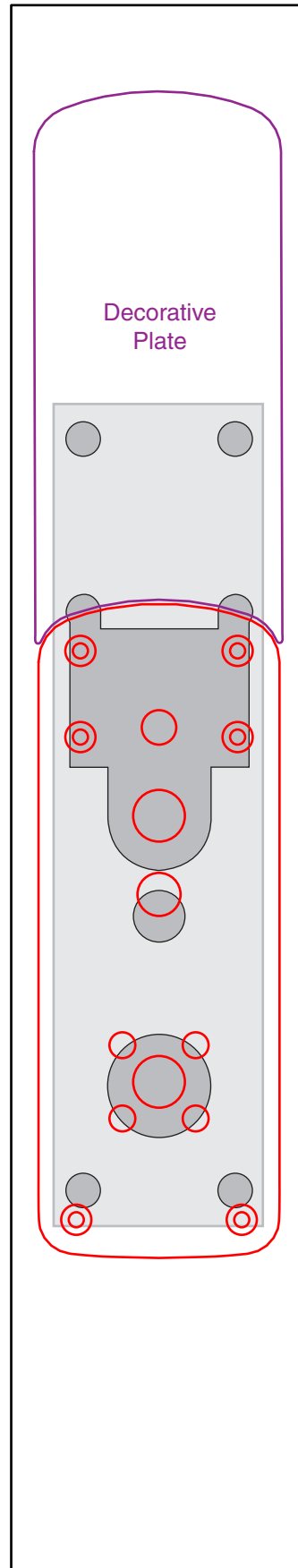

	Retrofitting From: Persona 4000R / 5000R (1 of 2)	
	To New Lock: Schlage AD-200-MS/MD Schlage AD-250-MS/MD Schlage AD-300-MS/MD	
Decorative Plate Choices		
	Surface Mounted Plates	
	Outside n/a	Inside n/a
----- OR -----		
	Thru-Bolted Plates	
	Outside <u>23760291</u> 	Inside <u>23760309</u> 

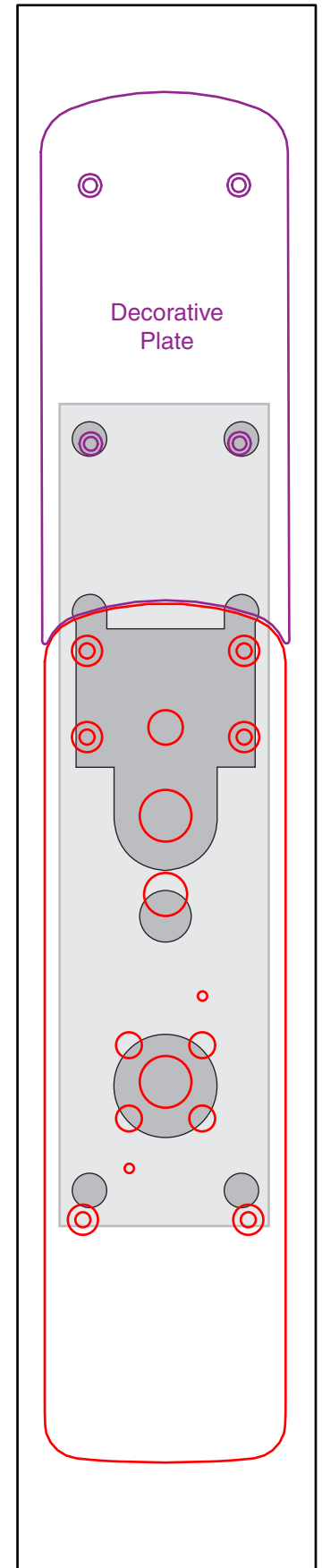

Outside Face of Door

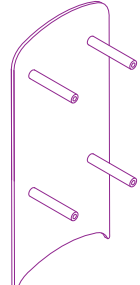
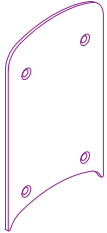

Inside Face of Door

	Retrofitting From: Persona 4000R / 5000R (2 of 2)	
	To New Lock: Schlage AD-400-MS/MD	
Decorative Plate Choices		
Surface Mounted Plates		
	Outside n/a	Inside n/a
----- OR -----		
Thru-Bolted Plates		
	Outside <u>23760291</u>	Inside <u>23760317</u>
		

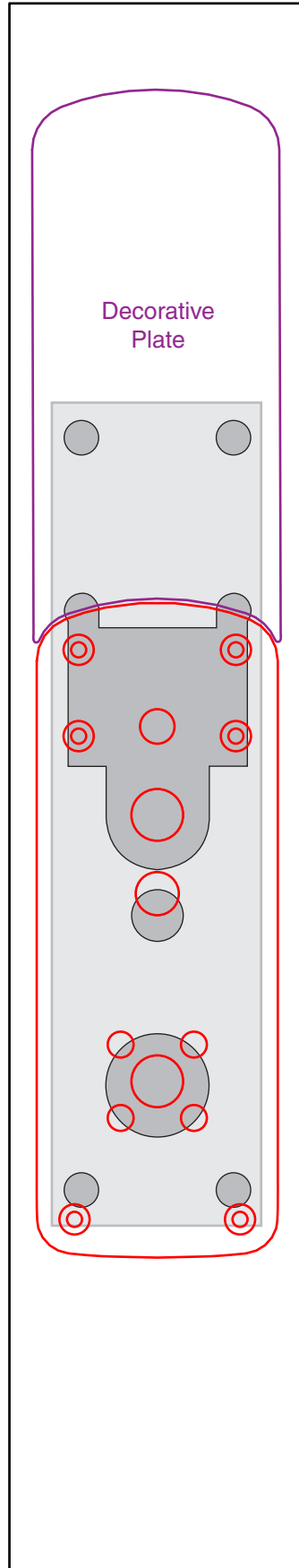

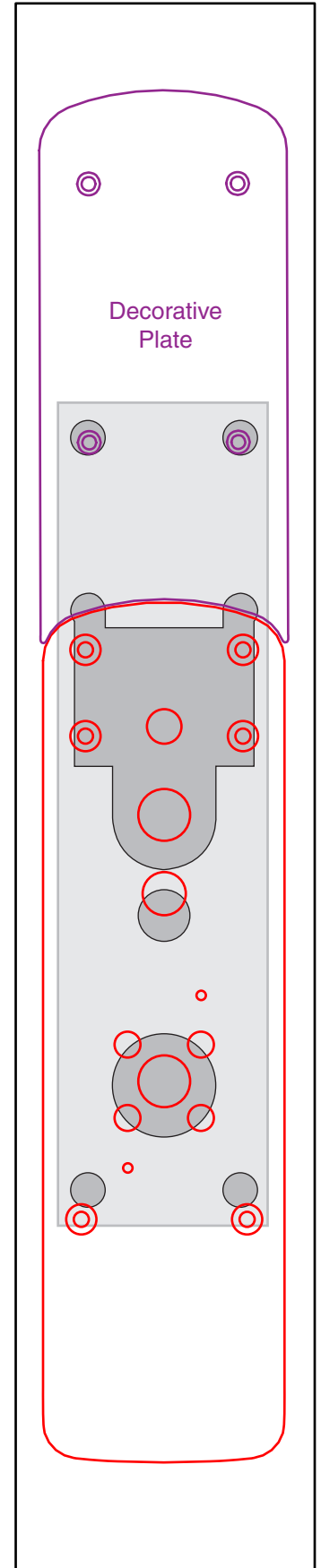

Outside Face of Door





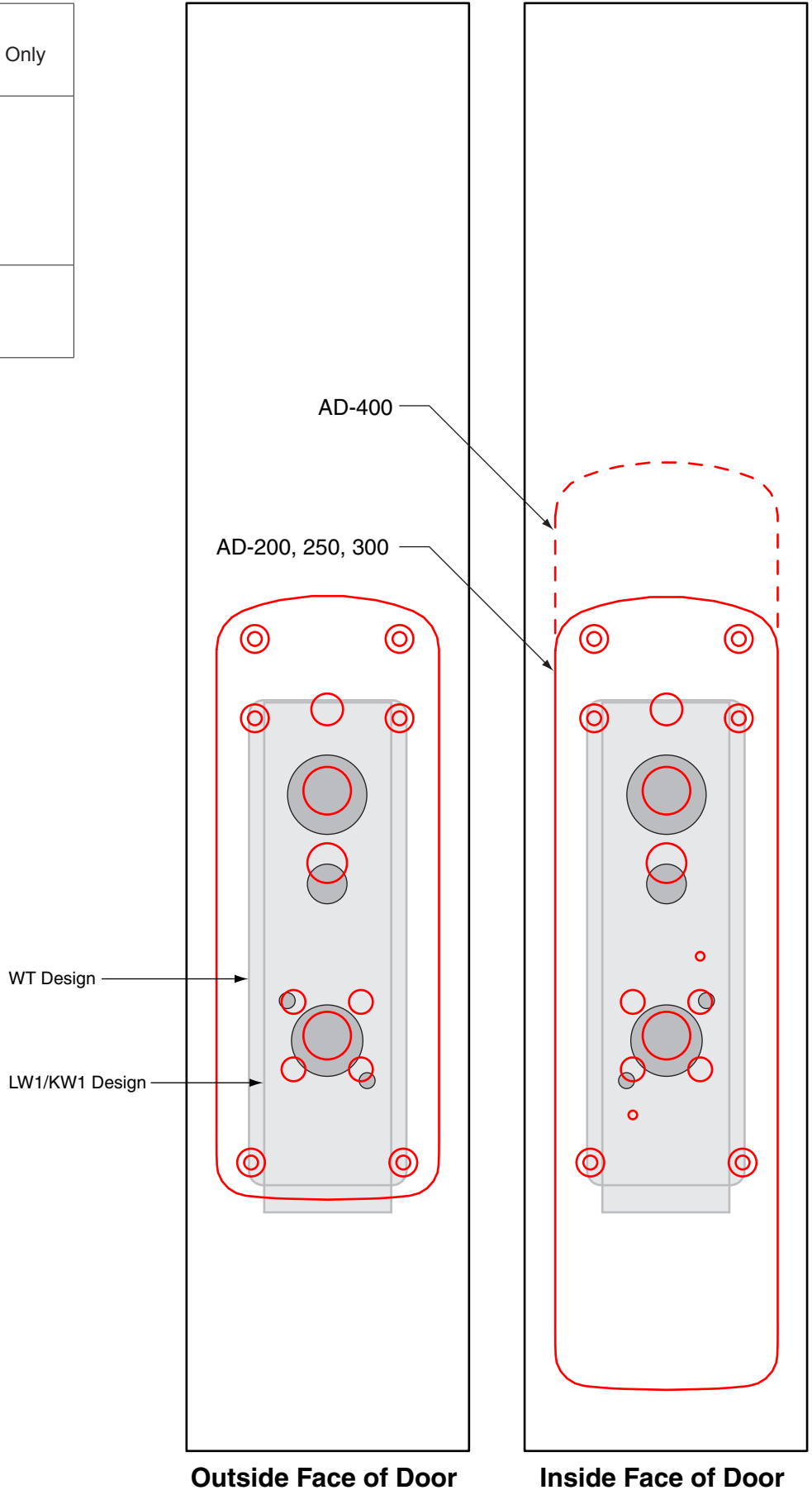

Inside Face of Door

Sargent 7900 Series Lock Body Only

	Retrofitting From: Sargent 7900 Series Lock Body Only
	To New Lock: Schlage AD-200-MS/MD Schlage AD-250-MS/MD Schlage AD-300-MS/MD Schlage AD-400-MS/MD
	Decorative Plates Required: n/a

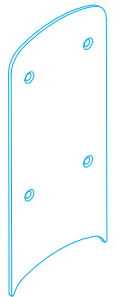
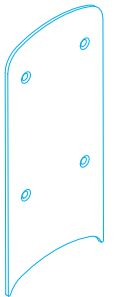

Sargent Profile Series Mortise (1 of 2)

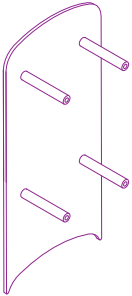
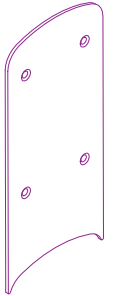
	Retrofitting From: Sargent Profile Series Mortise (1 of 2)	
	To New Lock: Schlage AD-200-MS/MD Schlage AD-250-MS/MD Schlage AD-300-MS/MD	
Decorative Plate Choices		
Surface Mounted Plates		
	Outside <u>23760309</u>	Inside <u>23760309</u>
		
-----OR-----		
Thru-Bolted Plates		
	Outside <u>23760291</u>	Inside <u>23760309</u>
		

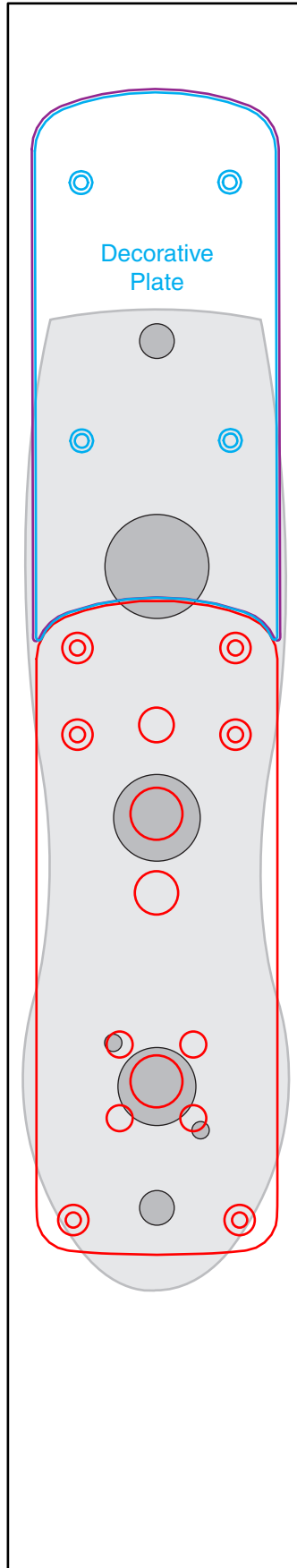



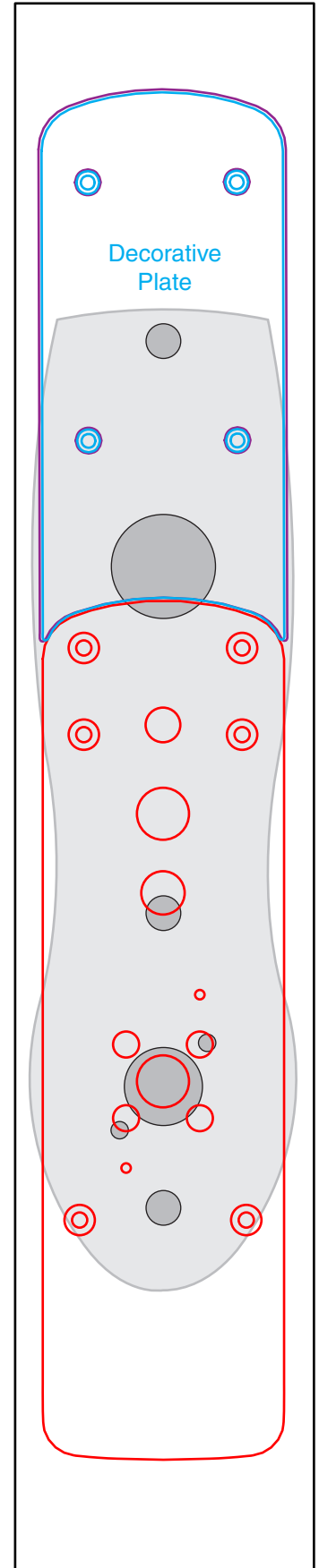

Outside Face of Door

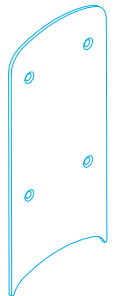
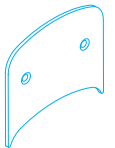

Inside Face of Door

Sargent Profile Series Mortise (2 of 2)

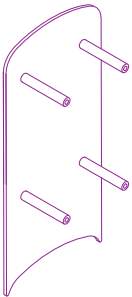
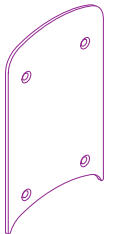

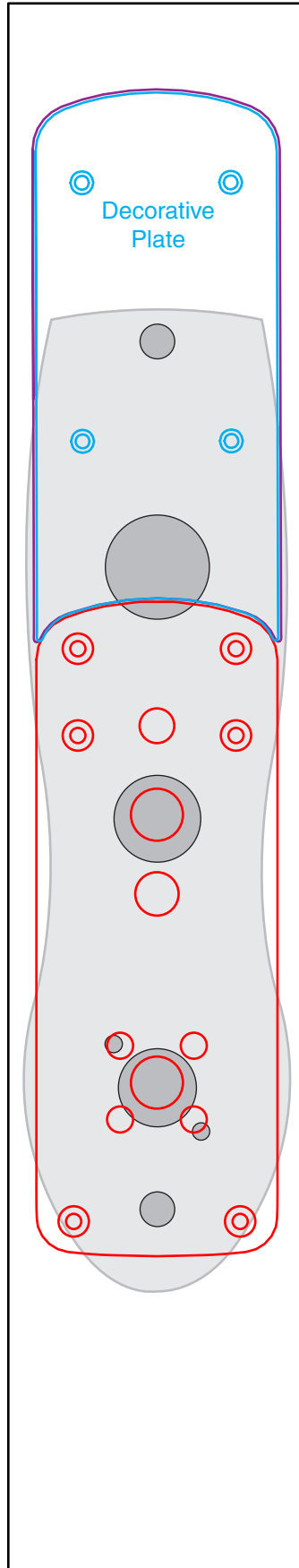

	Retrofitting From: Sargent Profile Series Mortise (2 of 2)
	To New Lock: Schlage AD-400-MS/MD
Decorative Plate Choices	
Surface Mounted Plates	
Outside <u>23760309</u>	Inside <u>23760283</u>
 	
-----OR-----	
Thru-Bolted Plates	
Outside <u>23760291</u>	Inside <u>23760317</u>
 	

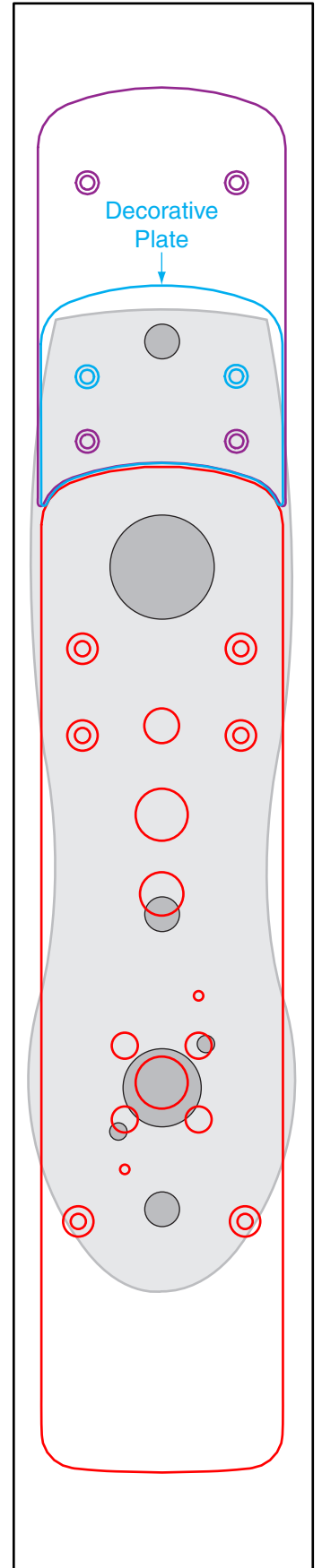

Outside Face of Door

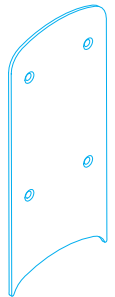
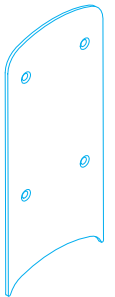

Inside Face of Door

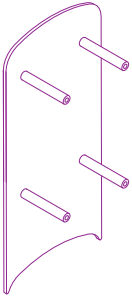
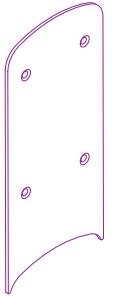

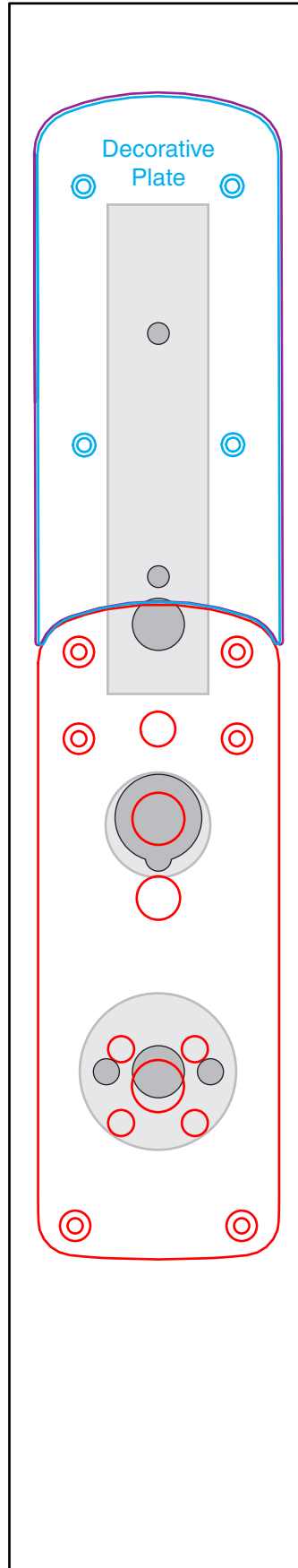

	Retrofitting From: Schlage CM5600 (1 of 2)	
	To New Lock: Schlage AD-200-MS/MD Schlage AD-250-MS/MD Schlage AD-300-MS/MD	
Decorative Plate Choices		
Surface Mounted Plates		
	Outside <u>23760309</u>	Inside <u>23760309</u>
		
-----OR-----		
Thru-Bolted Plates		
	Outside <u>23760291</u>	Inside <u>23760309</u>
		

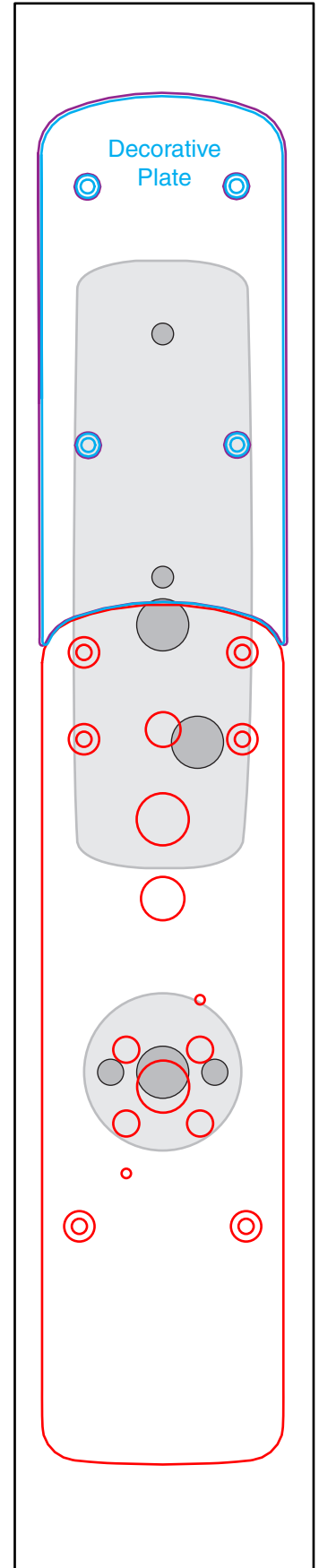

Outside Face of Door

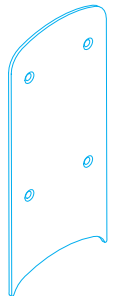
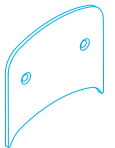

Inside Face of Door

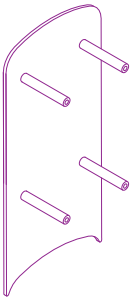
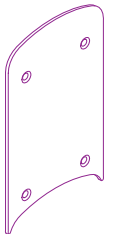

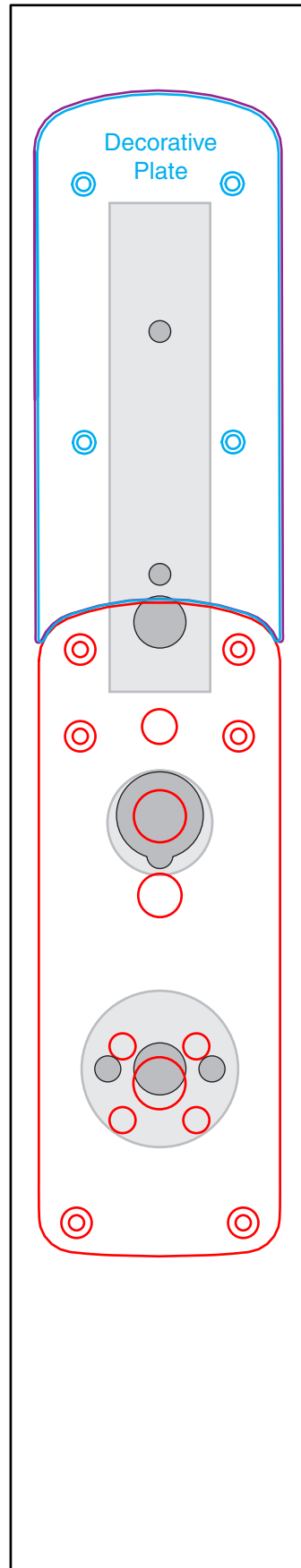



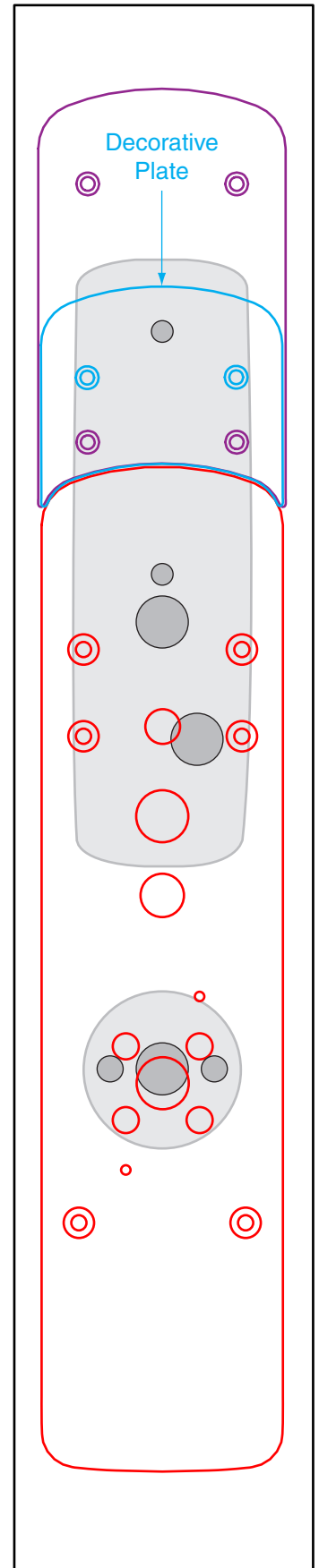

	Retrofitting From: Schlage CM5600 (2 of 2)	
	To New Lock: Schlage AD-400-MS/MD	
Decorative Plate Choices		
Surface Mounted Plates		
Outside <u>23760309</u>	Inside <u>23760283</u>	
 		
-----OR-----		
Thru-Bolted Plates		
Outside <u>23760291</u>	Inside <u>23760317</u>	
 		



Outside Face of Door

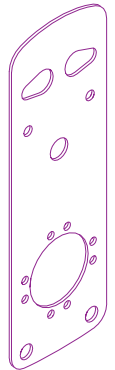

Inside Face of Door

	Retrofitting From: Schlage CM-CL-PRO-5500 (1 of 2)	
	To New Lock: Schlage AD-200-MS/MD Schlage AD-250-MS/MD Schlage AD-300-MS/MD	
Decorative Plate Choices		
	Surface Mounted Plates	
	Outside <u>23760267</u> 	Inside <u>23760267</u> 
----- OR -----		
	Under the Lock Plate	Surface Mounted Plate
	Outside <u>23760259*</u> 	Inside <u>23760267</u> 



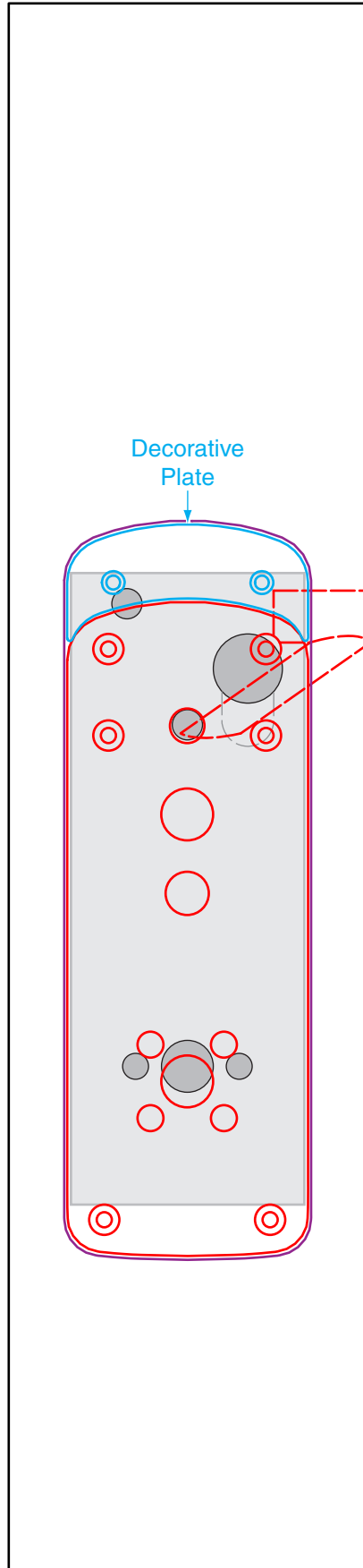

*A single under the lock plate will add 0.075" to the door thickness. AD Series Devices can be ordered for door thicknesses by increments of 0.125".

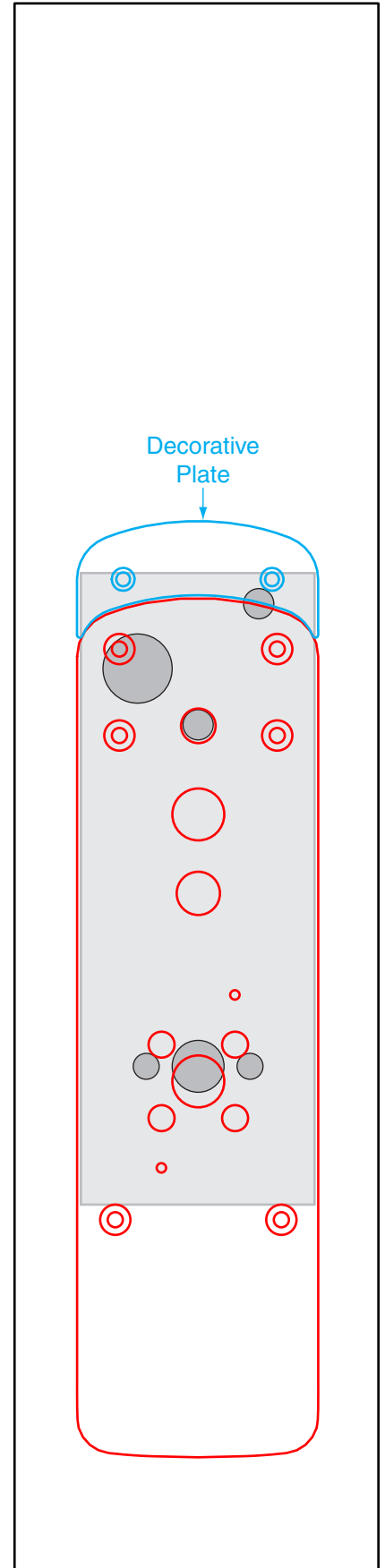

Outside Face of Door

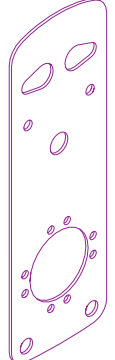

Inside Face of Door

	Retrofitting From: Schlage CM-CL-PRO-5500 (2 of 2)	
	To New Lock: Schlage AD-400-MS/MD	
Decorative Plate Choices		
Surface Mounted Plates		
	Outside <u>23760267</u>	Inside n/a
		
----- OR -----		
Under the Lock Plates		
	Outside <u>23760259*</u>	Inside n/a
		

*A single under the lock plate will add 0.075" to the door thickness. AD Series Devices can be ordered for door thicknesses by increments of 0.125".

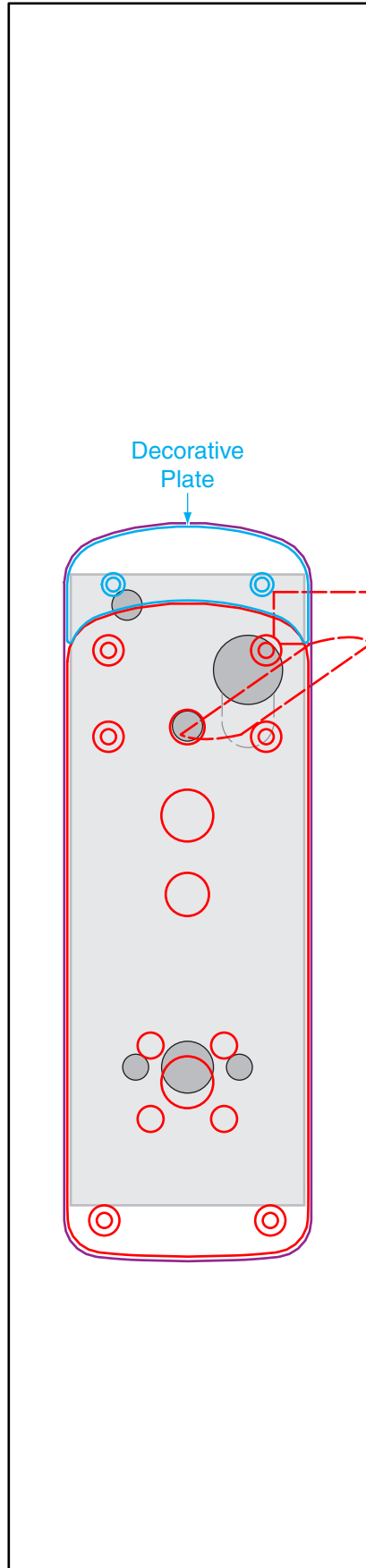

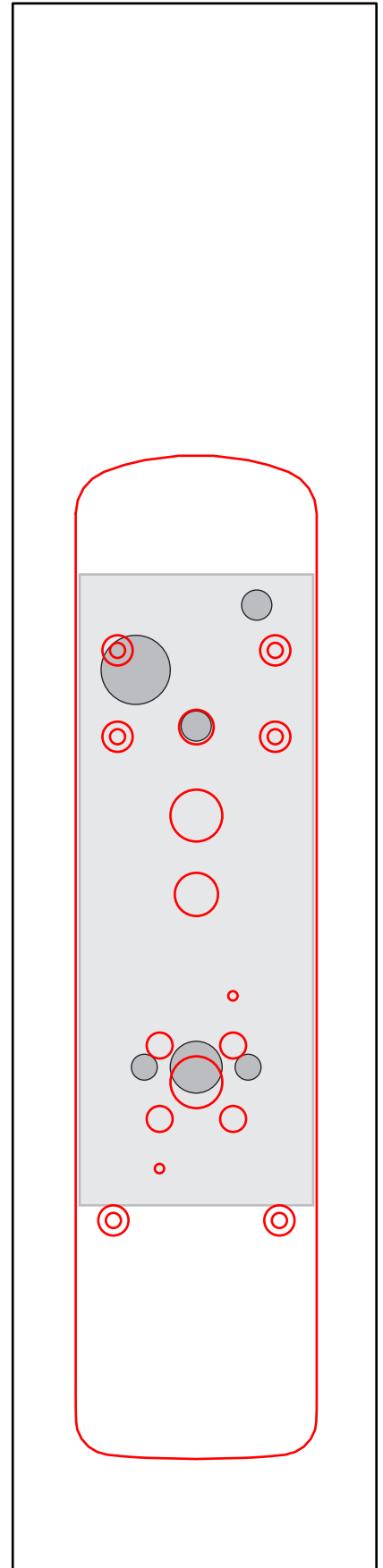

Outside Face of Door



Inside Face of Door

Schlage CO-100/200-MS/MD

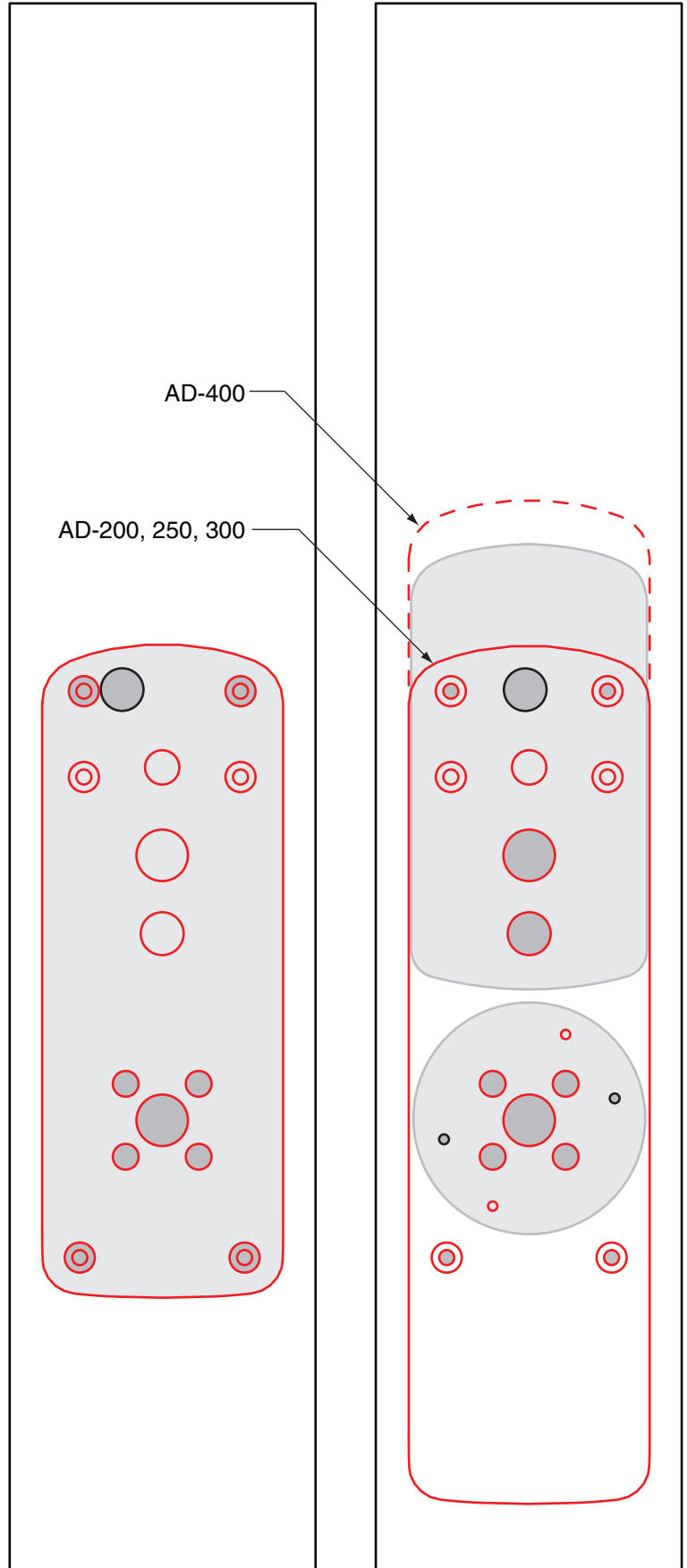

	Retrofitting From: Schlage CO-100/200-MS/MD
	To New Lock: Schlage AD-200-MS/MD Schlage AD-250-MS/MD Schlage AD-300-MS/MD Schlage AD-400-MS/MD
	Decorative Plates Required: n/a



Outside Face of Door

Inside Face of Door

Schlage KC5500

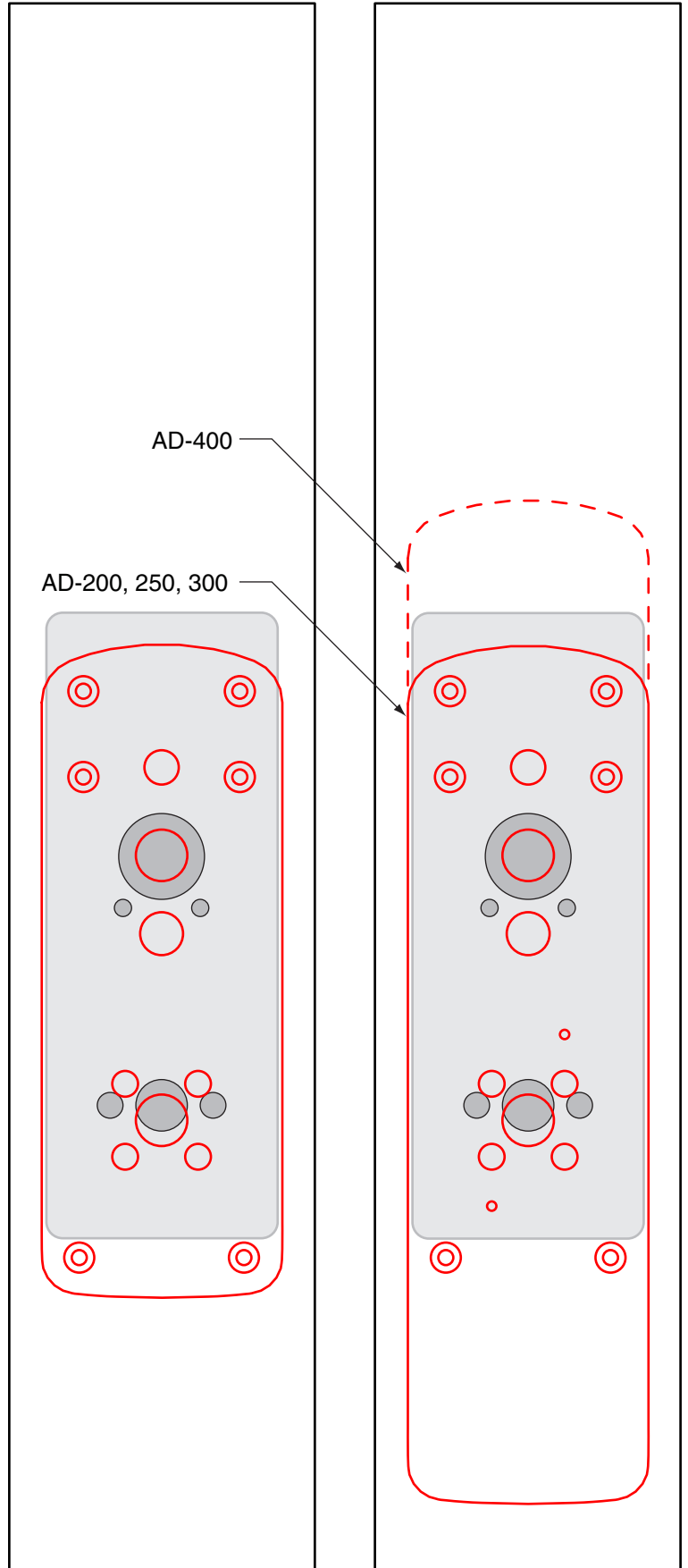

	Retrofitting From: Schlage KC5500
	To New Lock: Schlage AD-200-MS/MD Schlage AD-250-MS/MD Schlage AD-300-MS/MD Schlage AD-400-MS/MD
	Decorative Plates Required: n/a



Outside Face of Door

Inside Face of Door

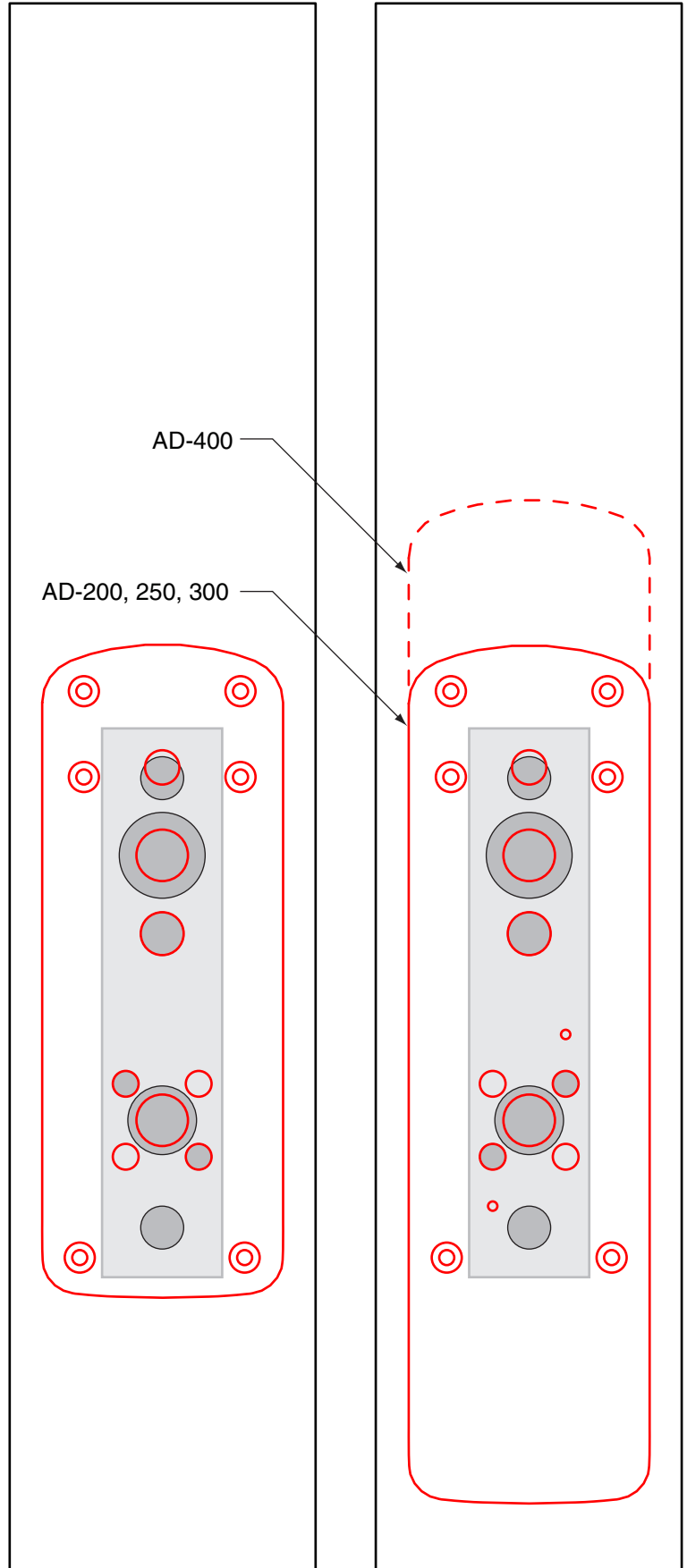

Schlage L/LV-9486

	Retrofitting From: Schlage L/LV-9486
	To New Lock: Schlage AD-200-MS/MD Schlage AD-250-MS/MD Schlage AD-300-MS/MD Schlage AD-400-MS/MD
	Decorative Plates Required: n/a



Outside Face of Door

Inside Face of Door

	Retrofitting From: Schlage MPM / 5500
	To New Lock: Schlage AD-200-MS/MD Schlage AD-250-MS/MD Schlage AD-300-MS/MD Schlage AD-400-MS/MD
	Decorative Plates Required: n/a

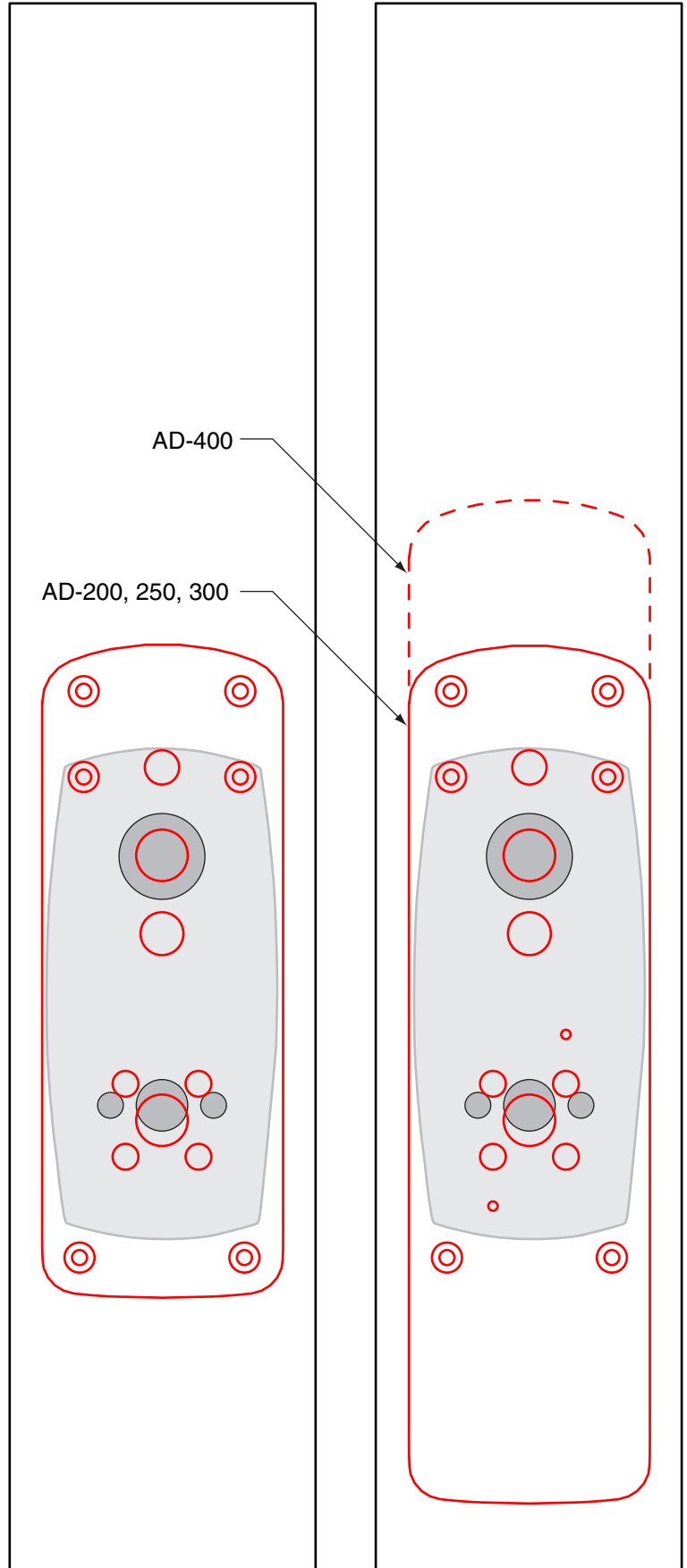





AD-400

AD-200, 250, 300

Outside Face of Door

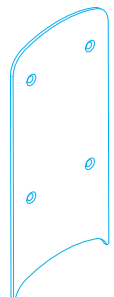
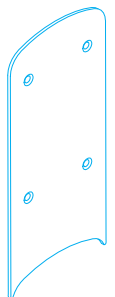
Inside Face of Door

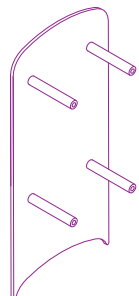
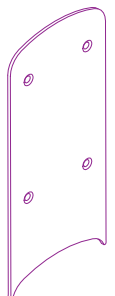

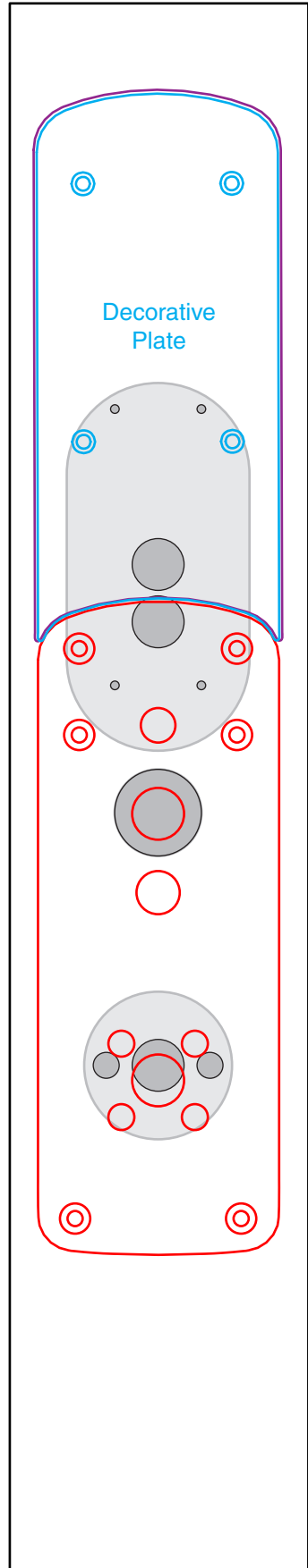

	Retrofitting From: Schlage WA5600 (1 of 2)	
	To New Lock: Schlage AD-200-MS/MD Schlage AD-250-MS/MD Schlage AD-300-MS/MD	
DECORATIVE PLATE CHOICES		
Surface Mounted Plates		
	Outside <u>23760309</u> 	Inside <u>23760309</u> 
-----OR-----		
Thru-Bolted Plates		
	Outside <u>23760291</u> 	Inside <u>23760309</u> 

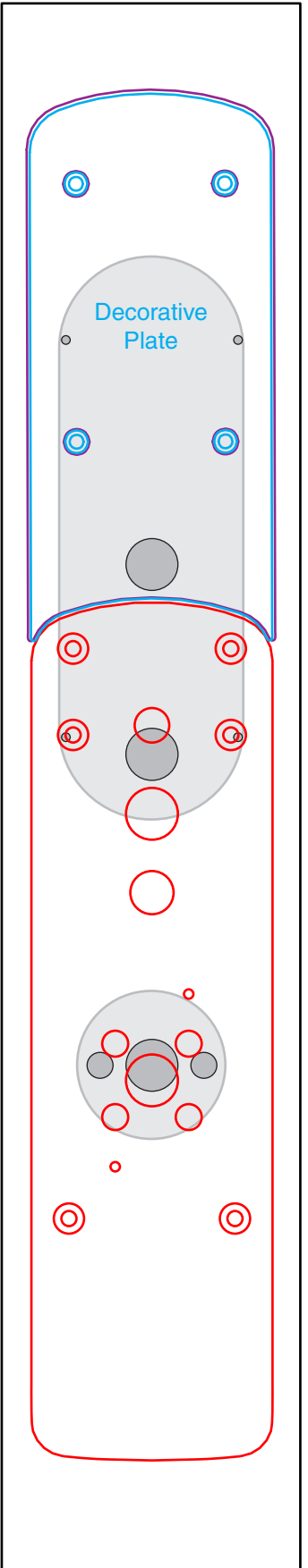

Outside Face of Door

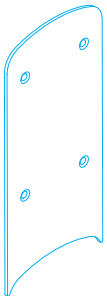

Inside Face of Door

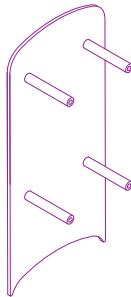
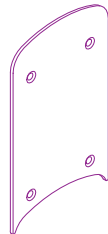

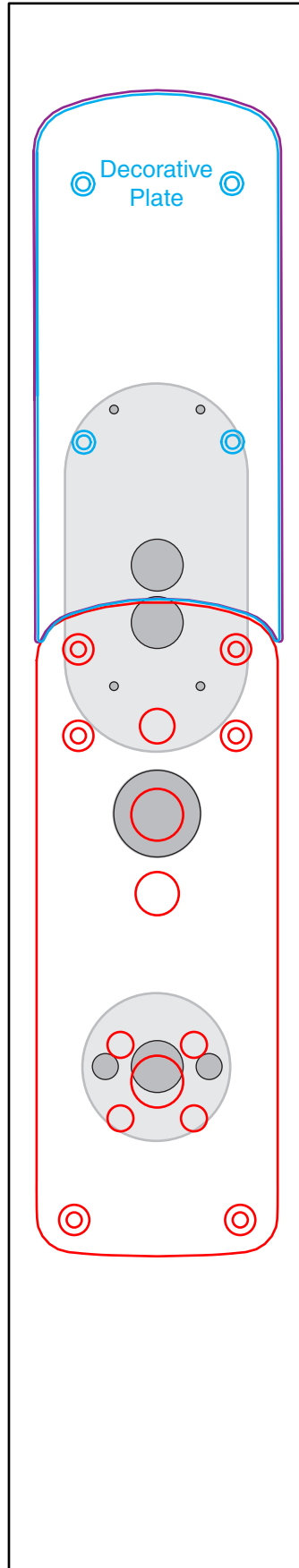
	Retrofitting From: Schlage WA5600 (2 of 2)
	To New Lock: Schlage AD-400-MS/MD
DECORATIVE PLATE CHOICES	
Surface Mounted Plates	
Outside <u>23760309</u>	Inside <u>23760283</u>
 	
-----OR-----	
Thru-Bolted Plates	
Outside <u>23760291</u>	Inside <u>23760317</u>
 	

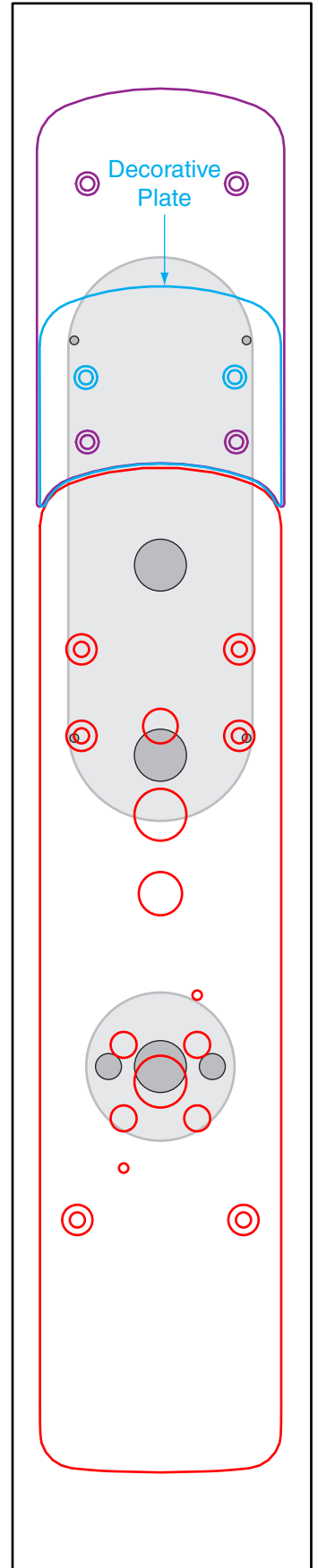

Outside Face of Door



Inside Face of Door

	Retrofitting From: Stanley 45H / HW-47H / HW-IDH
	To New Lock: Schlage AD-200-MS/MD Schlage AD-250-MS/MD Schlage AD-300-MS/MD Schlage AD-400-MS/MD
	Decorative Plates Required: n/a

AD-200, 250, 300

Note: Existing DPS hole will need to be plugged

AD-400

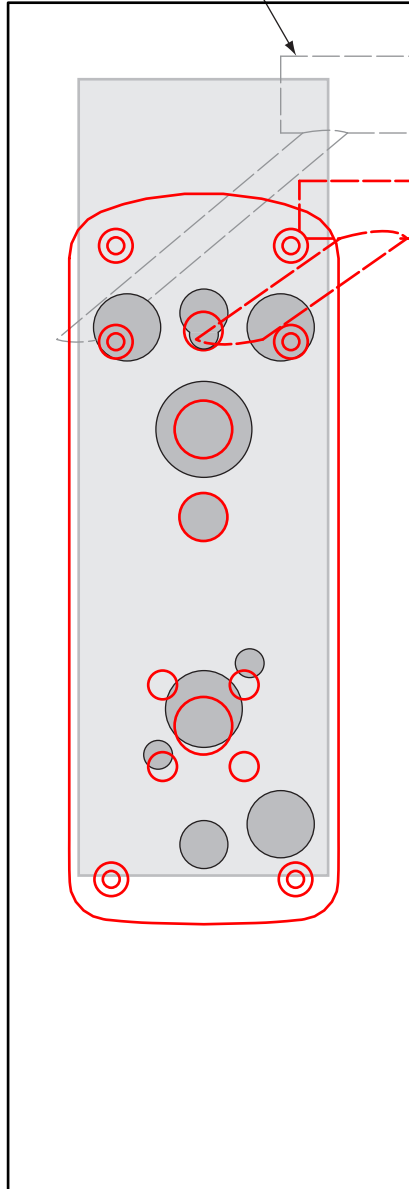



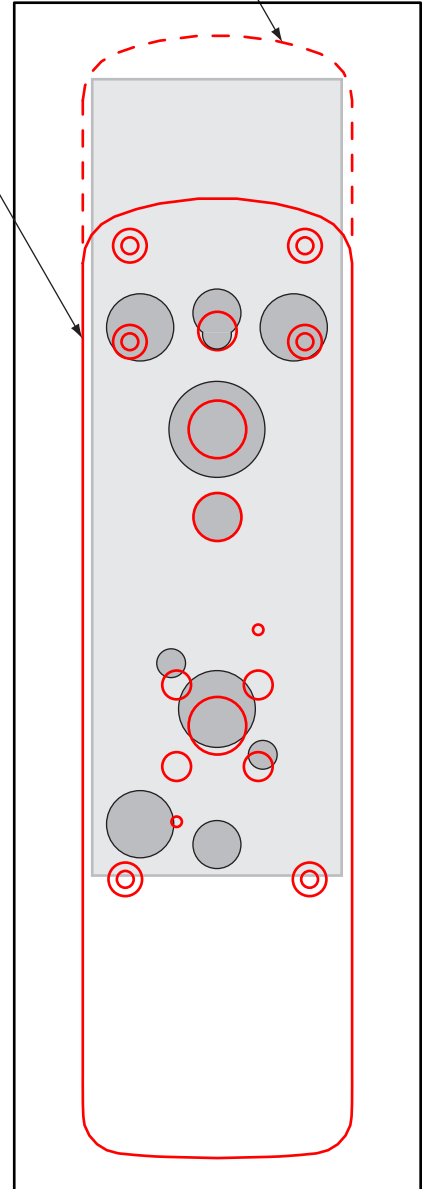

Outside Face of Door



Inside Face of Door

Best Exit Trim (on Von Duprin 98/99 Rim)

	Retrofitting From: Best Exit Trim (on Von Duprin 98/99 Rim)	
	To New Lock: Schlage AD-200-993 Schlage AD-250-993 Schlage AD-300-993 Schlage AD-400-993	
Decorative plate choices		
	Surface Mounted Exit Plate	
	Outside n/a	Inside <u>23631823</u> 
-----OR-----		
	Thru-Bolted / Under the Lock Plates	
	Outside n/a	Inside n/a

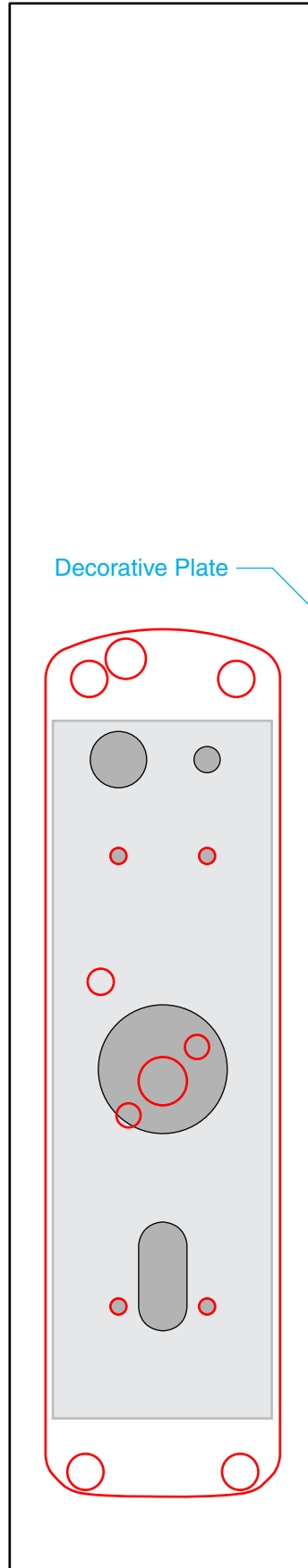

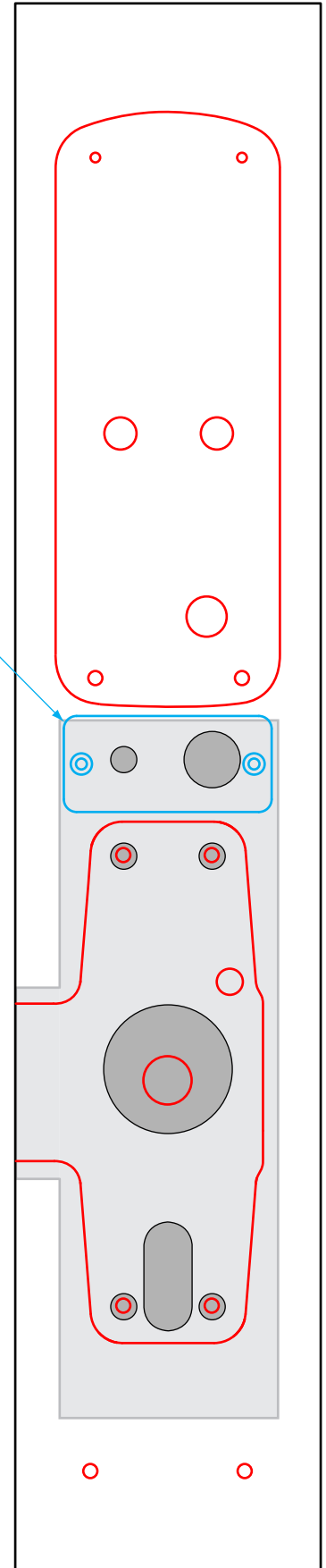

Outside Face of Door



Inside Face of Door

Kaba E-Plex 5700 Exit (on Von Duprin 98/99 Rim)

	Retrofitting From: Kaba E-Plex 5700 Exit (on Von Duprin 98/99 Rim)
	To New Lock: Schlage AD-200-993 Schlage AD-250-993 Schlage AD-300-993 Schlage AD-400-993
	Decorative Plates Required: n/a

Fill hole.
Sextbolt with 3/8" O.D. and
1/4" threads installed from
outside recommended.

countersink
1/4" thread
flat head screw
on interior side

countersink
1/4" thread
flat head screws
on exterior side

Fill holes, 2 places.
Sextbolts with 3/8" O.D. and
1/4" threads installed from
inside recommended.

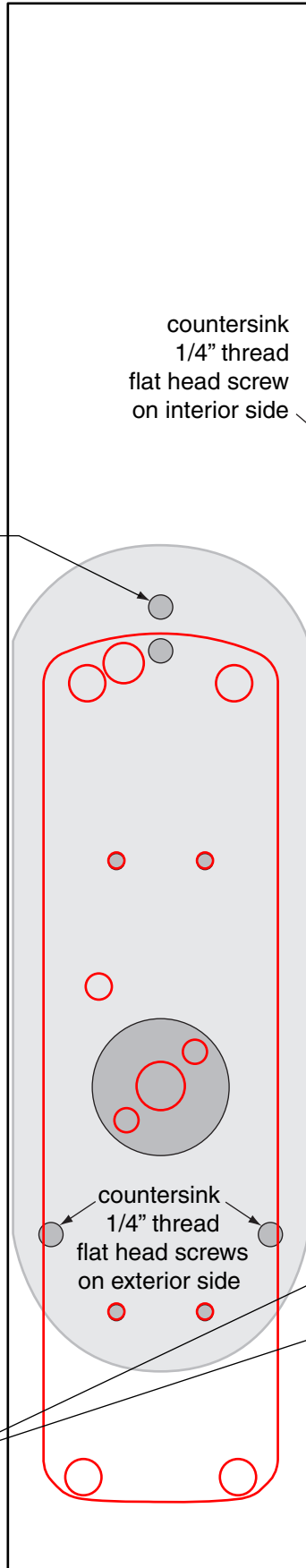

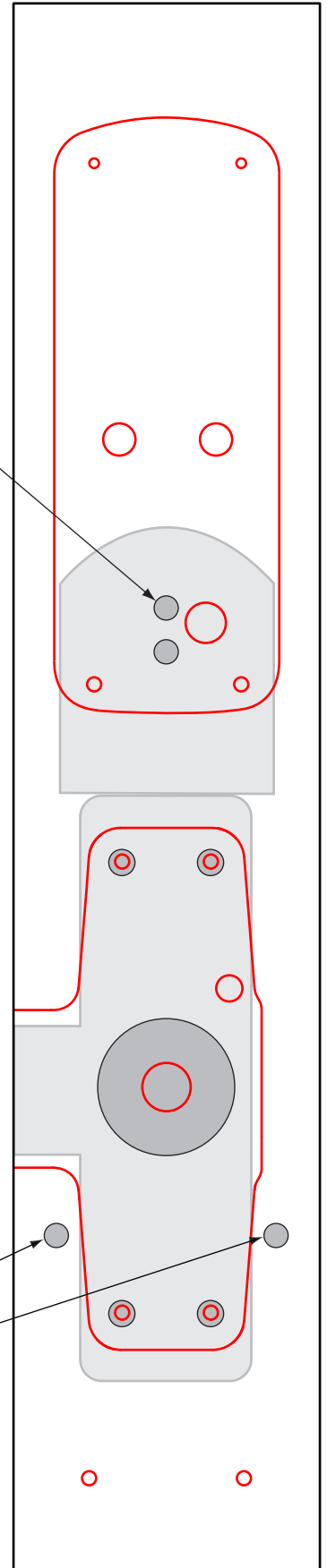

Outside Face of Door



Inside Face of Door

Sargent Profile Exit Trim (on Sargent 8800 Rim)

	Retrofitting From: Sargent Profile Exit Trim (on Sargent 8800 Rim)
	To New Lock: Schlage AD-200-993 Schlage AD-250-993 Schlage AD-300-993 Schlage AD-400-993
	Decorative Plates Required: n/a

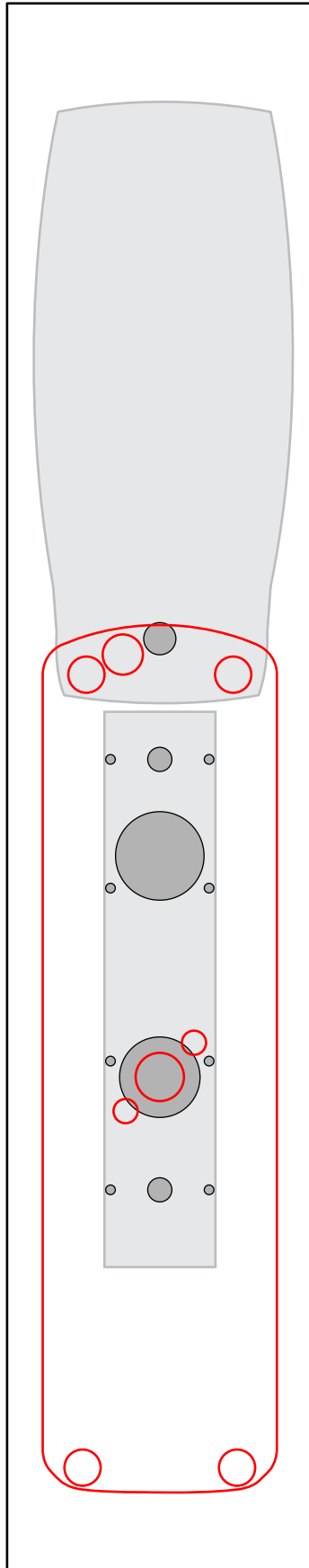

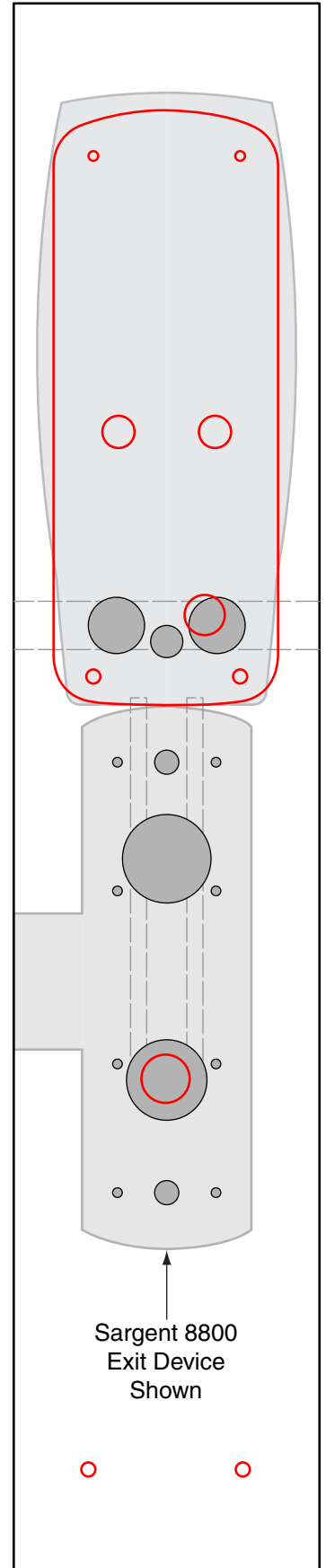

Outside Face of Door



Inside Face of Door

Schlage CO-100/200-993 Exit (on Von Duprin 98/99 Rim)

	Retrofitting From: Schlage CO-100/200-993 Exit (on Von Duprin 98/99 Rim)
	To New Lock: Schlage AD-200-993 Schlage AD-250-993 Schlage AD-300-993 Schlage AD-400-993
	Decorative Plates Required: n/a

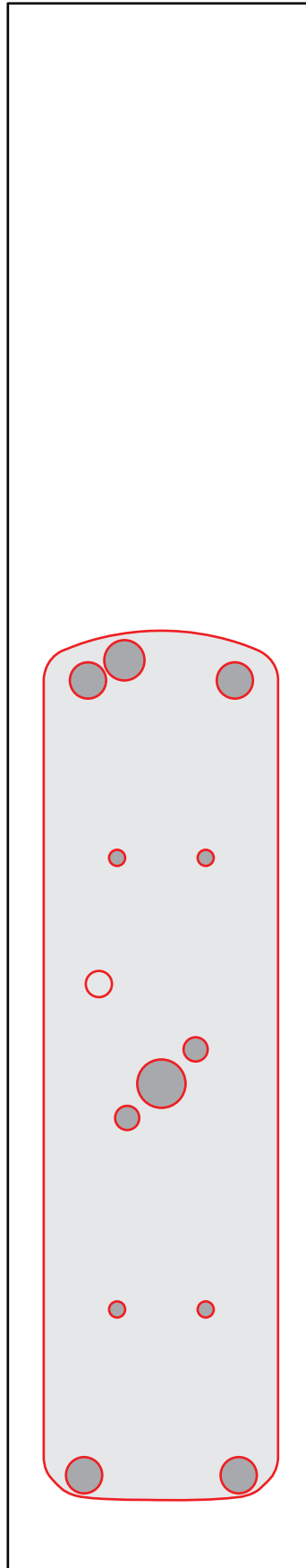

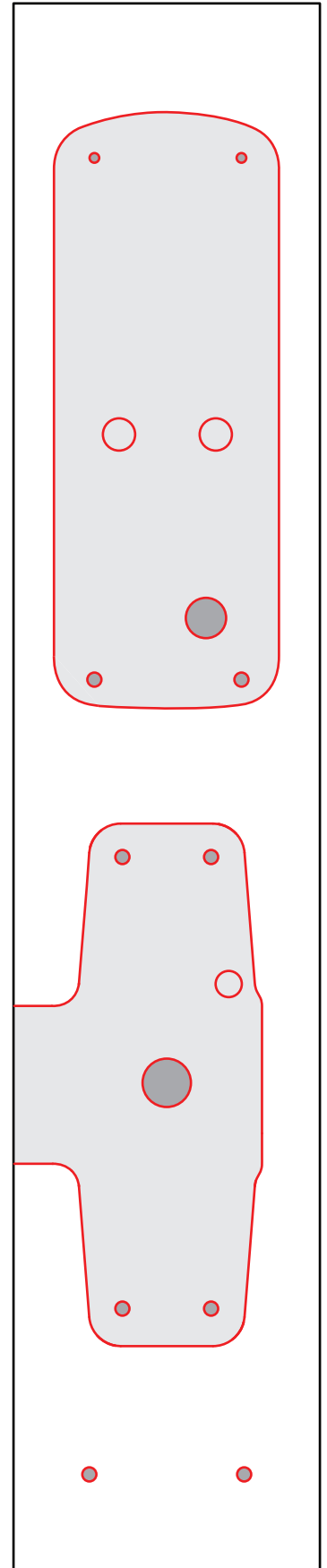

Outside Face of Door



Inside Face of Door

Schlage Pro 993 Exit (on Von Duprin 98/99 Rim)

	Retrofitting From: Schlage Pro 993 Exit (on Von Duprin 98/99 Rim)
	To New Lock: Schlage AD-200-993 Schlage AD-250-993 Schlage AD-300-993 Schlage AD-400-993
	Decorative Plates Required: n/a

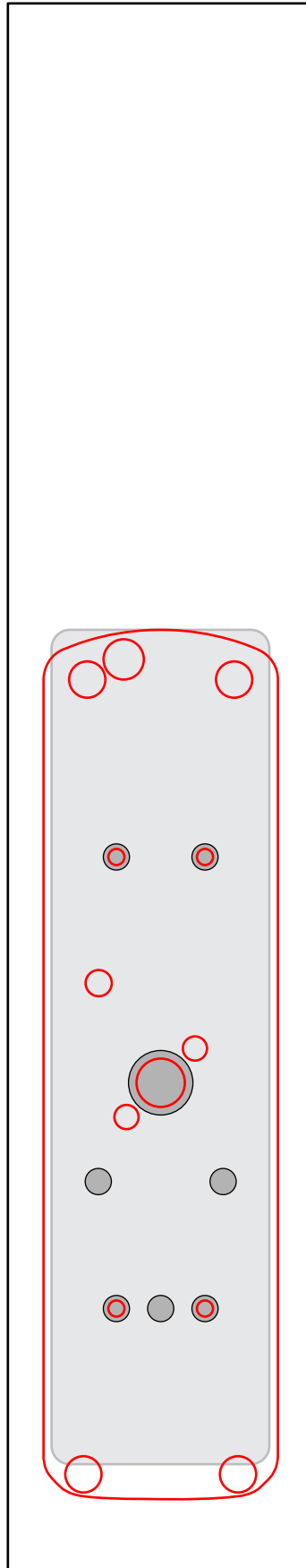



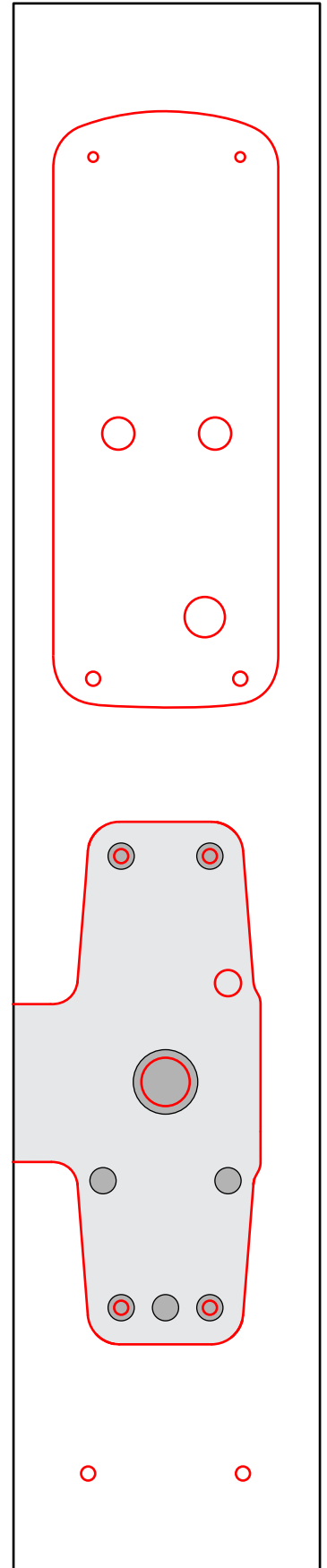

Outside Face of Door



Inside Face of Door

Schlage WA993 Exit (on Von Duprin 98/99 Rim)

	Retrofitting From: Schlage WA993 Exit (on Von Duprin 98/99 Rim)	
	To New Lock: Schlage AD-200-993 Schlage AD-250-993 Schlage AD-300-993 Schlage AD-400-993	
Decorative Plate Choices		
	Surface Mounted Exit Plate	
	Outside n/a	Inside <u>23631823</u> 
----- OR -----		
	Thru-Bolted / Under the Lock Plates	
	Outside n/a	Inside n/a

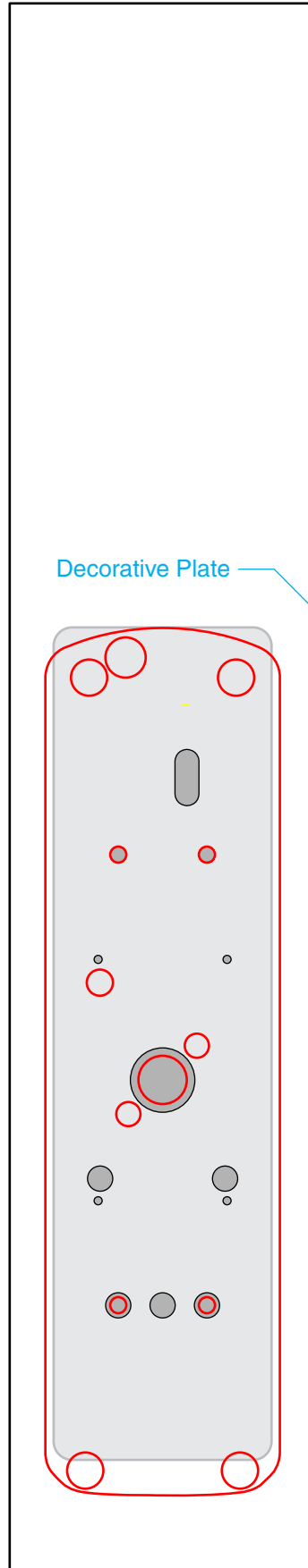

Outside Face of Door

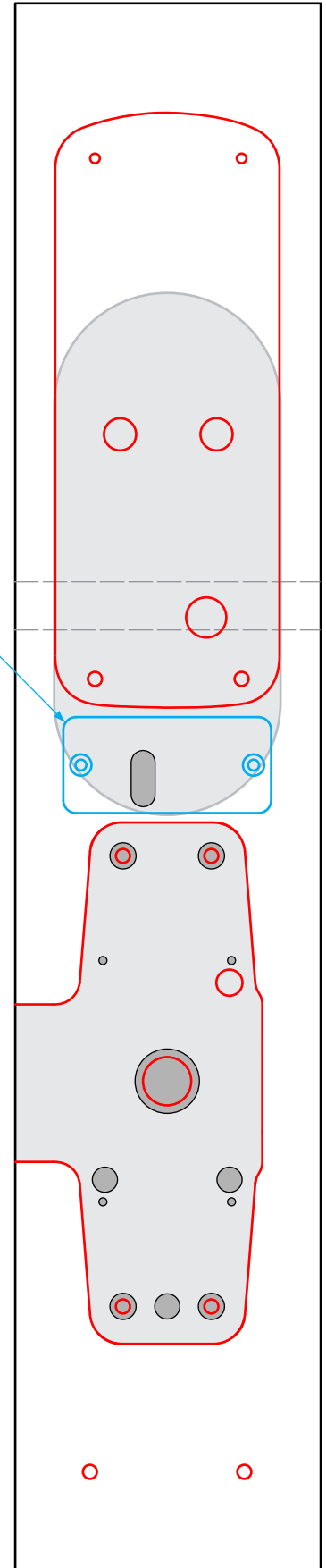



Inside Face of Door

Decorative Plates

Part Numbers and Descriptions

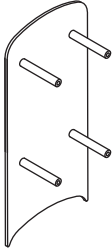
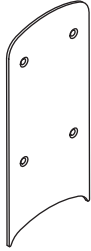
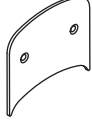
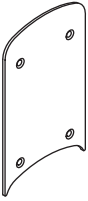
Cylindrical, Mortise, and Mortise Deadbolt

 <p>23760291 8" decorative plate with welded standoffs and fasteners</p>	 <p>23760309 8" decorative plate with fasteners</p>	 <p>23760283 3.2" decorative plate with fasteners</p>
 <p>23760317 6" decorative plate with fasteners</p>	 <p>23760259* 10.5" under the lock decorative plate (fasteners not necessary)</p>	 <p>23760275* 12" under the lock decorative plate (fasteners not necessary)</p>

Exit Trim

 <p>23631823 Exit trim decorative plate with fasteners</p>
--

*A single under the lock plate will add 0.075" to the door thickness. AD-Series Devices can be ordered for door thicknesses in increments of 0.125".

Finishes (available for all plates)	Examples - Customer Order Suffix Configuration
605 Bright Brass	23760267-605
630 Satin Stainless Steel	23760259-630
643e Aged Bronze	23760291-643e + 23760309-643e

Customer Service

1-877-671-7011

www.allegion.com/us

