

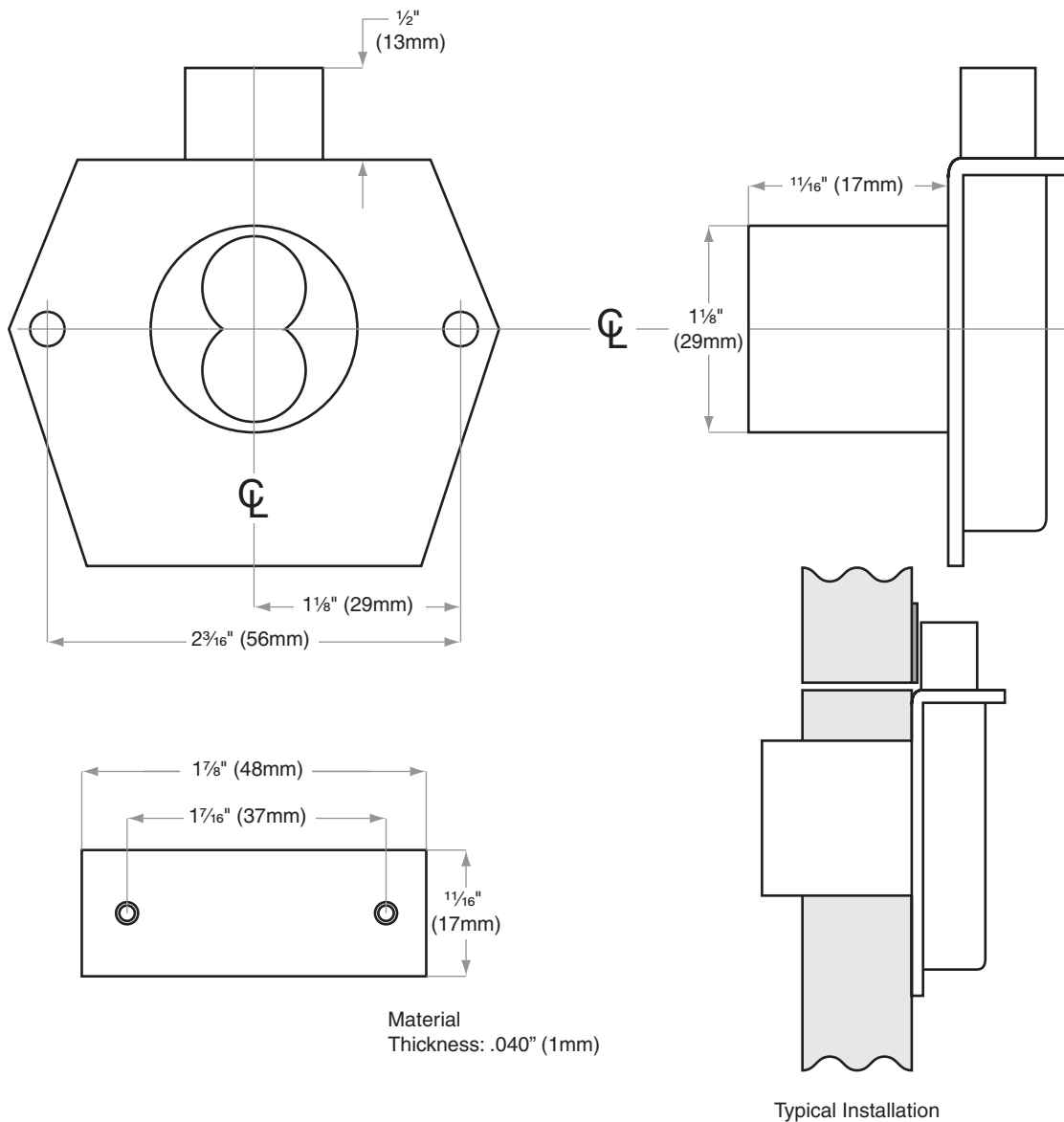

CL-Series

CL775

Door Type: Wood, Composite or Metal
Door Thickness: $\frac{7}{8}$ " (22 mm), 1" (25 mm) $1\frac{1}{8}$ " (29 mm)



Dimensions shown in parentheses () are in millimeters.