



# CO-Series Retrofit Template Overlays



## Contents

2 Alarm Lock Trilogy	27 VIP 5100
3 Best 5-6-8-9K	28 Alarm Lock DL3500
4 Best BASIS 93KBV	29 Corbin ML2000
5 Best IDH-MAX	30 Kaba E5700
6 Cal-Royal CR3000	31 Onity-HT
7 Cal-Royal PL7000	32 Persona 4000R / 5000R
8 Cal-Royal RS2000	33 Sargent 7900 Series Lock Body Only
9 Kaba 1000 (Lockout function)	34 Sargent Profile Series Mortise
10 Kaba 1000 (Passage function)	35 Schlage AD200/250/300/400-MS/MD
11 Kaba 5000	36 Schlage CM5600
12 Kaba L1000	37 Schlage CM-CL-PRO-5500
13 Onity-HT	38 Schlage KC5500
14 Sargent 6/7-GX-11 Line	39 Schlage L/LV-9486
15 Sargent 8/9 Line	40 Schlage MPM / 5500
16 Sargent 10 Line	41 Schlage WA5600
17 Sargent 7500	42 Stanley 45H / HW-47H / HW-IDH
18 Sargent DL-8-9	43 Best Exit Trim (on Von Duprin 98/99 Rim)
19 Sargent Profile 10G77	44 Kaba E-Plex 5700 Exit (on Von Duprin 98/99 Rim)
20 Schlage AD-200/250/300/400-CY	45 Sargent Profile Exit Trim (on Sargent 8800 Rim)
21 Schlage CL5200-CM5200	46 Schlage AD-200/250/300/400-993 Exit (on Von Duprin 98/99 Rim)
22 Schlage CM5100-HW	47 Schlage Pro 993 Exit (on Von Duprin 98/99 Rim)
23 Schlage CM-CL-PRO-5100	48 Schlage WA993 Exit (on Von Duprin 98/99 Rim)
24 Schlage KC5100	49 Decorative Plates
25 Schlage ND Series	
26 Schlage WA5200	

# Alarm Lock Trilogy

	<b>Retrofitting From:</b> Alarm Lock Trilogy (All Cylindrical)
	<b>To New Lock:</b> Schlage CO-100-CY Schlage CO-200-CY
	<b>Decorative Plates Required:</b> n/a

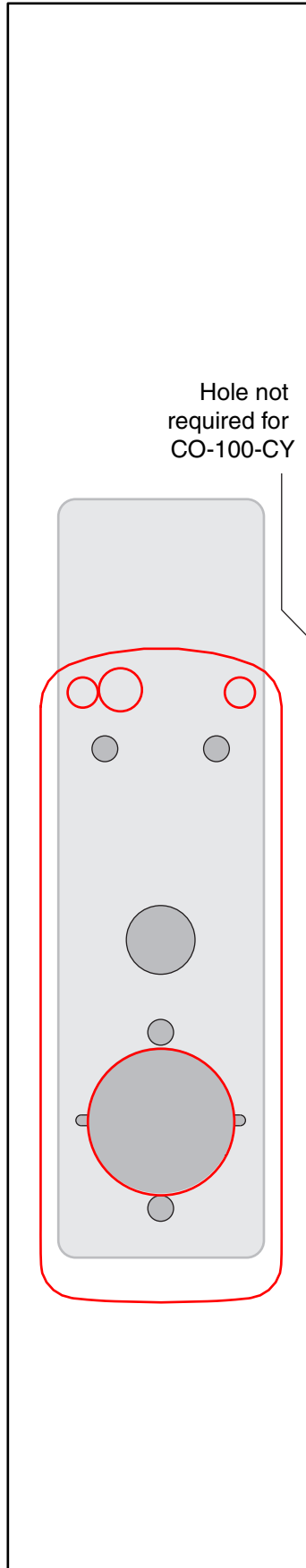

Outside Face of Door

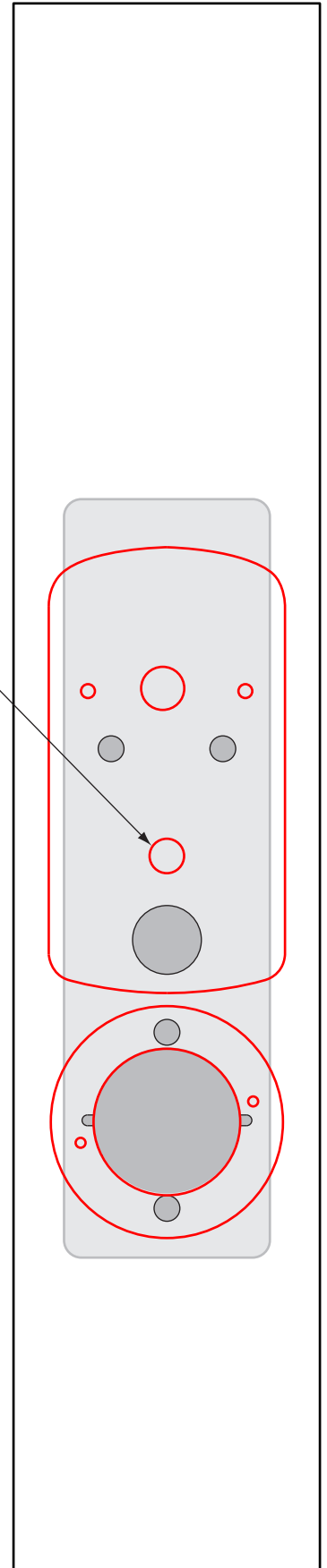

Inside Face of Door



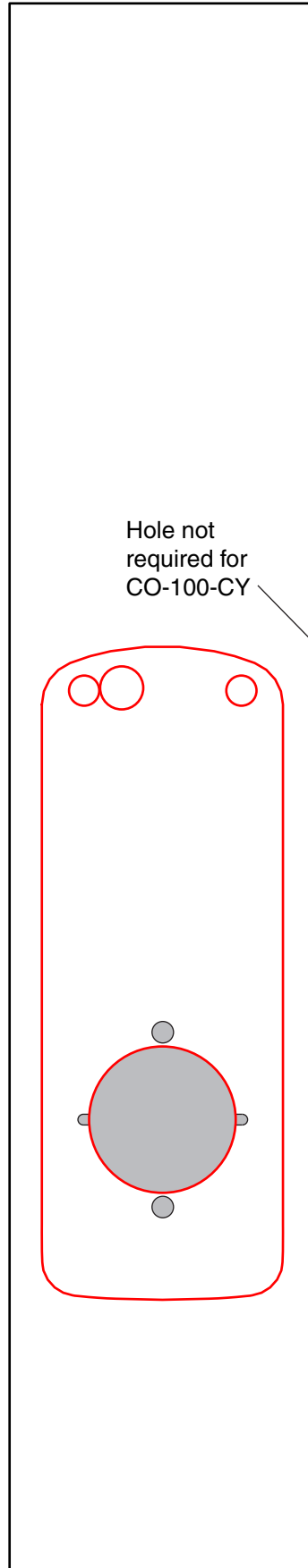

	<b>Retrofitting From:</b> Best 5-6-8-9K
	<b>To New Lock:</b> Schlage CO-100-CY Schlage CO-200-CY
	<b>Decorative Plates Required:</b> n/a

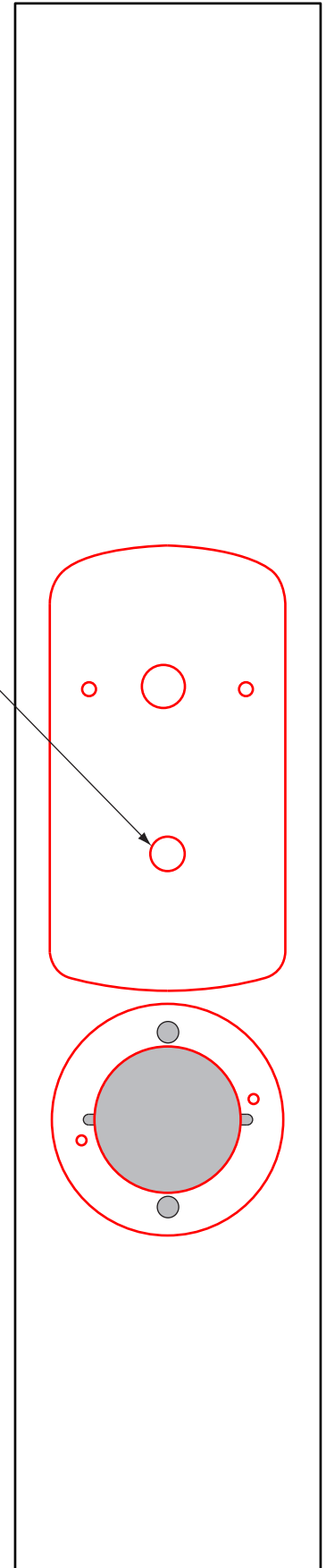

Outside Face of Door



Inside Face of Door

	<b>Retrofitting From:</b> Best BASIS 93KBV	
	<b>To New Lock:</b> Schlage CO-100-CY Schlage CO-200-CY	
<b>Decorative Plate Choices</b>		
<b>Surface Mounted Plates</b>		
	<b>Outside</b> n/a	<b>Inside</b> n/a
----- OR -----		
<b>Under the Lock Plates</b>		
	<b>Outside</b> n/a	<b>Inside</b> <u>23760275*</u>
		

\*A single under the lock plate will add 0.075" to the door thickness. CO Series Devices can be ordered for door thicknesses by increments of 0.125".

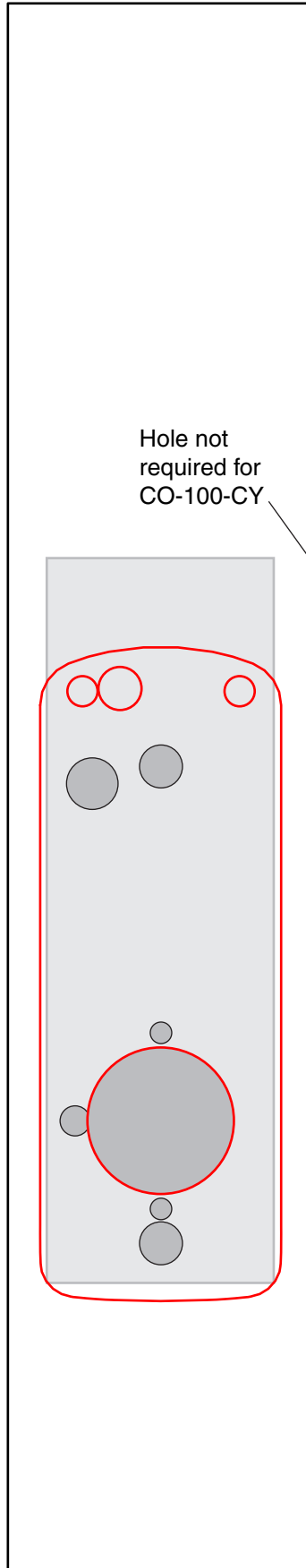



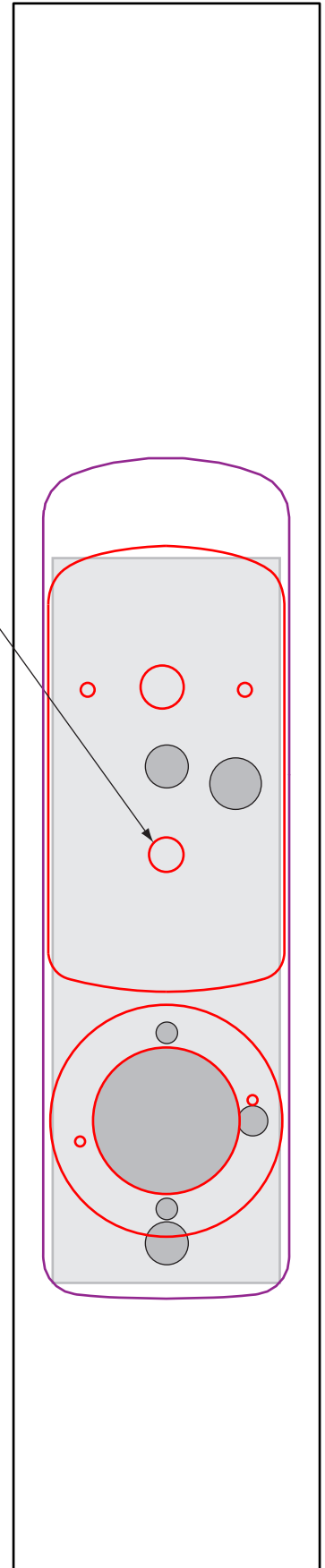

Outside Face of Door



Inside Face of Door

Best IDH-MAX

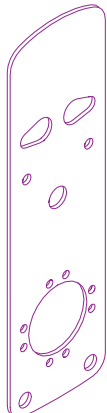
	<b>Retrofitting From:</b> Best IDH-MAX	
	<b>To New Lock:</b> Schlage CO-100-CY Schlage CO-200-CY	
<b>Decorative Plate Choices</b>		
<b>Surface Mounted Plates</b>		
	<b>Outside</b> n/a	<b>Inside</b> n/a
----- OR -----		
<b>Under the Lock Plates</b>		
	<b>Outside</b> n/a	<b>Inside</b> <u>23760275*</u>
		

\*A single under the lock plate will add 0.075" to the door thickness. CO Series Devices can be ordered for door thicknesses by increments of 0.125".

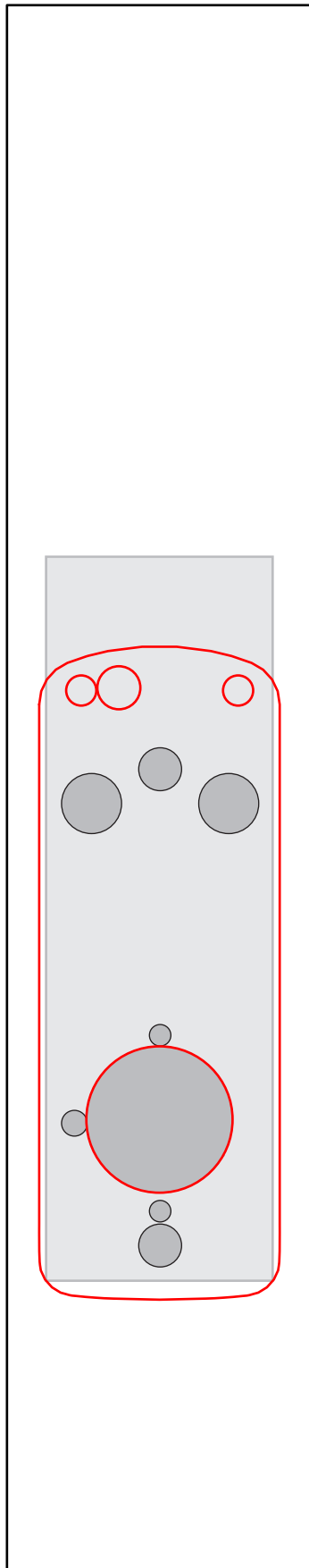

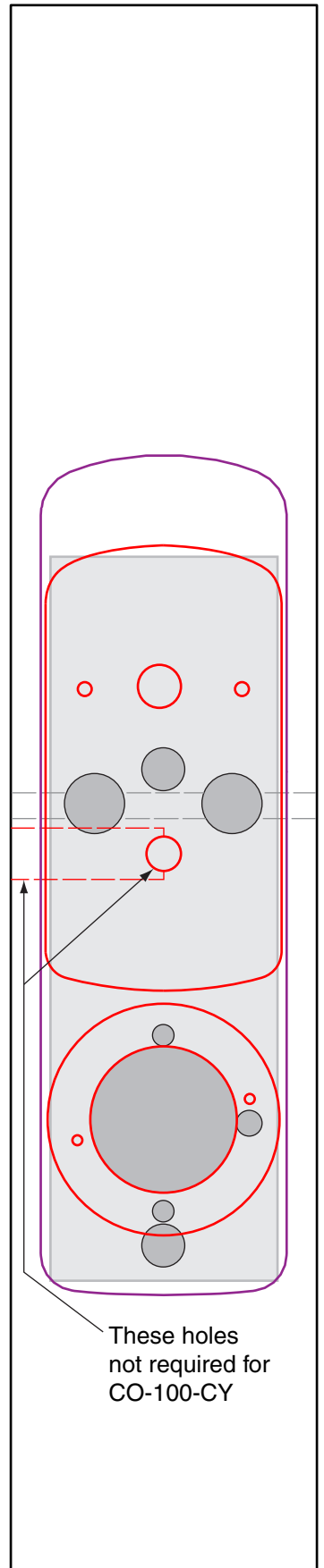

Outside Face of Door



Inside Face of Door

# Cal-Royal CR3000

	<b>Retrofitting From:</b> Cal-Royal CR3000
	<b>To New Lock:</b> Schlage CO-100-CY Schlage CO-200-CY
	<b>Decorative Plates Required:</b> n/a

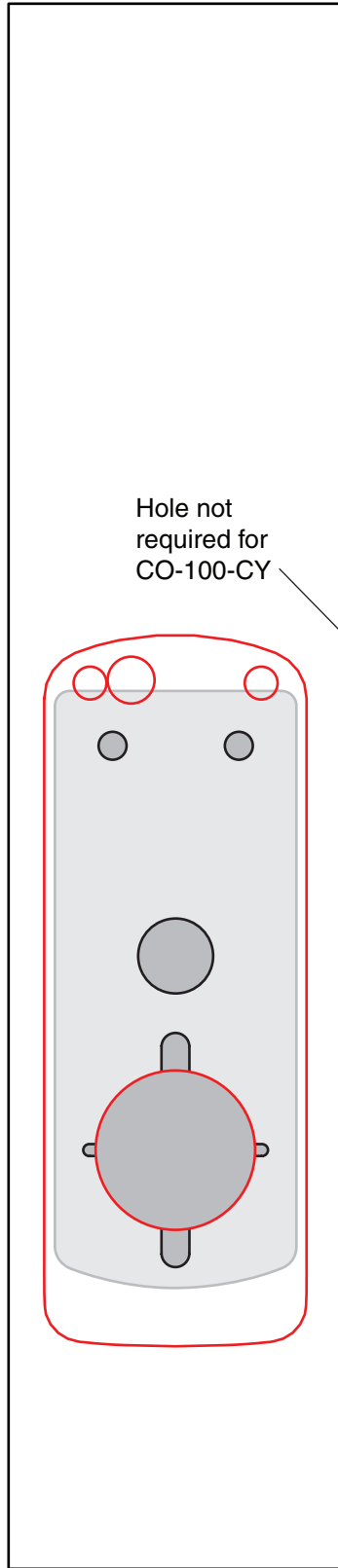

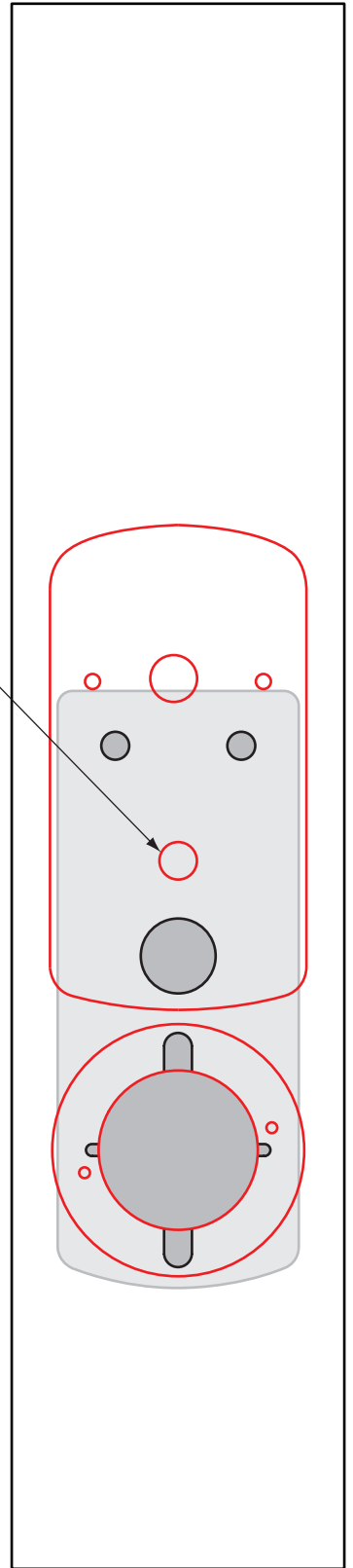

Outside Face of Door



Inside Face of Door

# Cal-Royal PL7000

	<b>Retrofitting From:</b> Cal-Royal PL7000
	<b>To New Lock:</b> Schlage CO-100-CY Schlage CO-200-CY
	<b>Decorative Plates Required:</b> n/a

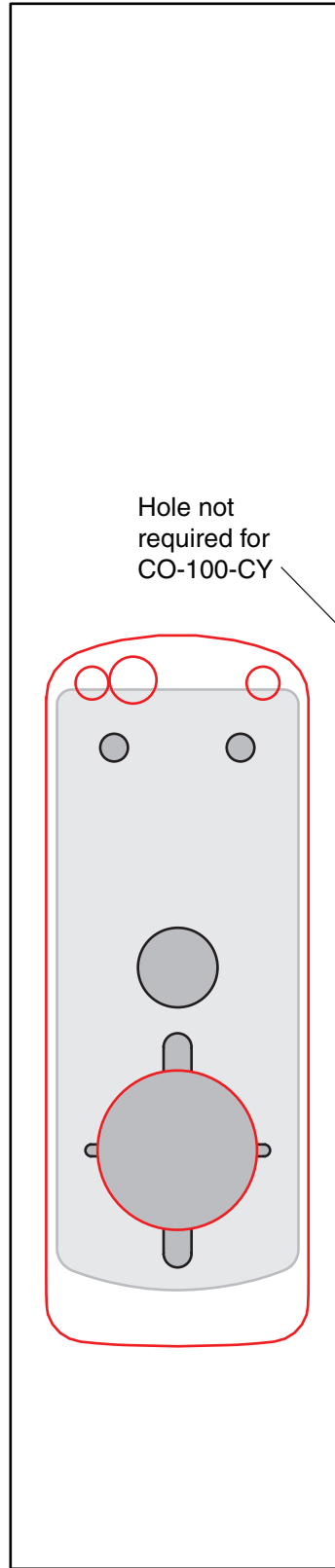

Outside Face of Door

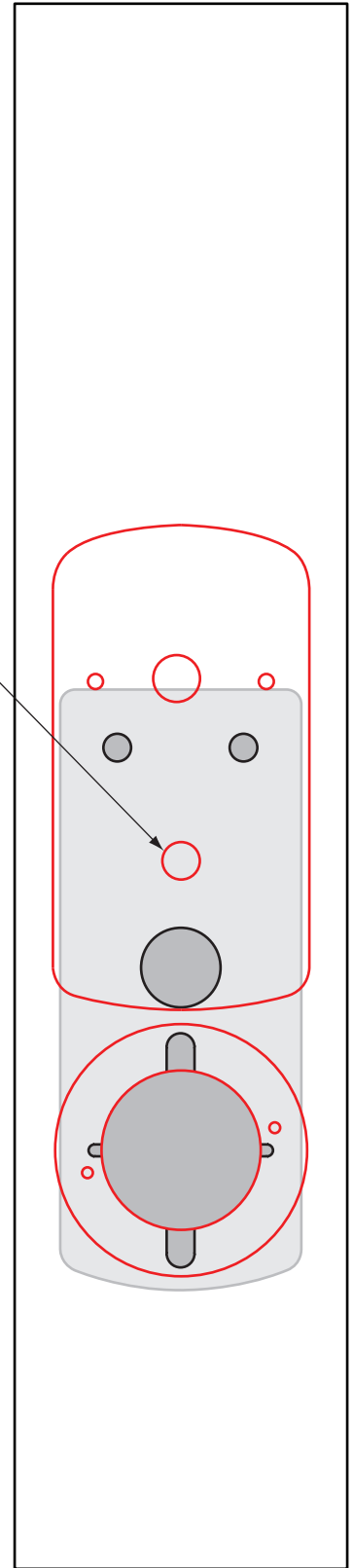

Inside Face of Door



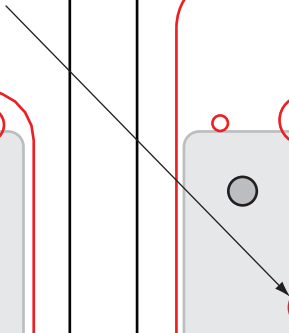

Hole not required for CO-100-CY







# Kaba 1000 (Lockout function)

	<b>Retrofitting From:</b> Kaba 1000 (Lockout function)	
	<b>To New Lock:</b> Schlage CO-100-CY Schlage CO-200-CY	
<b>Decorative Plate Choices</b>		
	<b>Surface Mounted Plates</b>	
	<b>Outside</b> n/a	<b>Inside</b> n/a
-----OR-----		
	<b>Under the Lock Plates</b>	
	<b>Outside</b> n/a	<b>Inside</b> <u>23760275*</u>

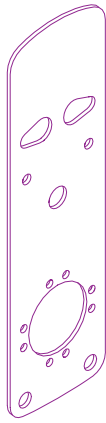

\*A single under the lock plate will add 0.075" to the door thickness. CO Series Devices can be ordered for door thicknesses by increments of 0.125".

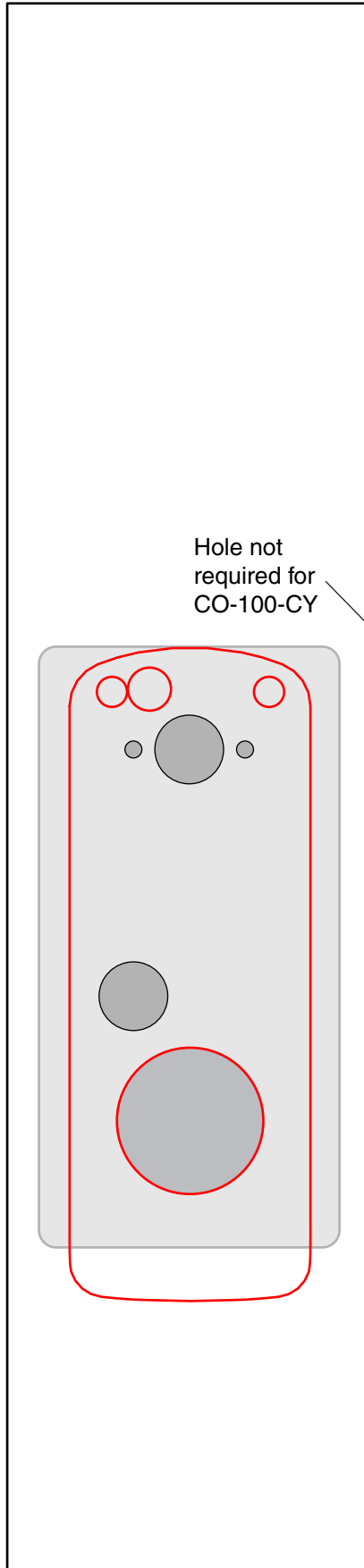

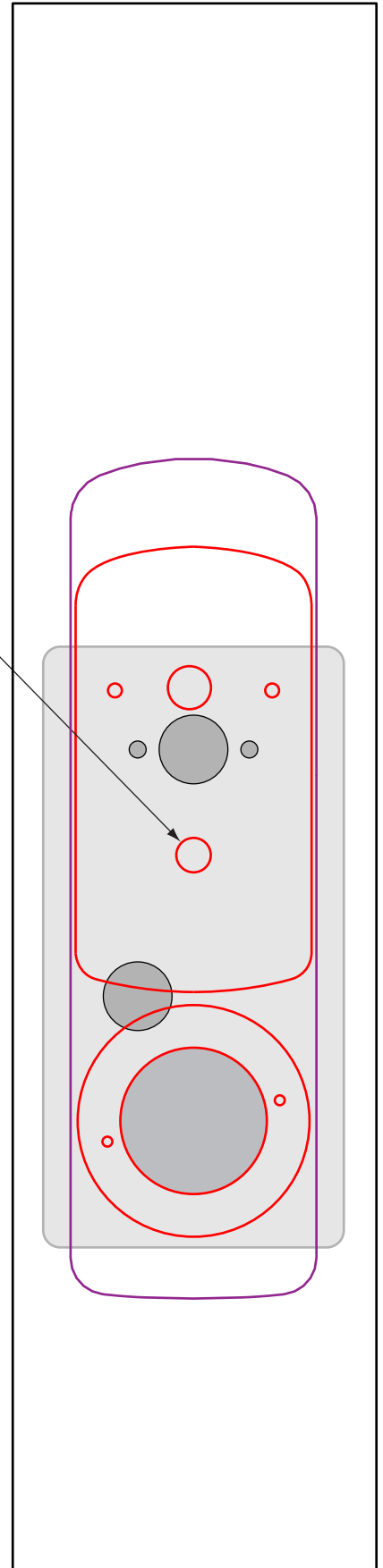

**Outside Face of Door**



**Inside Face of Door**

# Kaba 1000 (Passage function)

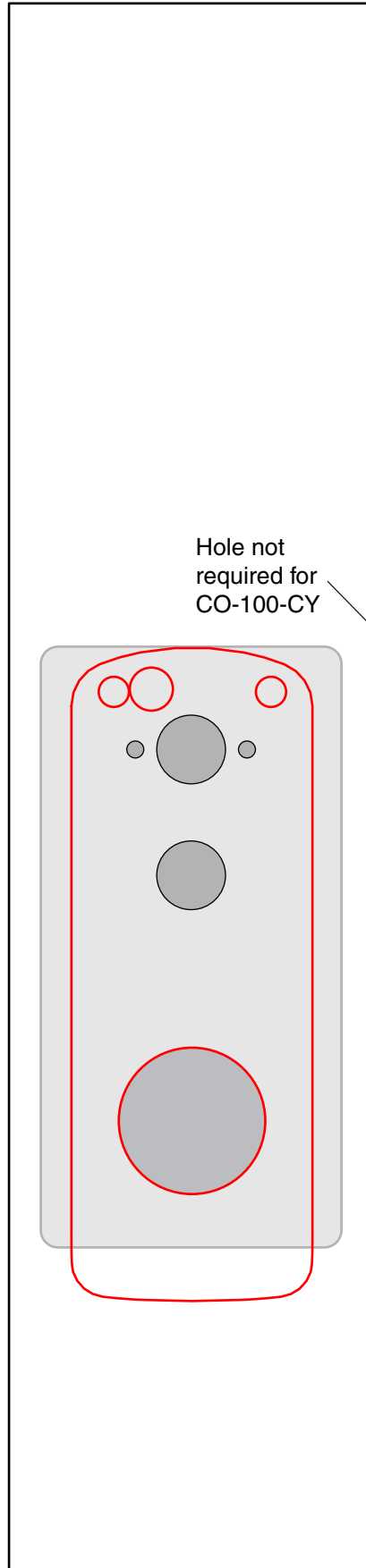

	<b>Retrofitting From:</b> Kaba 1000 (Passage function)
	<b>To New Lock:</b> Schlage CO-100-CY Schlage CO-200-CY
	<b>Decorative Plates Required:</b> n/a

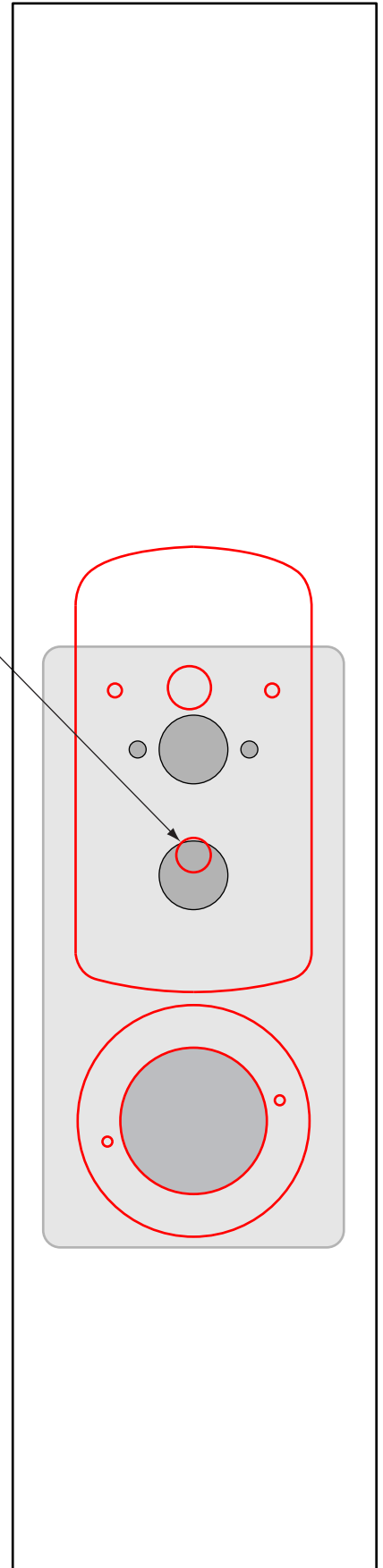

Outside Face of Door



Inside Face of Door

	<b>Retrofitting From:</b> Kaba 5000
	<b>To New Lock:</b> Schlage CO-100-CY Schlage CO-200-CY
	<b>Decorative Plates Required:</b> n/a

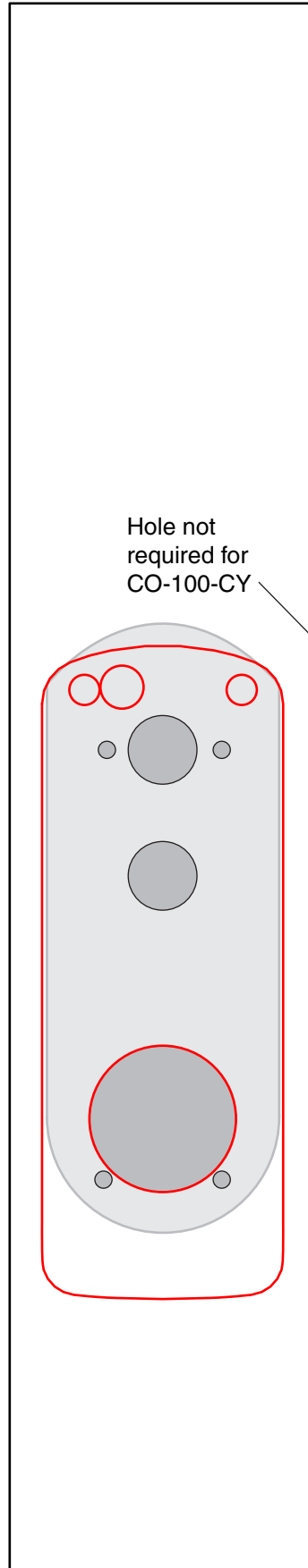

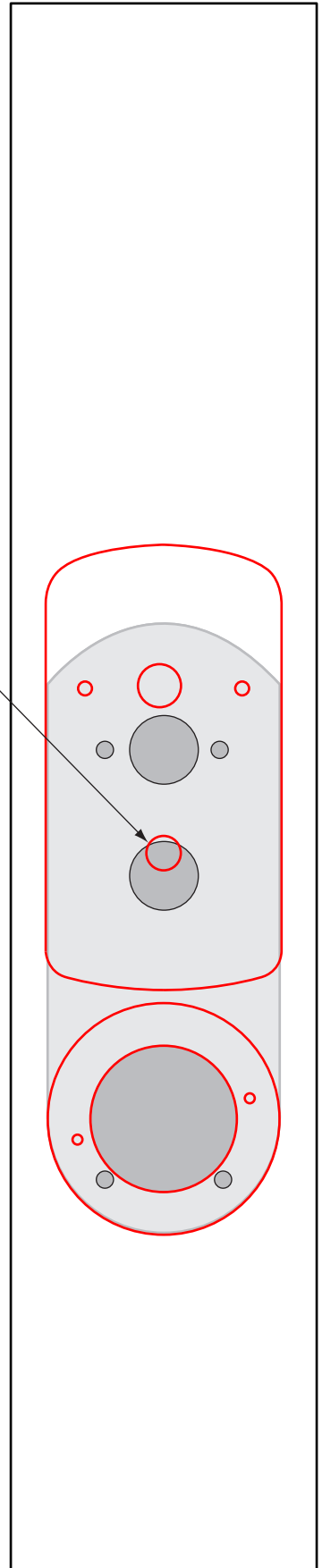

Hole not required for CO-100-CY

Outside Face of Door





Inside Face of Door

# Kaba L1000

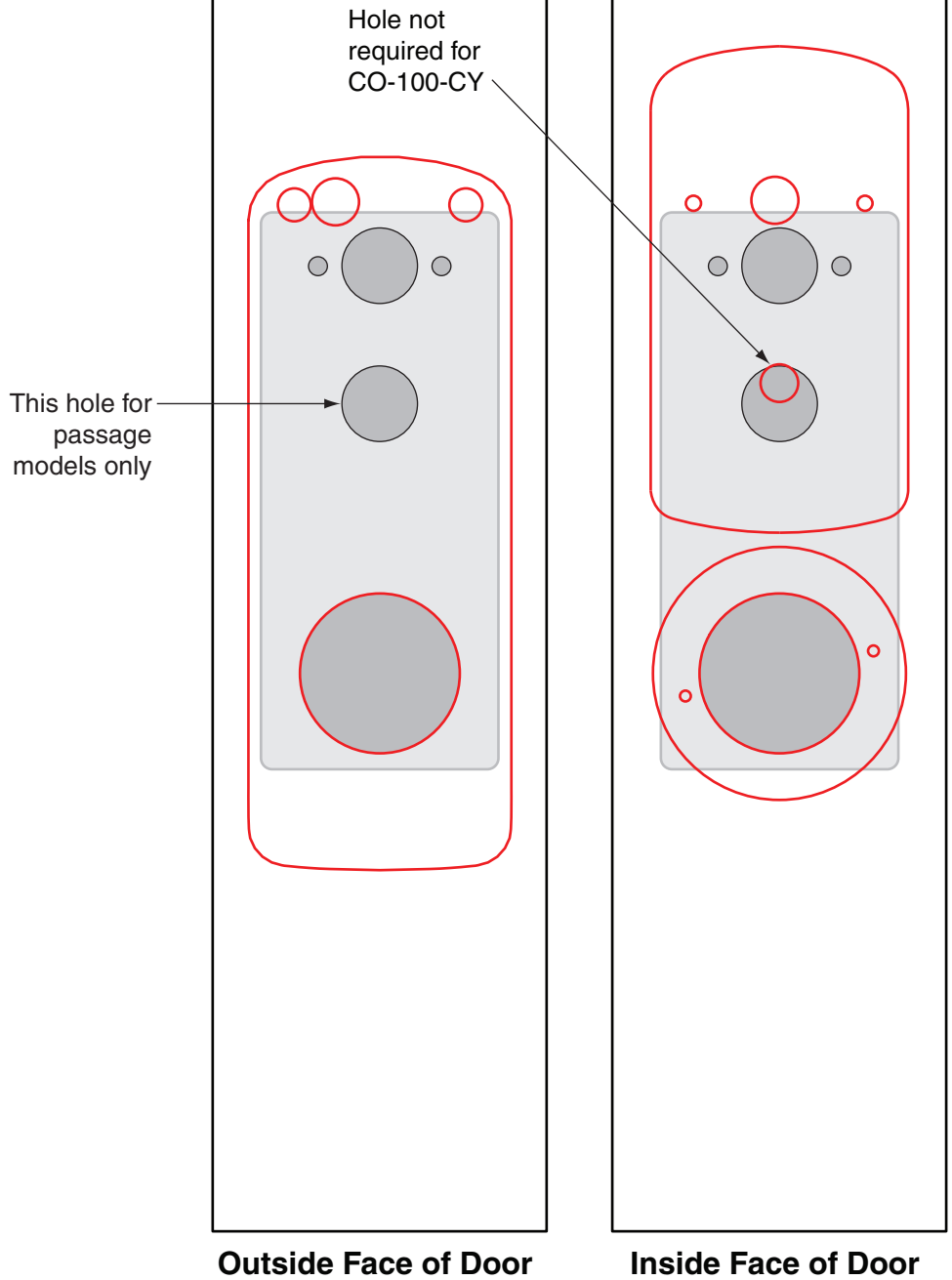
	<b>Retrofitting From:</b> Kaba L1000
	<b>To New Lock:</b> Schlage CO-100-CY Schlage CO-200-CY
	<b>Decorative Plates Required:</b> n/a



# Onity-HT

	<b>Retrofitting From:</b> Onity-HT
	<b>To New Lock:</b> Schlage CO-100-CY Schlage CO-200-CY
	<b>Decorative Plates Required:</b> n/a

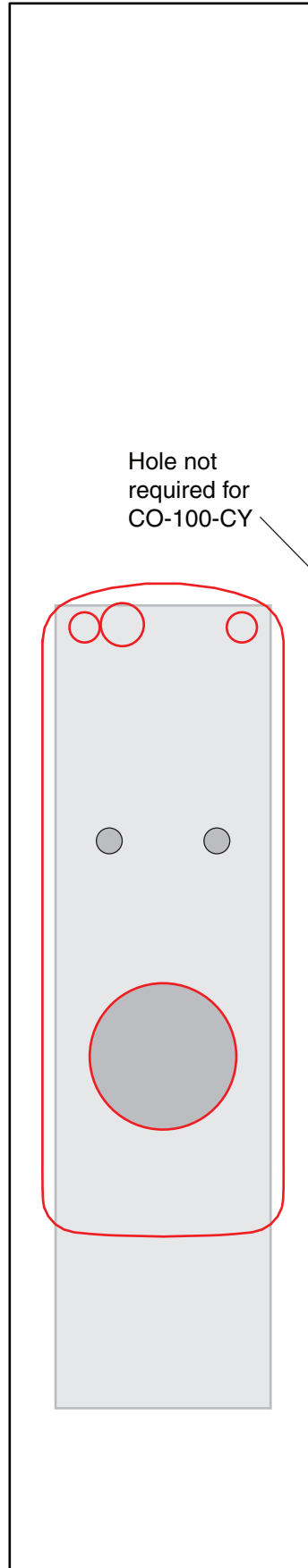

Outside Face of Door

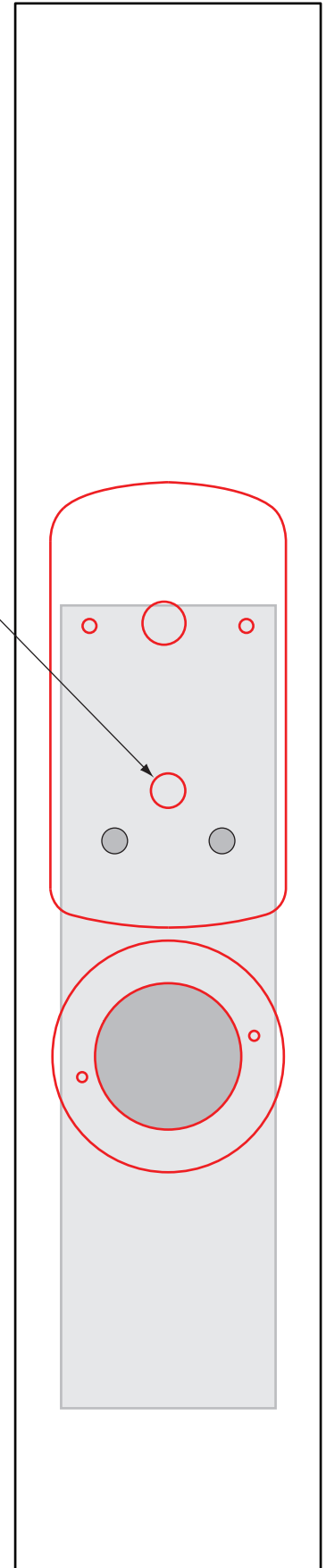

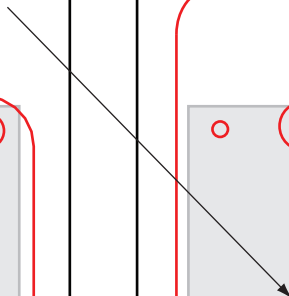

Inside Face of Door

Hole not required for CO-100-CY



Sargent 6/7-GX-11 Line

	<b>Retrofitting From:</b> Sargent 6/7-GX-11 Line
	<b>To New Lock:</b> Schlage CO-100-CY Schlage CO-200-CY
	<b>Decorative Plates Required:</b> n/a

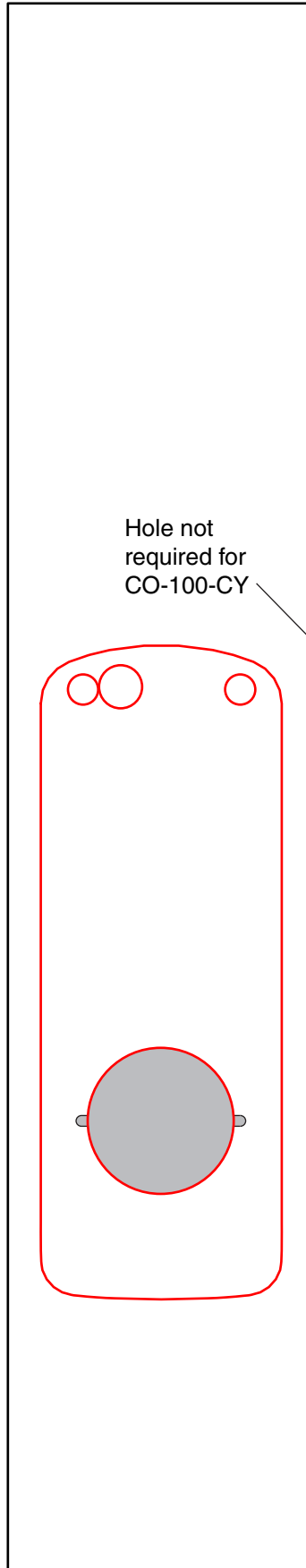

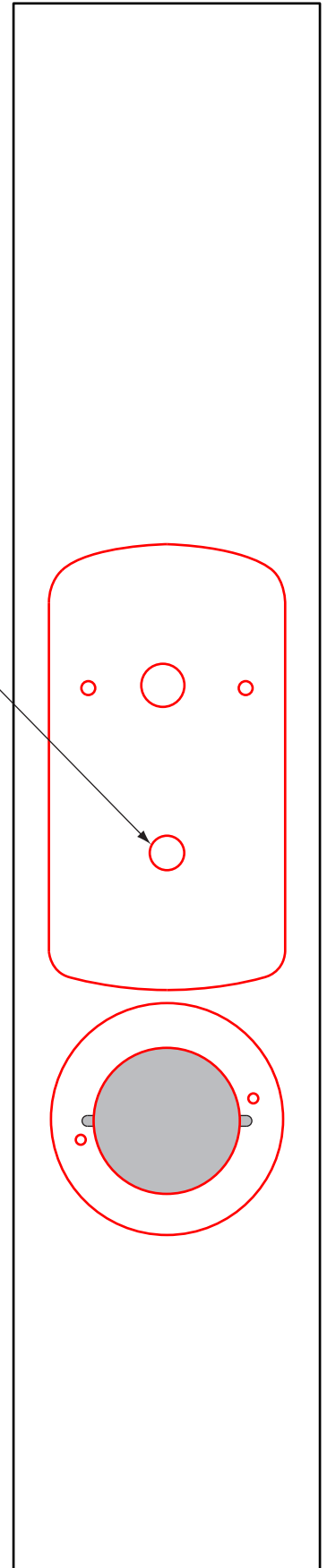

Outside Face of Door



Inside Face of Door

Hole not required for CO-100-CY

# Sargent 8/9 Line

	<b>Retrofitting From:</b> Sargent 8/9 Line
	<b>To New Lock:</b> Schlage CO-100-CY Schlage CO-200-CY
	<b>Decorative Plates Required:</b> n/a

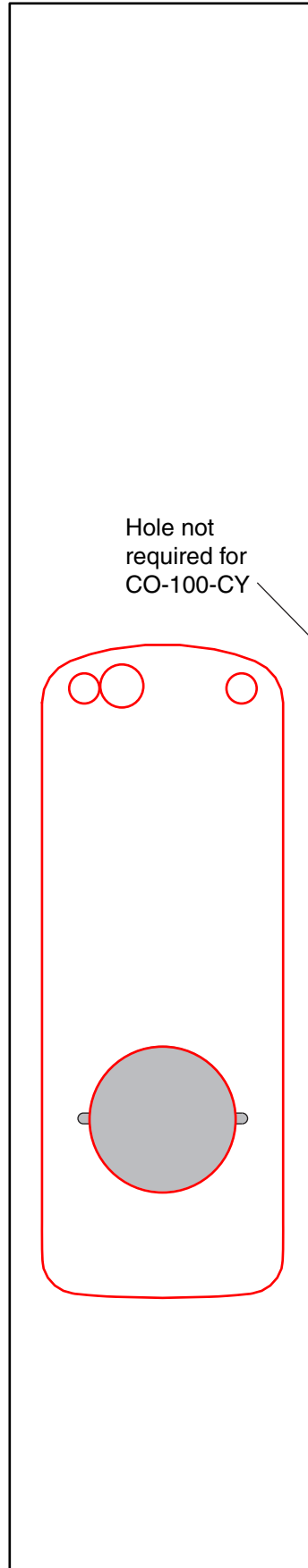

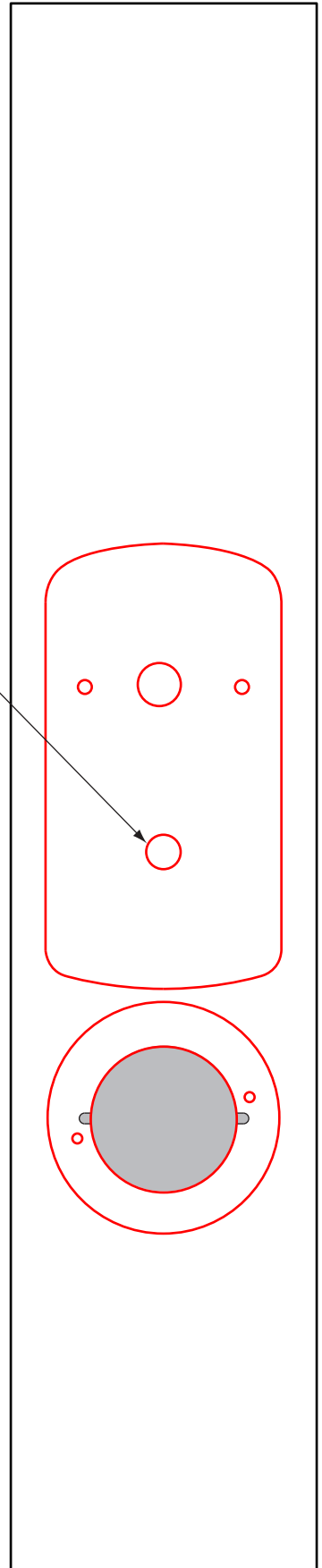

Outside Face of Door



Inside Face of Door

Hole not required for CO-100-CY

# Sargent 10 Line

	<b>Retrofitting From:</b> Sargent 10 Line
	<b>To New Lock:</b> Schlage CO-100-CY Schlage CO-200-CY
	<b>Decorative Plates Required:</b> n/a

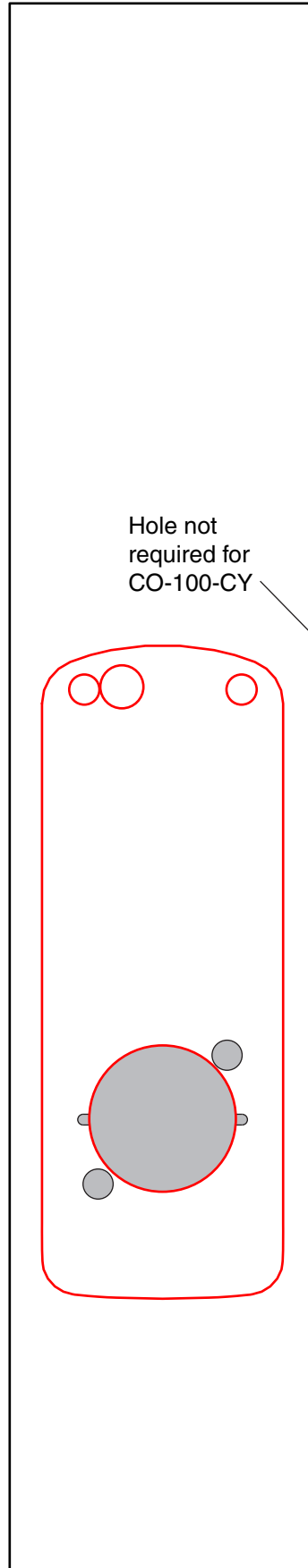

Outside Face of Door

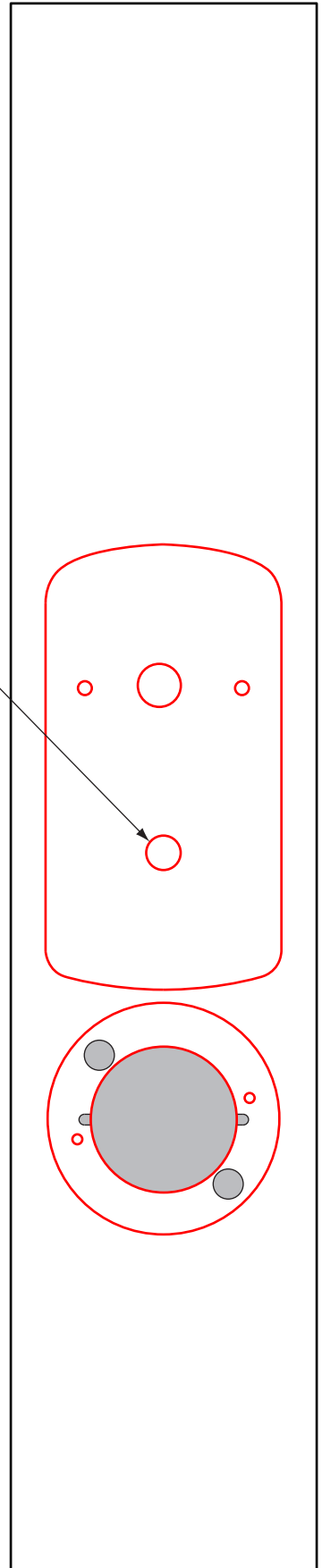



Inside Face of Door

Hole not required for CO-100-CY



# Sargent 7500

	<b>Retrofitting From:</b> Sargent 7500
	<b>To New Lock:</b> Schlage CO-100-CY Schlage CO-200-CY
	<b>Decorative Plates Required:</b> n/a

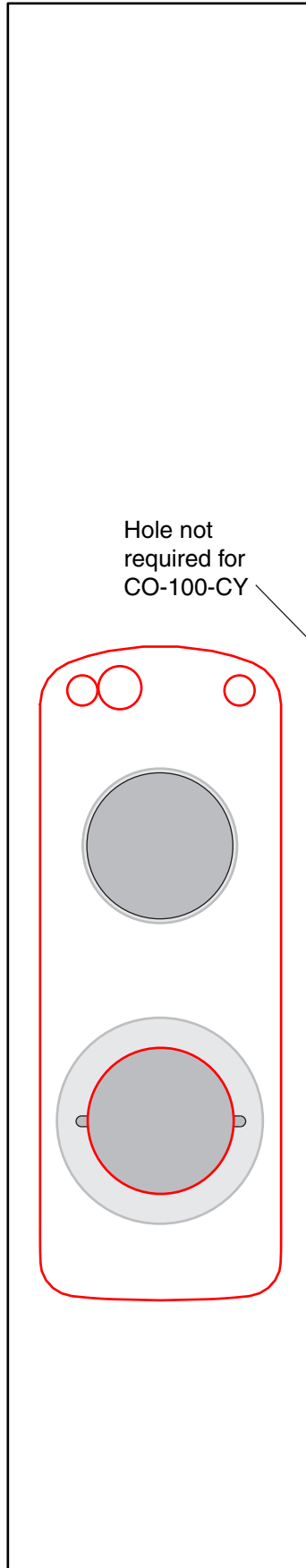

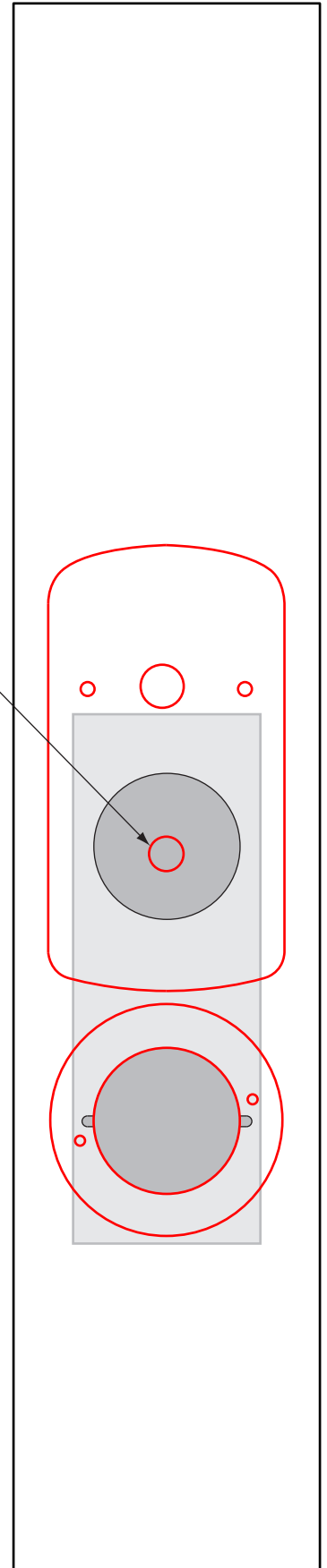

Outside Face of Door



Inside Face of Door

# Sargent DL-8-9

	<b>Retrofitting From:</b> Sargent DL-8-9
	<b>To New Lock:</b> Schlage CO-100-CY Schlage CO-200-CY
	<b>Decorative Plates Required:</b> n/a

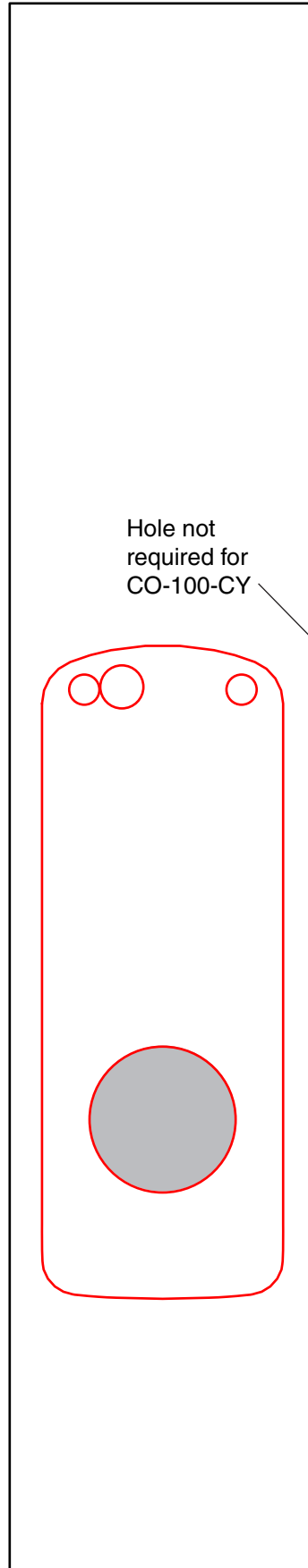

Outside Face of Door

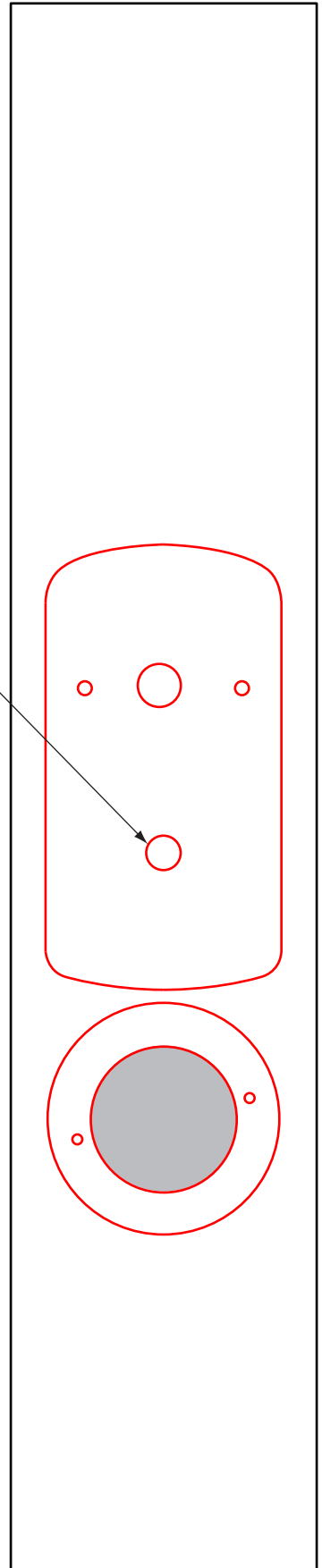





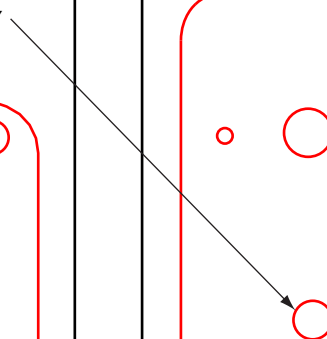

Inside Face of Door

Hole not required for CO-100-CY

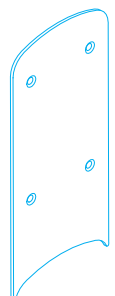

Sargent Profile 10G77

	<b>Retrofitting From:</b> Sargent Profile 10G77	
	<b>To New Lock:</b> Schlage CO-100-CY Schlage CO-200-CY	
<b>Decorative Plates Required</b>		
	<b>Surface Mounted Plate</b>	<b>Surface Mounted Plate + Under the Lock Plate</b>
		
	<b>Outside</b> <u>23760309</u>	<b>Inside</b> <u>23760267</u>
		 <u>23760275*</u>

\*A single under the lock plate will add 0.075" to the door thickness. CO Series Devices can be ordered for door thicknesses by increments of 0.125".

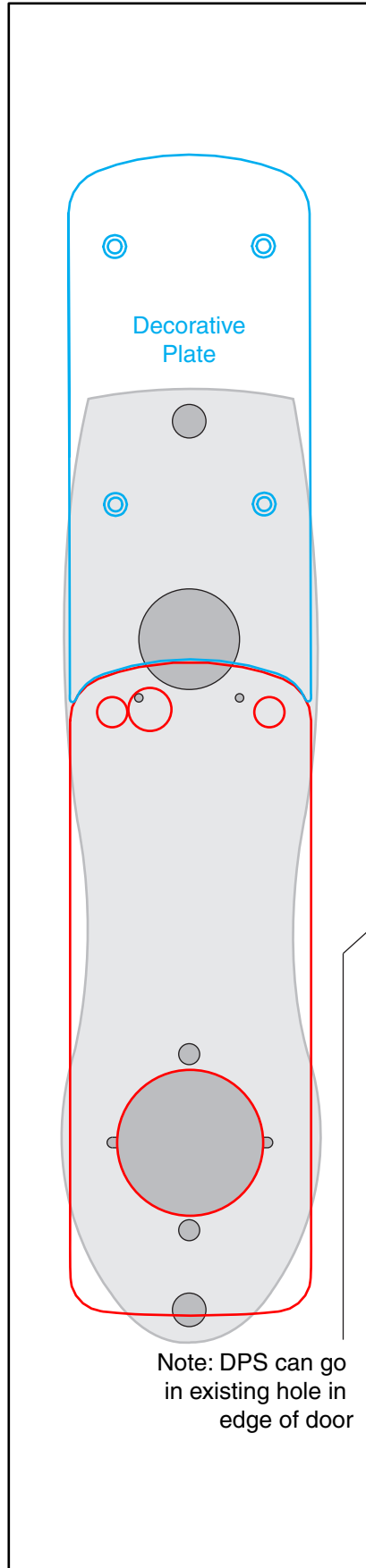

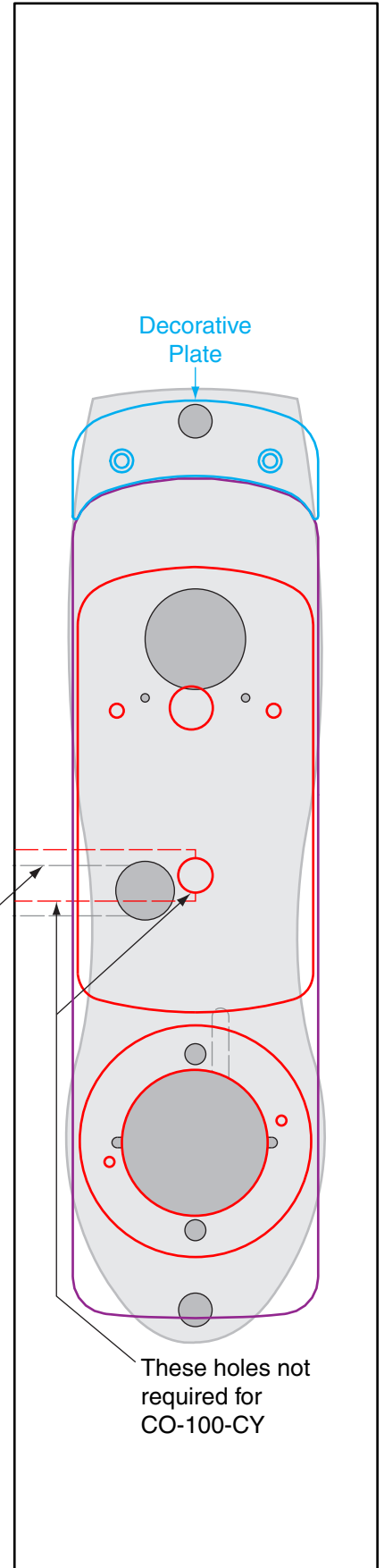

Outside Face of Door



Inside Face of Door

# Schlage AD-200/250/300/400-CY



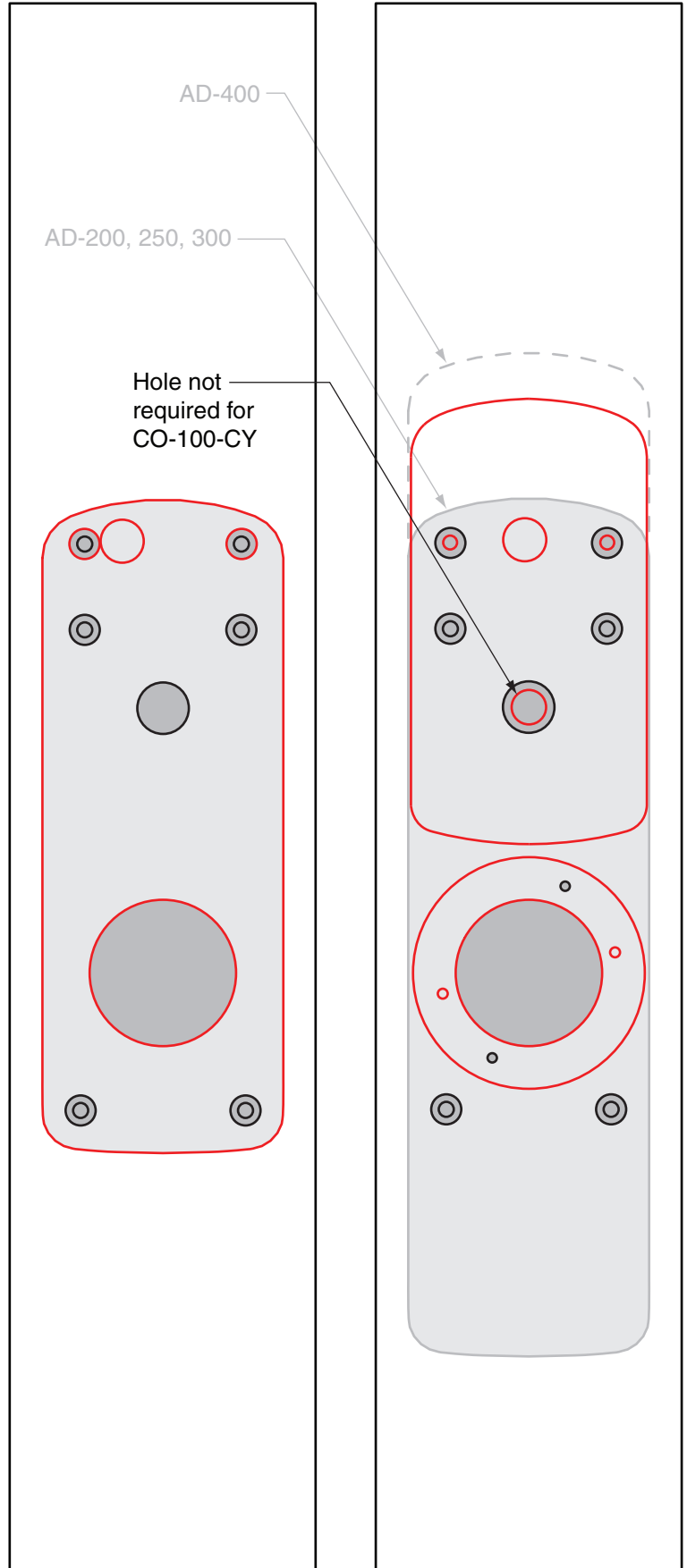

	<b>Retrofitting From:</b> Schlage AD-200/250/300/400-CY
	<b>To New Lock:</b> Schlage CO-100-CY Schlage CO-200-CY
	<b>Decorative Plates Required:</b> n/a



Outside Face of Door

Inside Face of Door

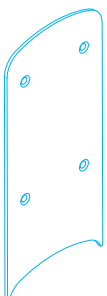
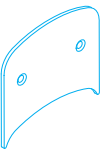
# Schlage CL5200-CM5200

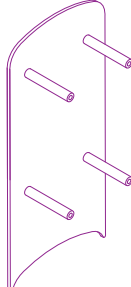
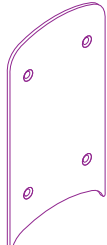
	<b>Retrofitting From:</b> Schlage CL5200-CM5200	
	<b>To New Lock:</b> Schlage CO-100-CY Schlage CO-200-CY	
<b>Decorative Plate Choices</b>		
	<b>Surface Mounted Plates</b>	
	<b>Outside</b> <u>23760309</u> 	<b>Inside</b> <u>23760283</u> 
-----OR-----		
	<b>Thru-Bolted Plates</b>	
	<b>Outside</b> <u>23760291</u> 	<b>Inside</b> <u>23760325</u> 

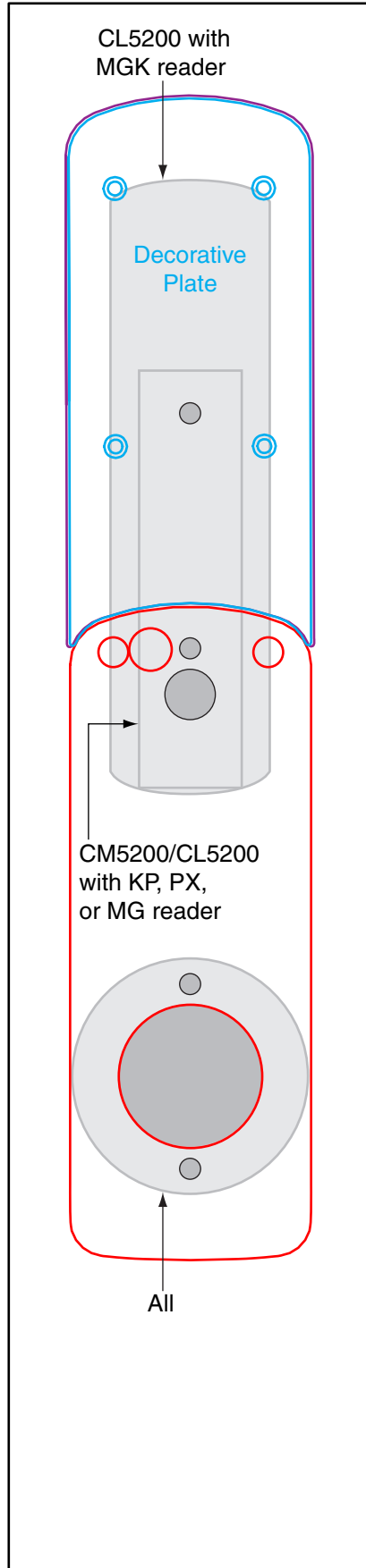



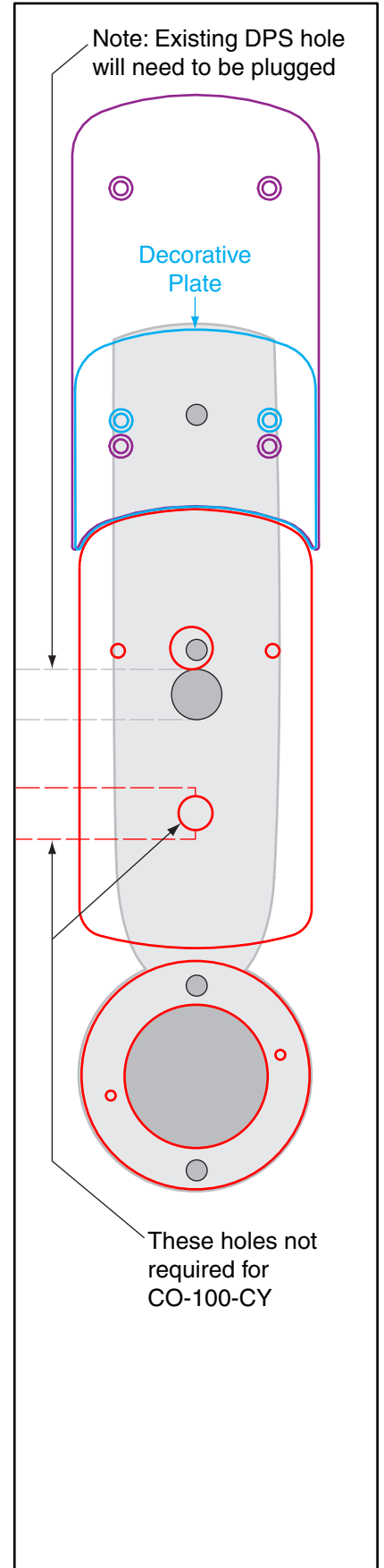

**Outside Face of Door**



**Inside Face of Door**

# Schlage CM5100-HW

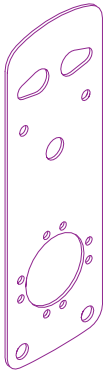
	<b>Retrofitting From:</b> Schlage CM5100-HW	
	<b>To New Lock:</b> Schlage CO-100-CY Schlage CO-200-CY	
<b>Decorative Plate Choices</b>		
	<b>Surface Mounted Plates</b>	
	<b>Outside</b> <u>23760267</u> 	<b>Inside</b> n/a
----- OR -----		
	<b>Under the Lock Plates</b>	
	<b>Outside</b> <u>23760259*</u> 	<b>Inside</b> n/a

\*A single under the lock plate will add 0.075" to the door thickness. CO Series Devices can be ordered for door thicknesses by increments of 0.125".

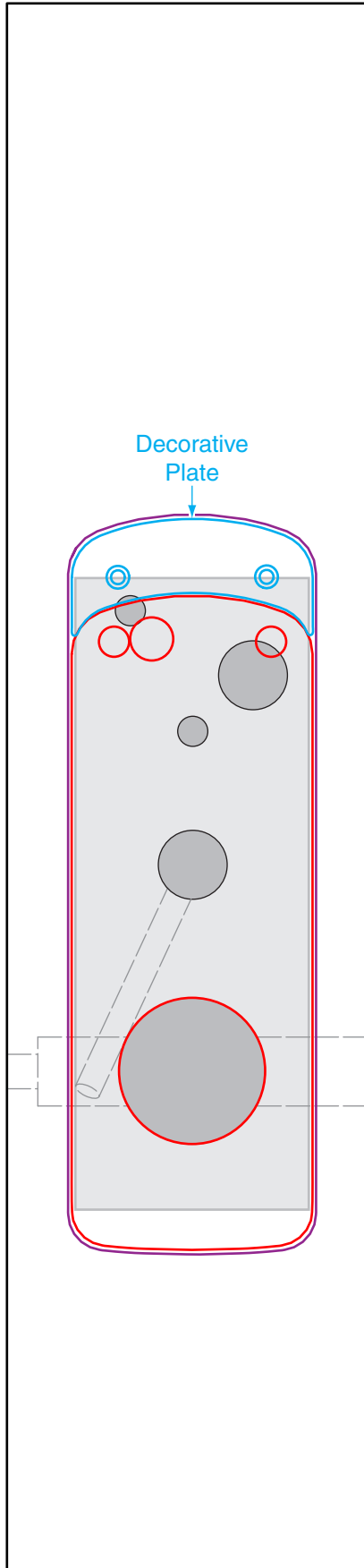

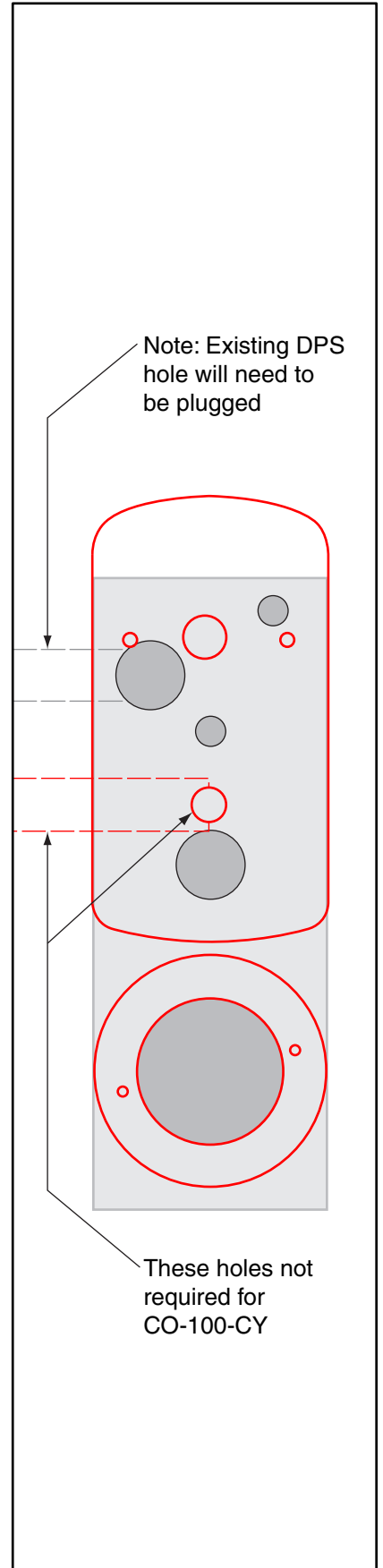

**Outside Face of Door**



**Inside Face of Door**

Schlage CM-CL-PRO-5100

	<b>Retrofitting From:</b> Schlage CM-CL-PRO-5100
	<b>To New Lock:</b> Schlage CO-100-CY Schlage CO-200-CY
	<b>Decorative Plates Required:</b> n/a

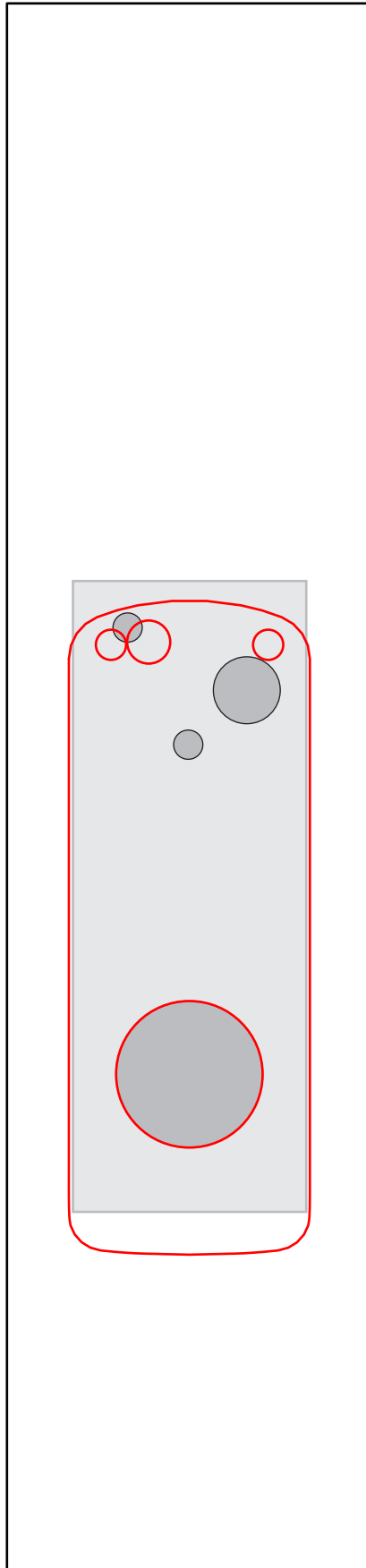

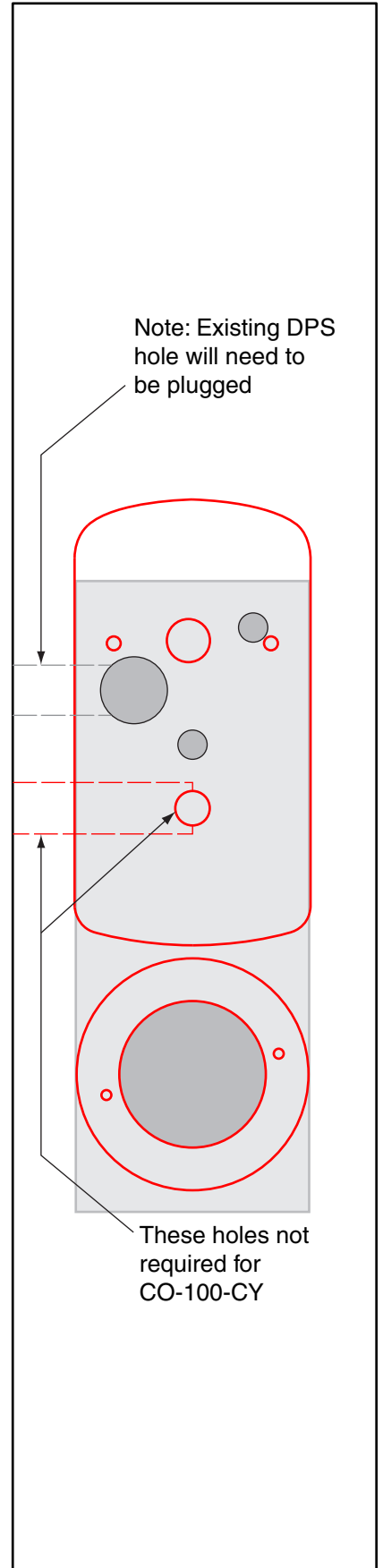

Outside Face of Door



Inside Face of Door

# Schlage KC5100

	<b>Retrofitting From:</b> Schlage KC5100
	<b>To New Lock:</b> Schlage CO-100-CY Schlage CO-200-CY
	<b>Decorative Plates Required:</b> n/a

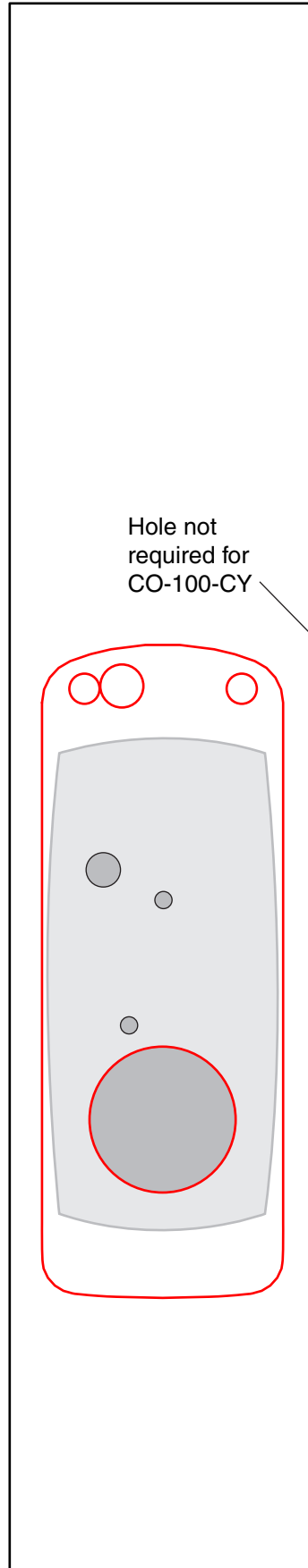

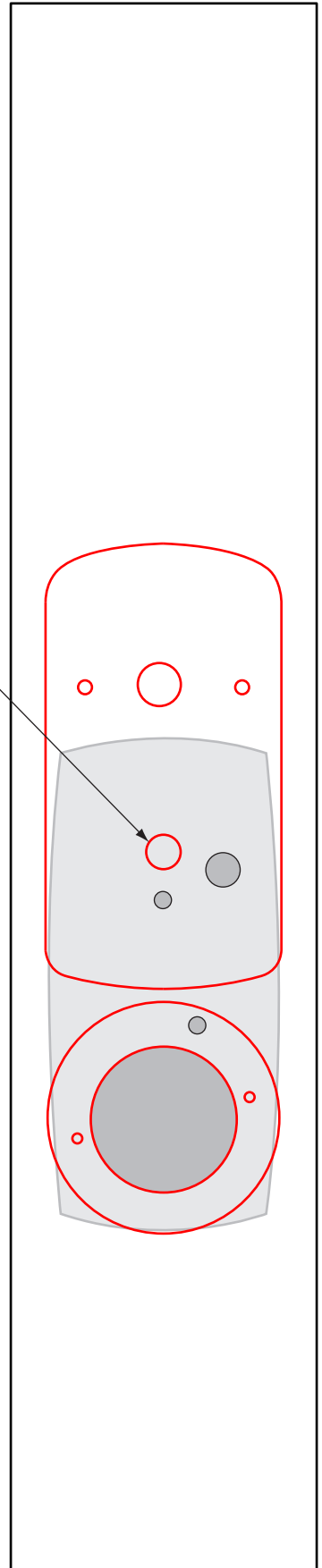

Outside Face of Door



Inside Face of Door



# Schlage ND Series

	<b>Retrofitting From:</b> Schlage ND Series
	<b>To New Lock:</b> Schlage CO-100-CY Schlage CO-200-CY
	<b>Decorative Plates Required:</b> n/a

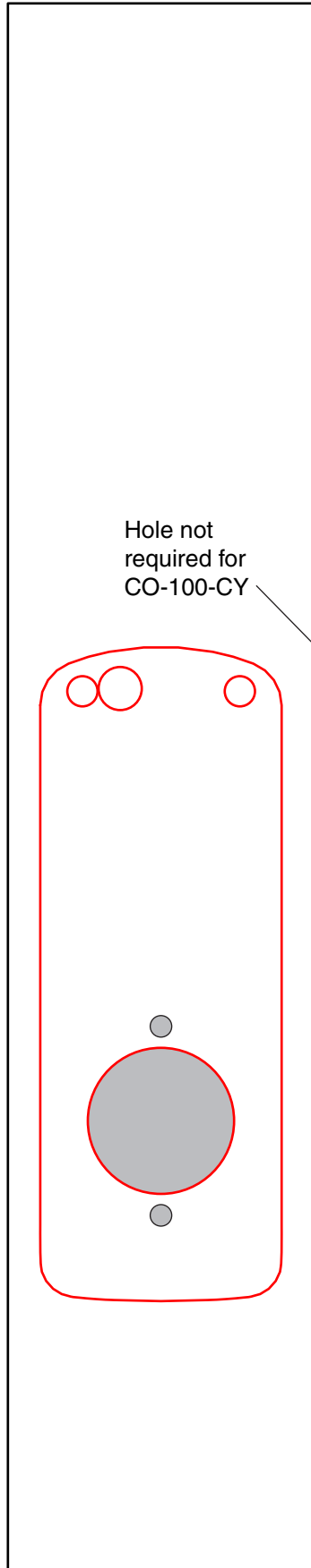



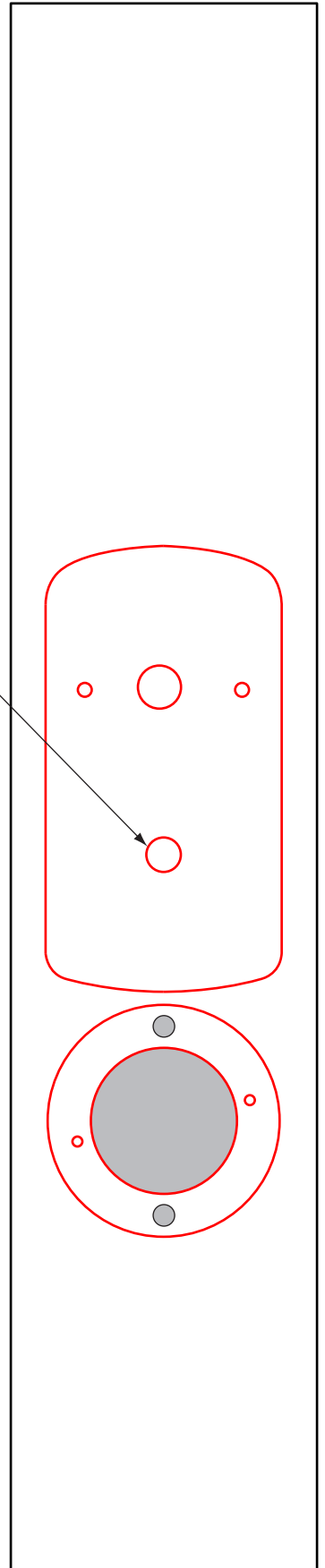

Outside Face of Door

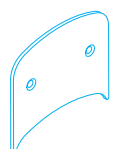
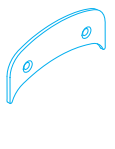

Inside Face of Door

# Schlage WA5200

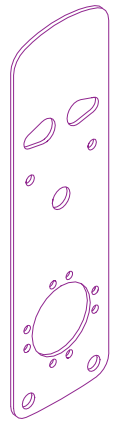
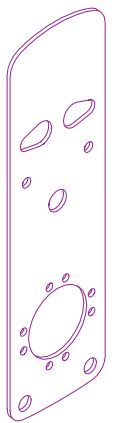
	<b>Retrofitting From:</b> Schlage WA5200	
	<b>To New Lock:</b> Schlage CO-100-CY Schlage CO-200-CY	
<b>Decorative Plate Choices</b>		
	<b>Surface Mounted Plates</b>	
	<b>Outside</b> <u>23760283</u> 	<b>Inside</b> <u>23760267</u> 
----- OR -----		
	<b>Under the Lock Plates</b>	
	<b>Outside</b> <u>23760275*</u> 	<b>Inside</b> <u>23760275*</u> 

\*A single under the lock plate will add 0.075" to the door thickness. CO Series Devices can be ordered for door thicknesses by increments of 0.125".

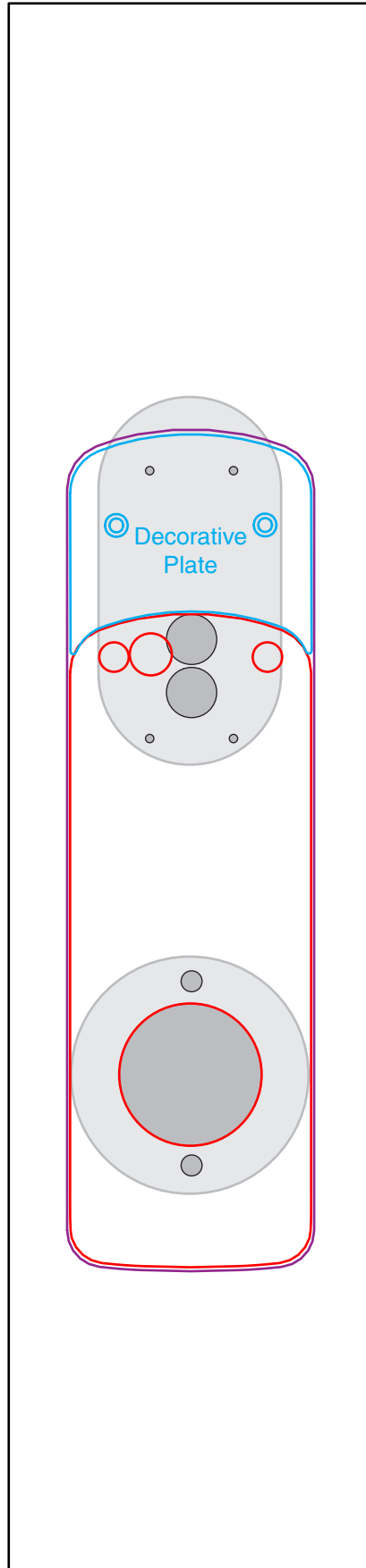



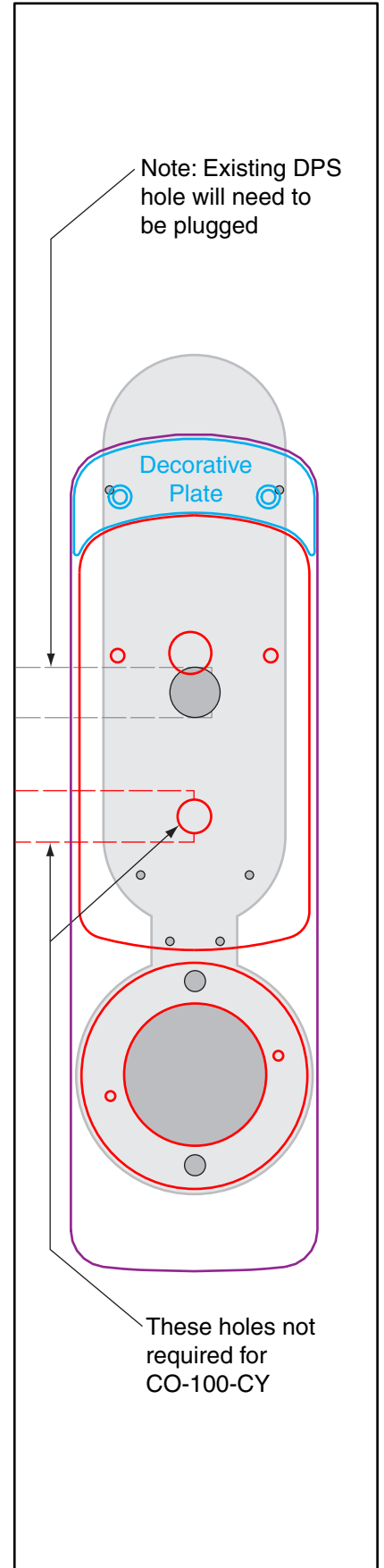

**Outside Face of Door**



**Inside Face of Door**

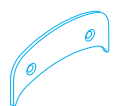

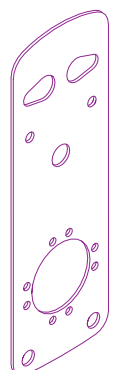

VIP 5100

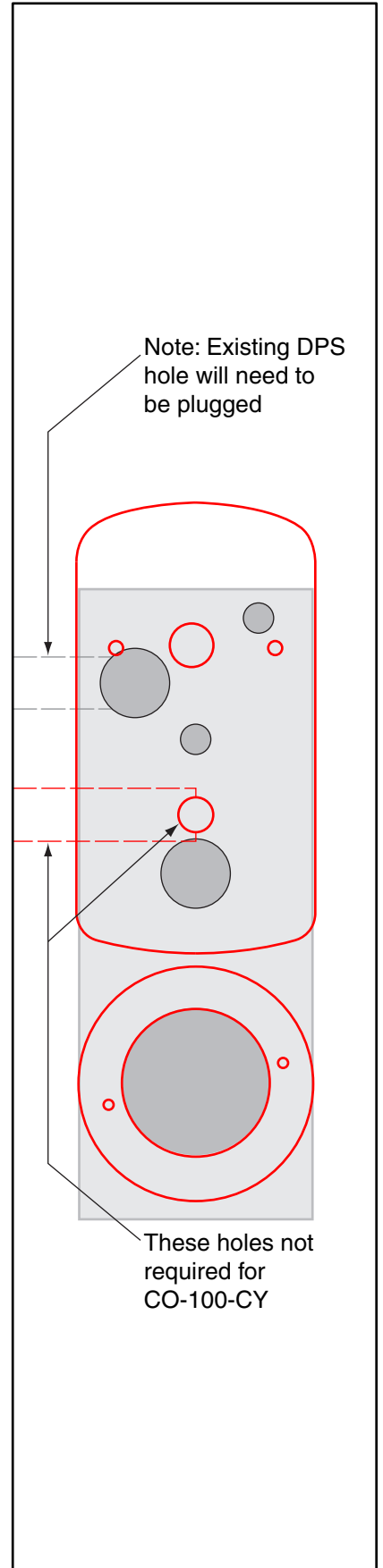
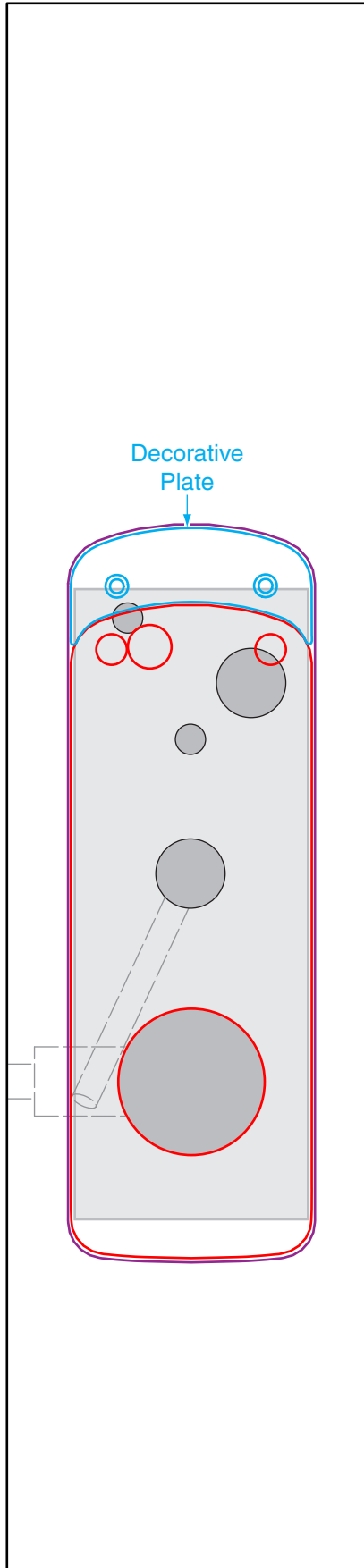
	<b>Retrofitting From:</b> VIP 5100	
	<b>To New Lock:</b> Schlage CO-100-CY Schlage CO-200-CY	
<b>Decorative Plate Choices</b>		
	<b>Surface Mounted Plates</b>	
	<b>Outside</b> <u>23760267</u> 	<b>Inside</b> n/a
----- OR -----		
	<b>Thru-Bolted / Under the Lock Plates</b>	
<b>Outside</b> <u>23760259*</u> 	<b>Inside</b> n/a	

\*A single under the lock plate will add 0.075" to the door thickness. CO Series Devices can be ordered for door thicknesses by increments of 0.125".

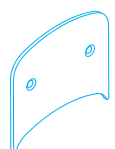

# Alarm Lock DL3500

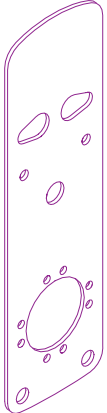
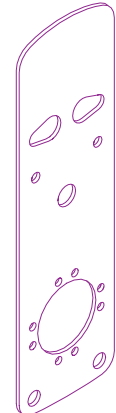
	<b>Retrofitting From:</b> Alarm Lock DL3500	
	<b>To New Lock:</b> Schlage CO-100-MS/MD Schlage CO-200-MS/MD	
<b>Decorative Plate Choices</b>		
<b>Surface Mounted Plates</b>		
	<b>Outside</b> <u>23760283</u> 	<b>Inside</b> <u>23760267</u> 
----- OR -----		
<b>Under the Lock Plates</b>		
	<b>Outside</b> <u>23760275*</u> 	<b>Inside</b> <u>23760275*</u> 

\*A single under the lock plate will add 0.075" to the door thickness. CO Series Devices can be ordered for door thicknesses by increments of 0.125".

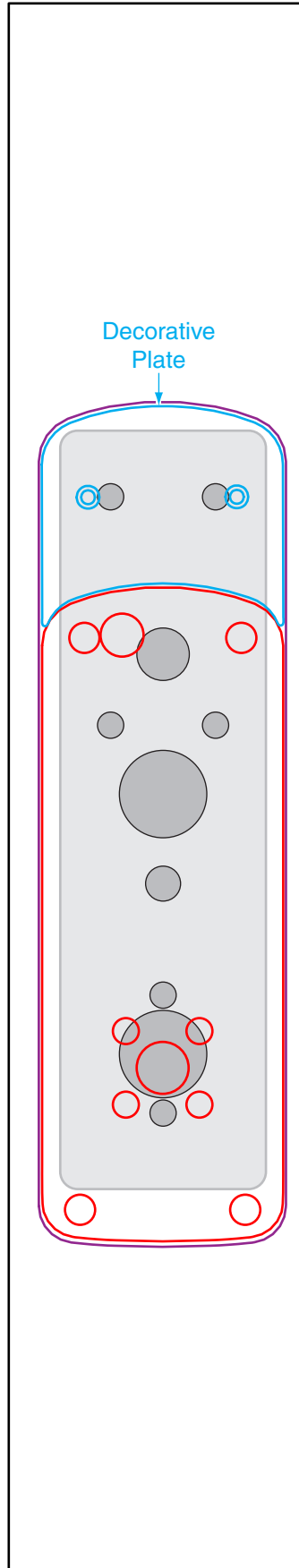

**Outside Face of Door**

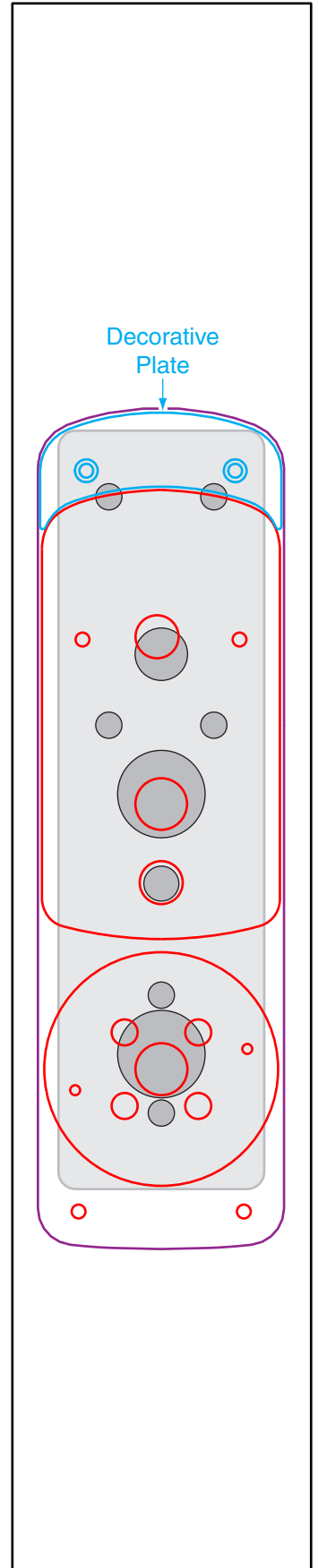

**Inside Face of Door**

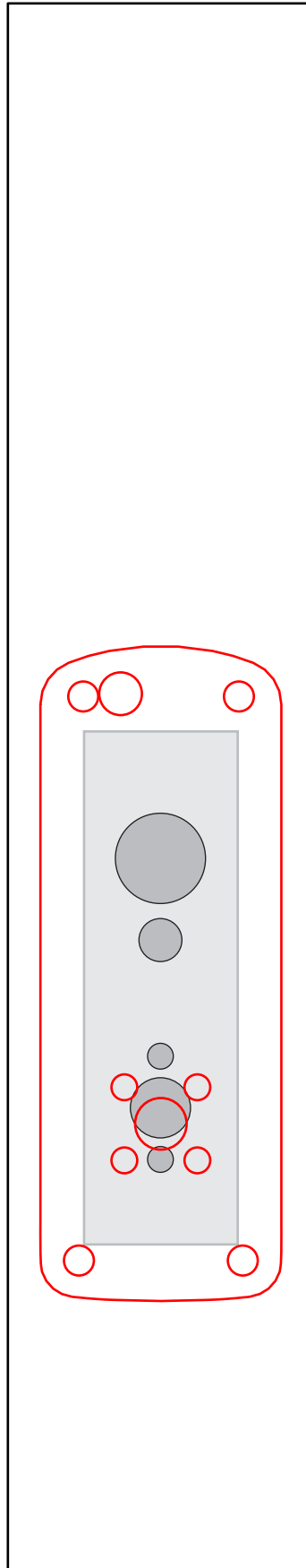

	<b>Retrofitting From:</b> Corbin ML2000
	<b>To New Lock:</b> Schlage CO-100-MS/MD Schlage CO-200-MS/MD
	<b>Decorative Plates Required:</b> n/a

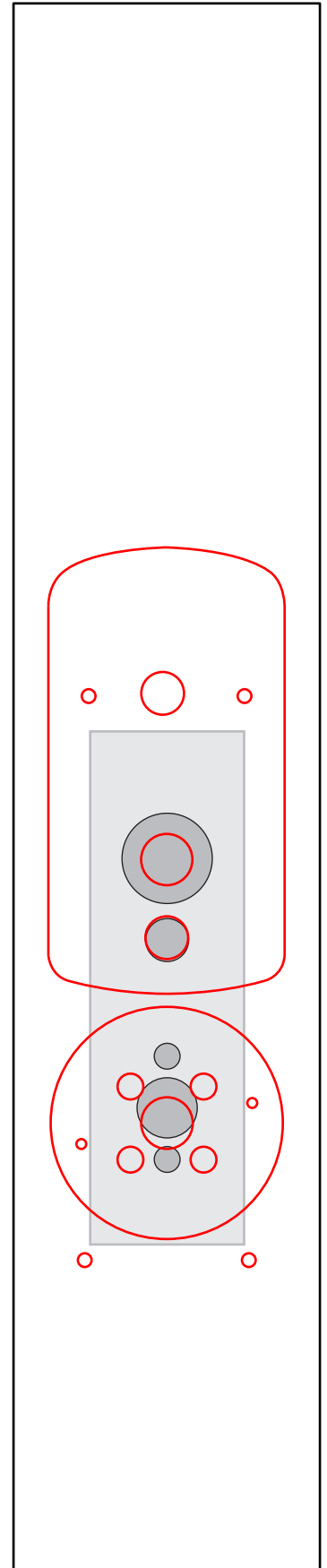

Outside Face of Door



Inside Face of Door

	<b>Retrofitting From:</b> Kaba E5700
	<b>To New Lock:</b> Schlage CO-100-MS/MD Schlage CO-200-MS/MD
	<b>Decorative Plates Required:</b> n/a

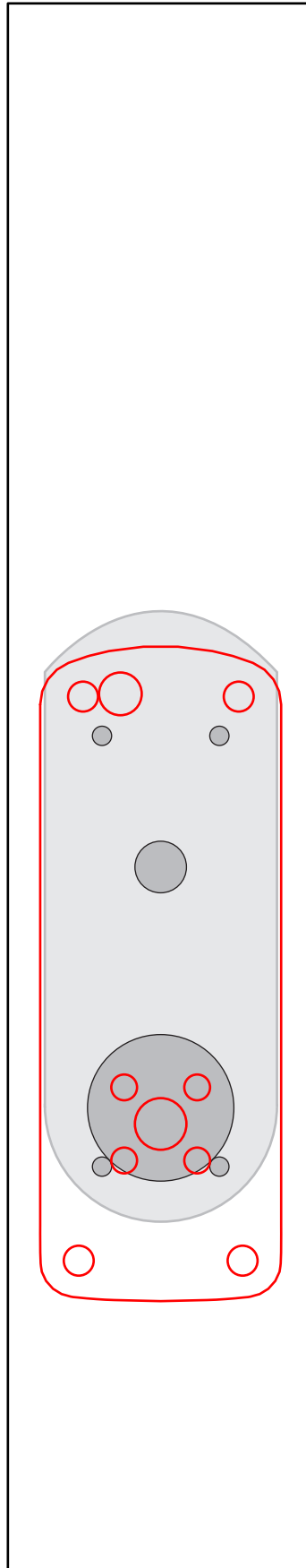

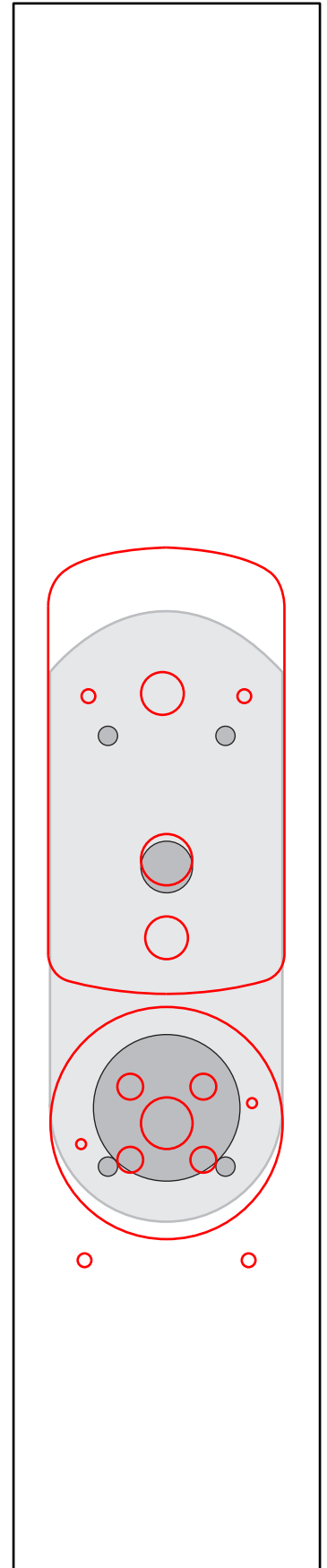

Outside Face of Door



Inside Face of Door

# Onity-HT



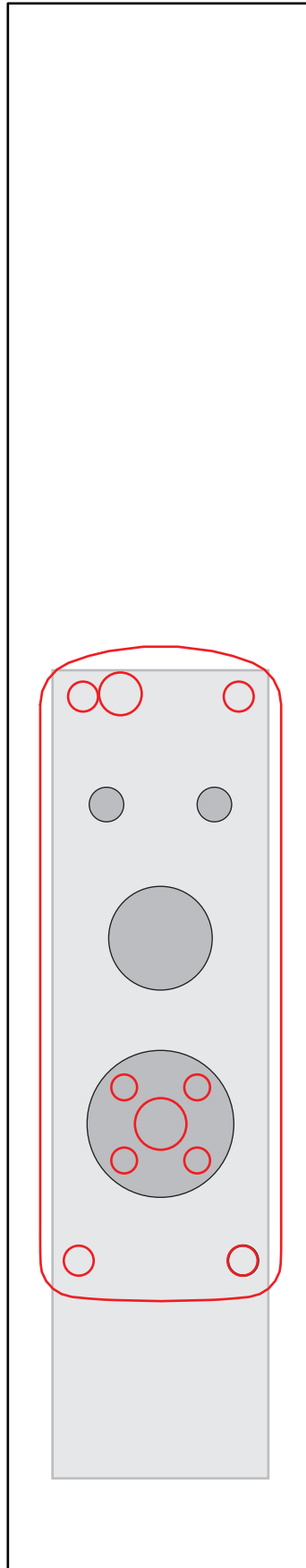

	<b>Retrofitting From:</b> Onity-HT
	<b>To New Lock:</b> Schlage CO-100-MS/MD Schlage CO-200-MS/MD
	<b>Decorative Plates Required:</b> n/a

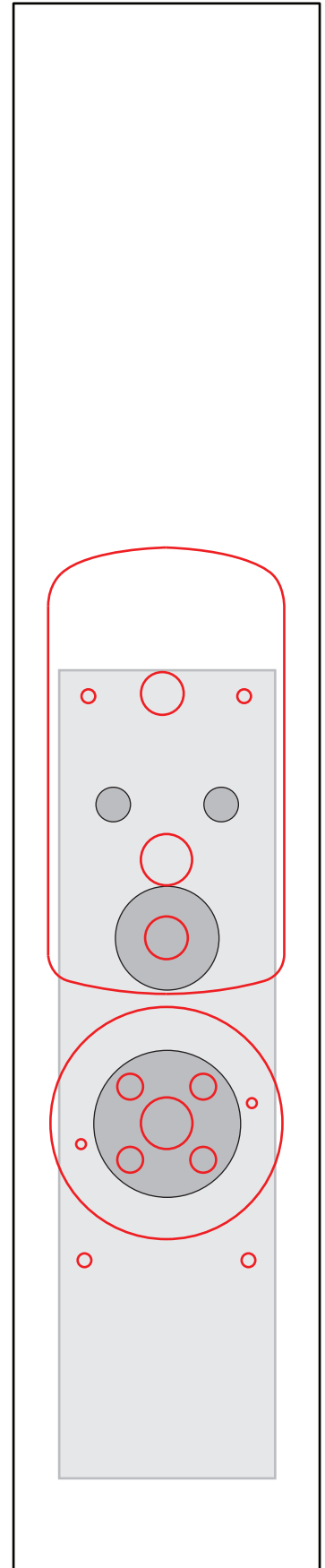

Outside Face of Door

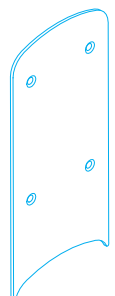
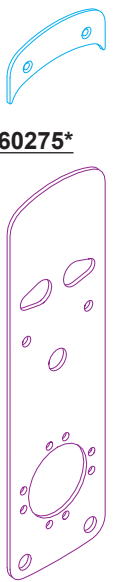

Inside Face of Door

	<b>Retrofitting From:</b> Persona 4000R / 5000R	
	<b>To New Lock:</b> Schlage CO-100-MS/MD Schlage CO-200-MS/MD	
<b>Decorative Plates Required</b>		
	<b>Surface Mounted Plate</b>	<b>Surface Mounted Plate</b>
		<b>+ Under the Lock Plate</b>
	<b>Outside</b> <u>23760309</u>	<b>Inside</b> <u>23760267</u>
		 <u>23760275*</u>

\*A single under the lock plate will add 0.075" to the door thickness. CO Series Devices can be ordered for door thicknesses by increments of 0.125".

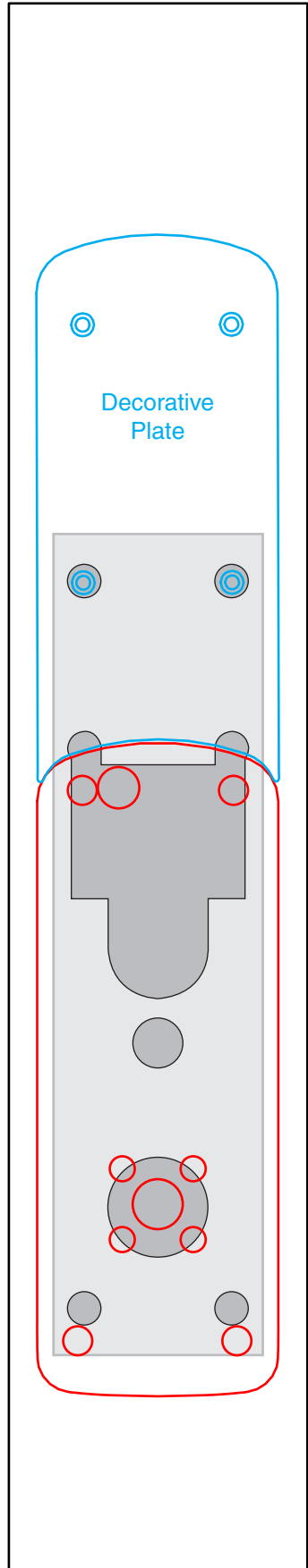

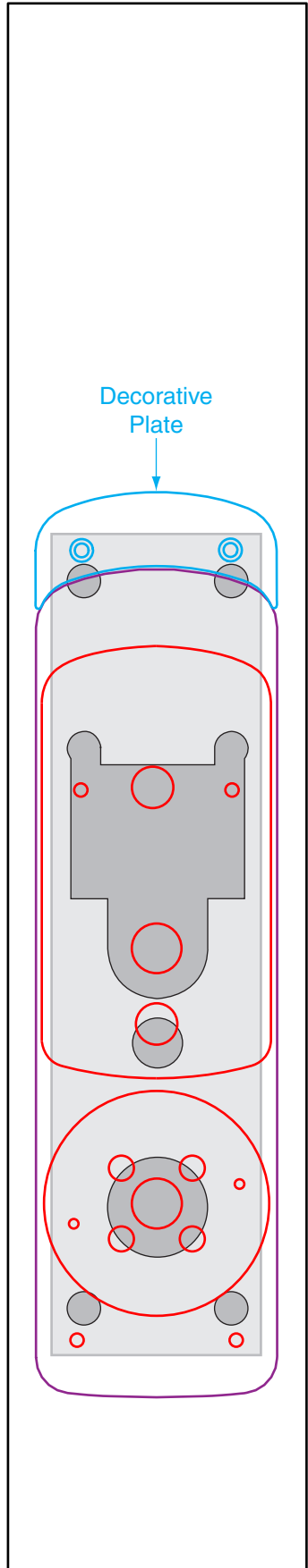

Outside Face of Door



Inside Face of Door



# Sargent 7900 Series Lock Body Only

	<b>Retrofitting From:</b> Sargent 7900 Series Lock Body Only
	<b>To New Lock:</b> Schlage CO-100-MS/MD Schlage CO-200-MS/MD
	<b>Decorative Plates Required:</b> n/a

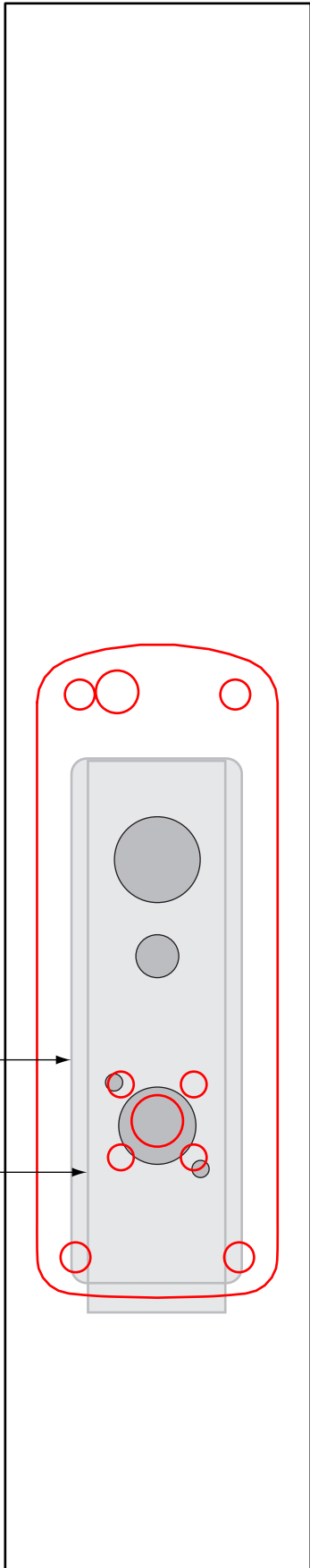



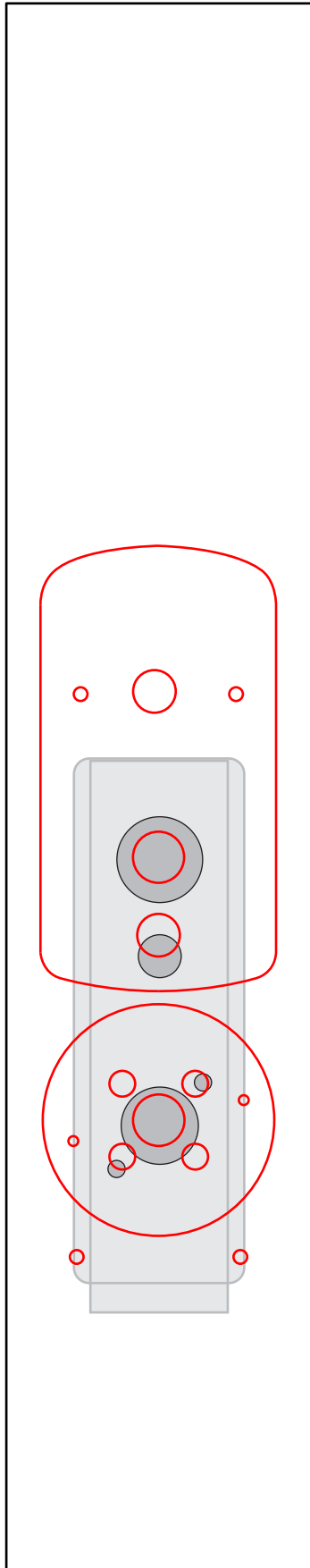

Outside Face of Door



Inside Face of Door

## Sargent Profile Series Mortise

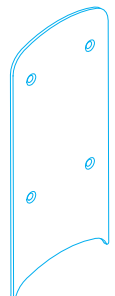
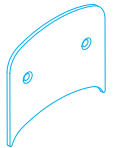
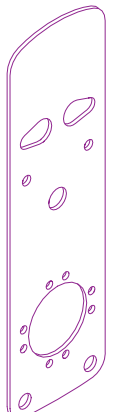
	<b>Retrofitting From:</b> Sargent Profile Series Mortise	
	<b>To New Lock:</b> Schlage CO-100-MS/MD Schlage CO-200-MS/MD	
<b>Decorative Plates Required</b>		
	<b>Surface Mounted Plate</b>	<b>Surface Mounted Plate</b>
		+
		<b>Under the Lock Plate</b>
	<b>Outside</b> <u>23760309</u>	<b>Inside</b> <u>23760283</u>
		  

\*A single under the lock plate will add 0.075" to the door thickness. CO Series Devices can be ordered for door thicknesses by increments of 0.125".

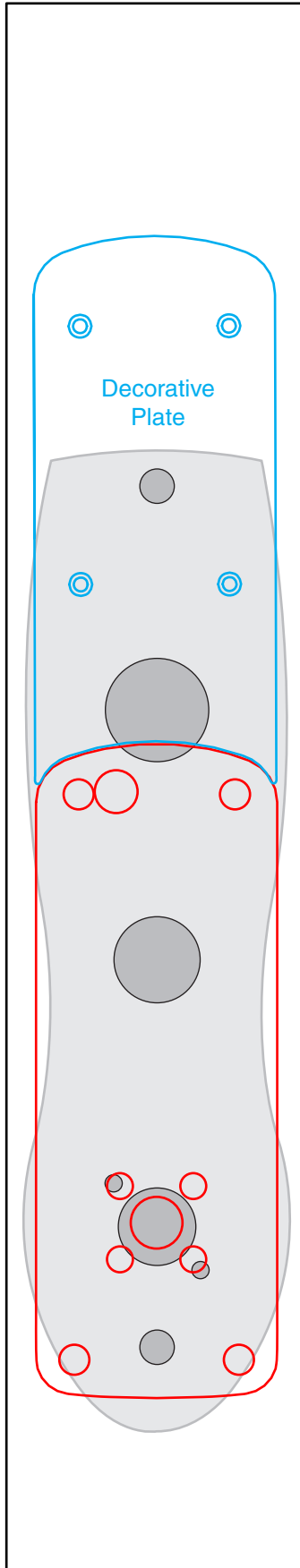

**Outside Face of Door**

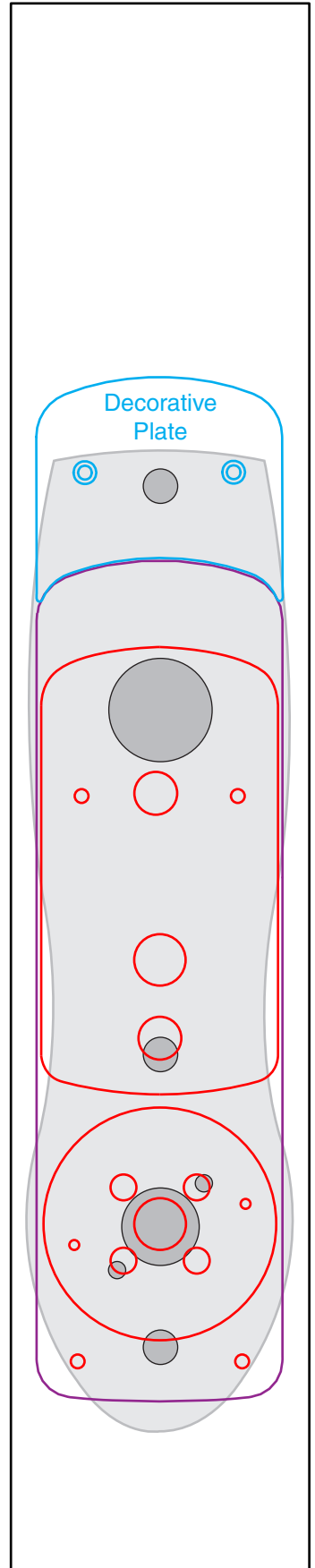

**Inside Face of Door**

Schlage AD200/250/300/400-MS/MD



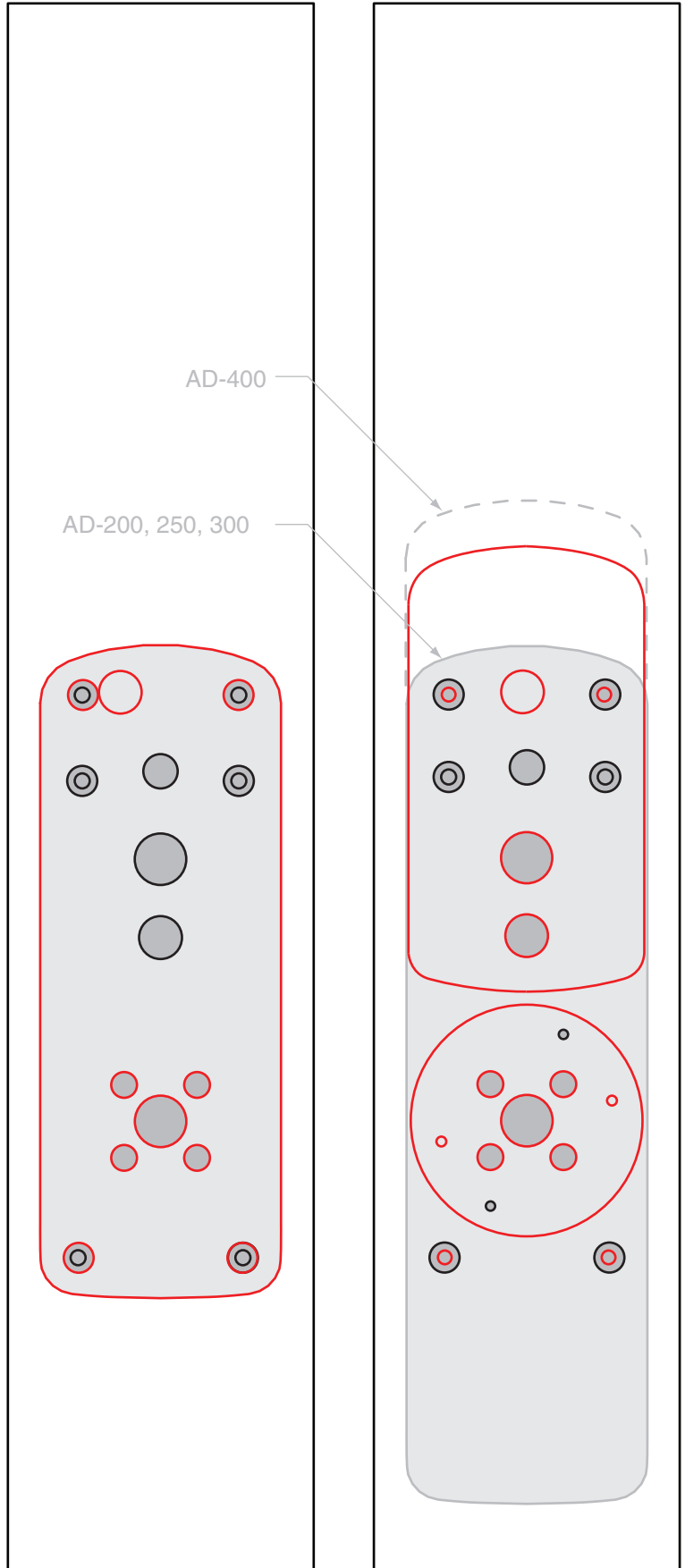

	<b>Retrofitting From:</b> Schlage AD200/250/300/400-MS/MD
	<b>To New Lock:</b> Schlage CO-100-MS/MD Schlage CO-200-MS/MD
	<b>Decorative Plates Required:</b> n/a



Outside Face of Door

Inside Face of Door

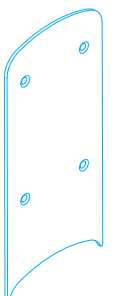
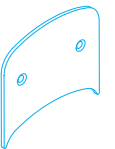
# Schlage CM5600

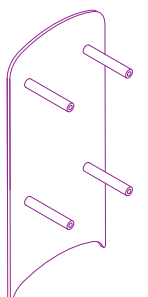
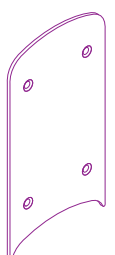

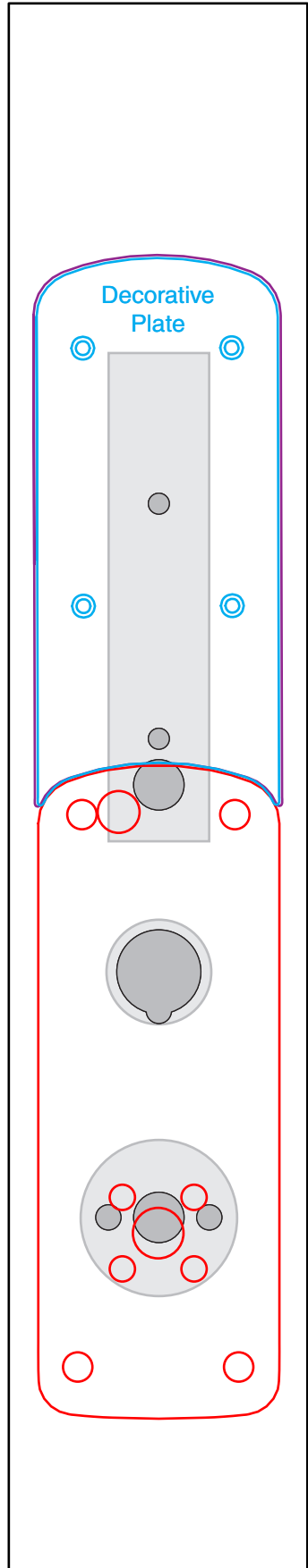

	<b>Retrofitting From:</b> Schlage CM5600	
	<b>To New Lock:</b> Schlage CO-100-MS/MD Schlage CO-200-MS/MD	
<b>Decorative Plate Choices</b>		
	<b>Surface Mounted Plates</b>	
	<b>Outside</b> <u>23760309</u> 	<b>Inside</b> <u>23760283</u> 
-----OR-----		
	<b>Thru-Bolted Plates</b>	
	<b>Outside</b> <u>23760291</u> 	<b>Inside</b> <u>23760325</u> 

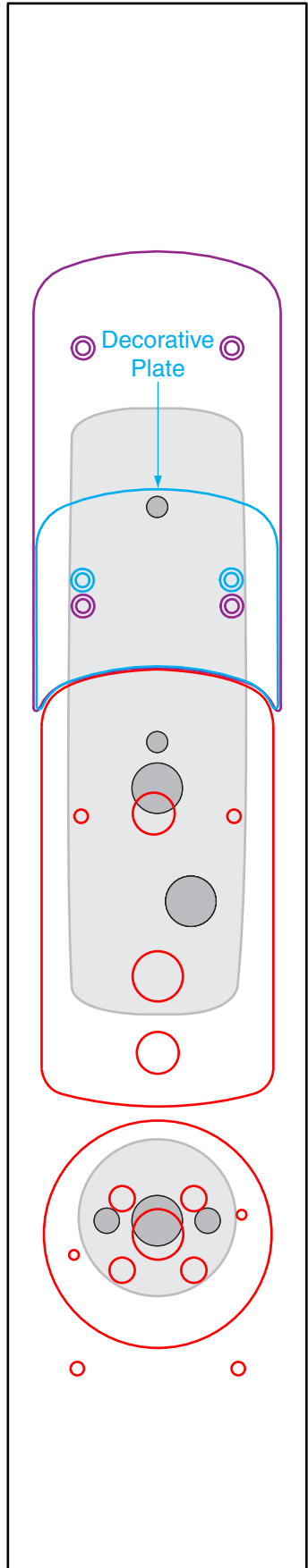

**Outside Face of Door**

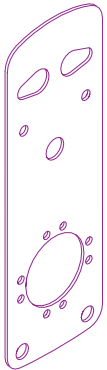

**Inside Face of Door**

	<b>Retrofitting From:</b> Schlage CM-CL-PRO-5500	
	<b>To New Lock:</b> Schlage CO-100-MS/MD Schlage CO-200-MS/MD	
<b>Decorative Plate Choices</b>		
	<b>Surface Mounted Plates</b>	
	<b>Outside</b> <u>23760267</u> 	<b>Inside</b> n/a
----- OR -----		
	<b>Under the Lock Plates</b>	
	<b>Outside</b> <u>23760259*</u> 	<b>Inside</b> n/a

\*A single under the lock plate will add 0.075" to the door thickness. CO Series Devices can be ordered for door thicknesses by increments of 0.125".

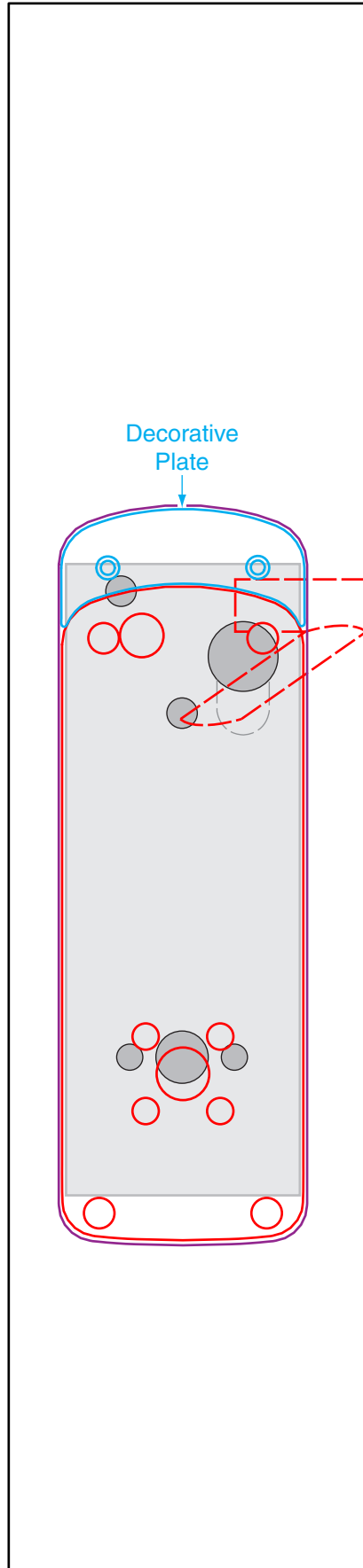

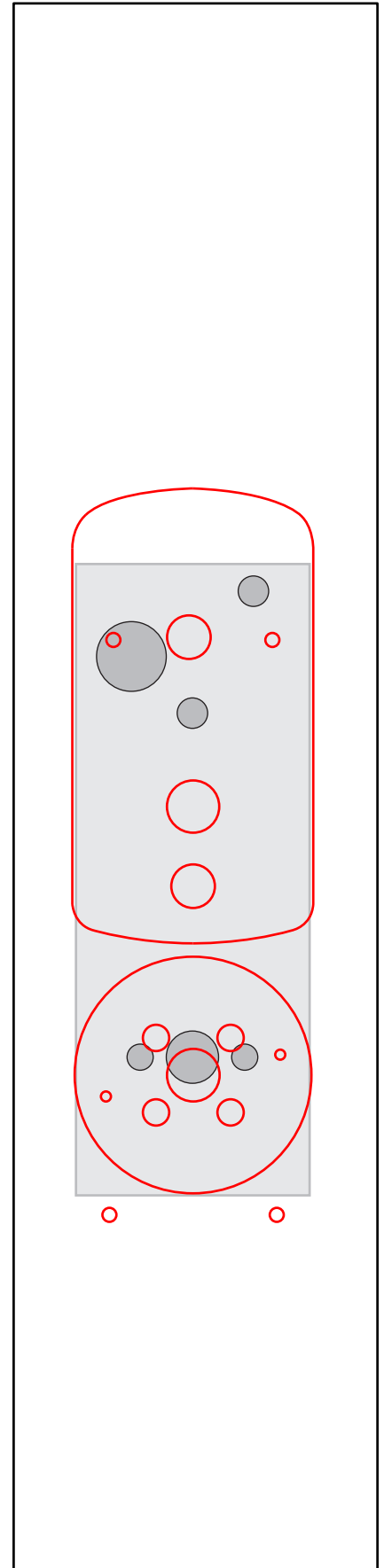

Outside Face of Door



Inside Face of Door

# Schlage KC5500

	<b>Retrofitting From:</b> Schlage KC5500
	<b>To New Lock:</b> Schlage CO-100-MS/MD Schlage CO-200-MS/MD
	<b>Decorative Plates Required:</b> n/a

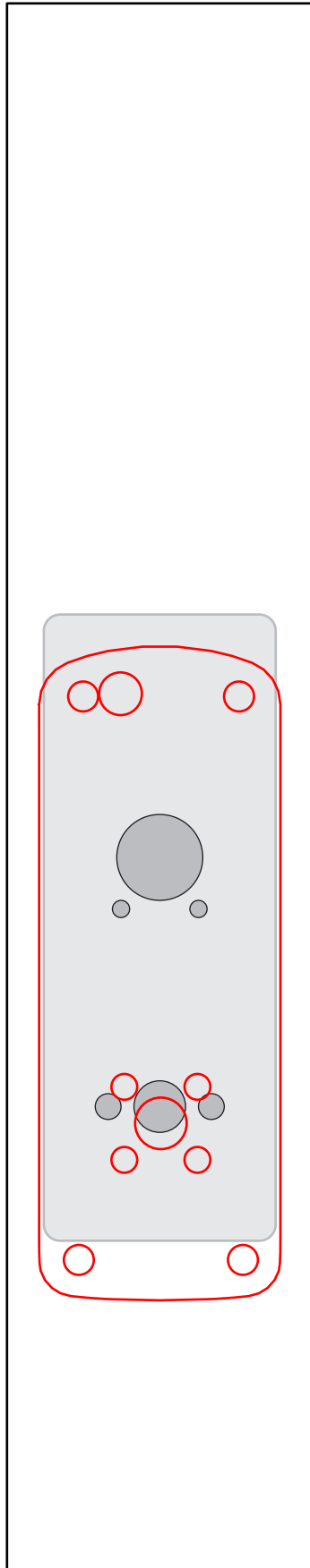



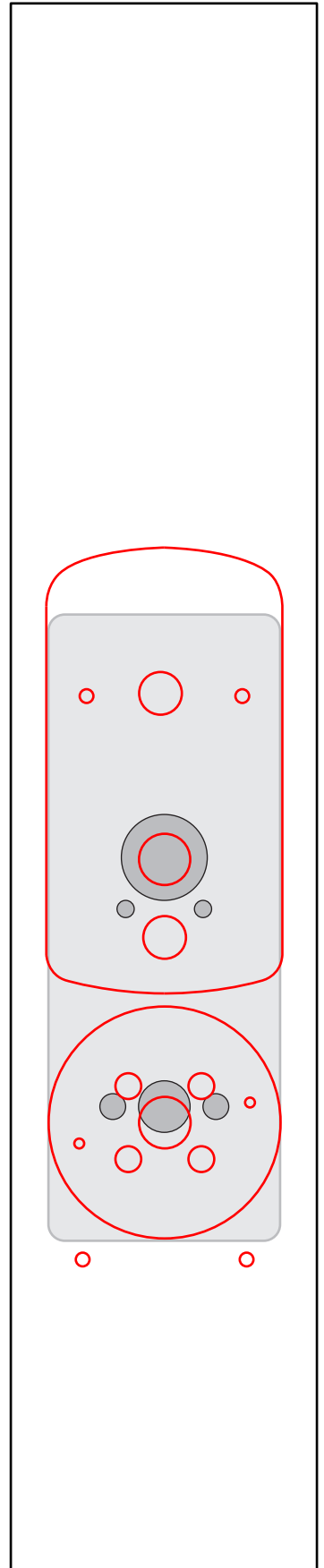

Outside Face of Door



Inside Face of Door

# Schlage L/LV-9486

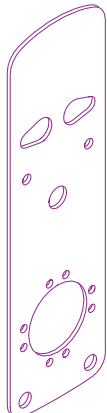
	<b>Retrofitting From:</b> Schlage L/LV-9486	
	<b>To New Lock:</b> Schlage CO-100-MS/MD Schlage CO-200-MS/MD	
<b>Decorative Plate Choices</b>		
	<b>Surface Mounted Plates</b>	
	<b>Outside</b> n/a	<b>Inside</b> n/a
----- <b>OR</b> -----		
	<b>Under the Lock Plates</b>	
	<b>Outside</b> n/a	<b>Inside</b> <u><b>23760275*</b></u> 

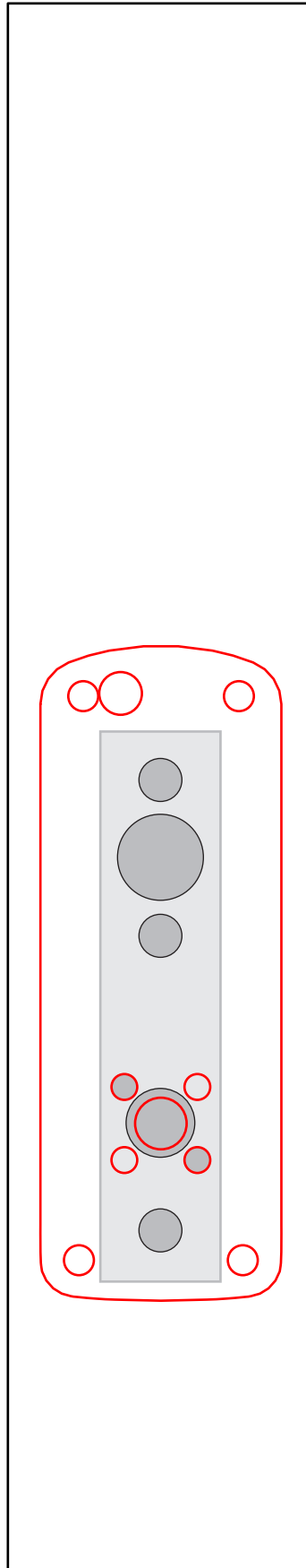

\*A single under the lock plate will add 0.075" to the door thickness. CO Series Devices can be ordered for door thicknesses by increments of 0.125".

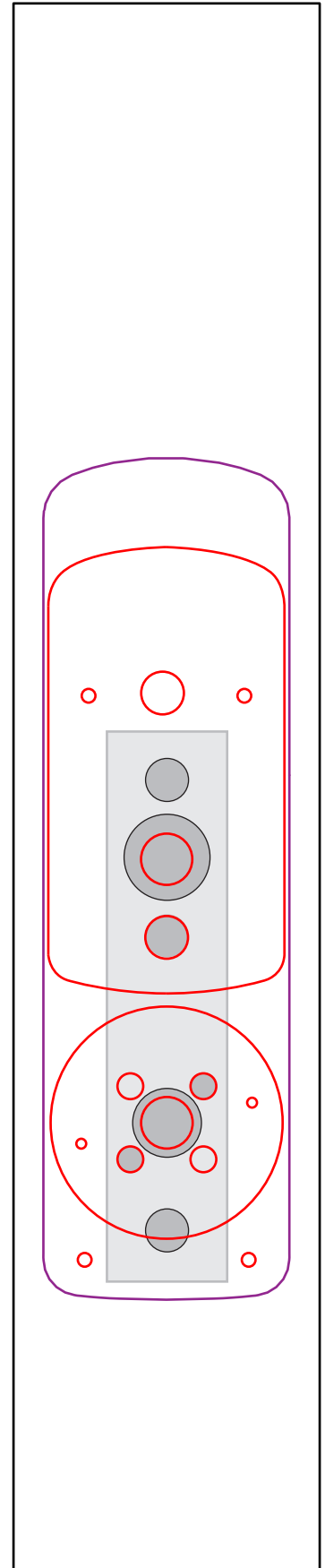

**Outside Face of Door**



**Inside Face of Door**

	<b>Retrofitting From:</b> Schlage MPM / 5500
	<b>To New Lock:</b> Schlage CO-100-MS/MD Schlage CO-200-MS/MD
	<b>Decorative Plates Required:</b> n/a

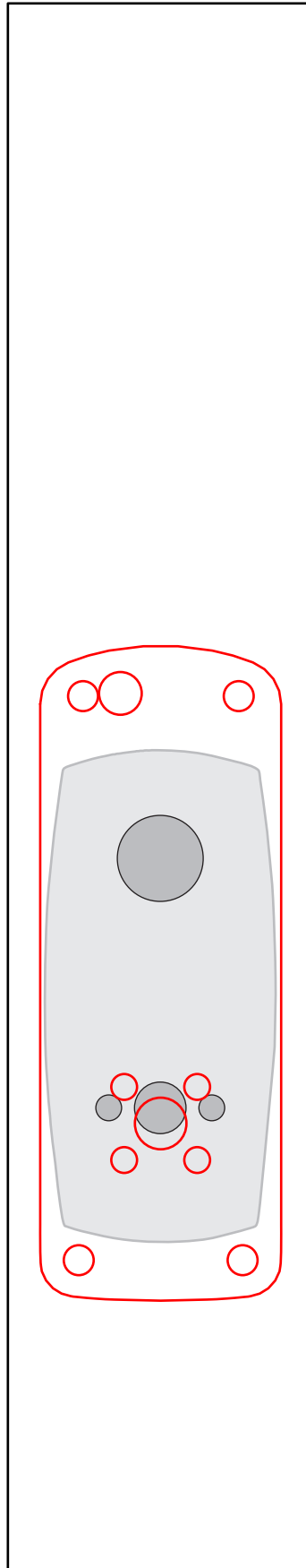



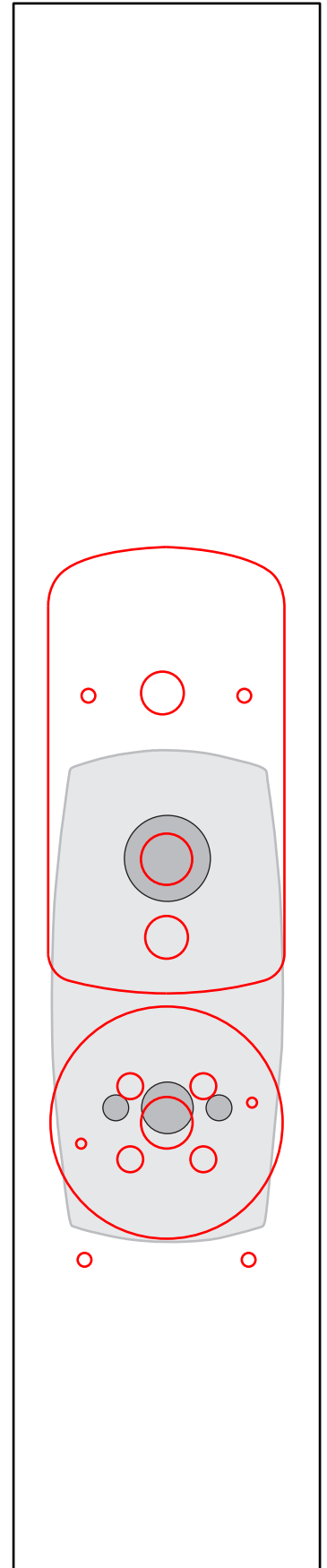

Outside Face of Door



Inside Face of Door

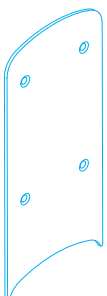
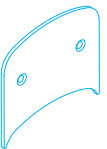

# Schlage WA5600

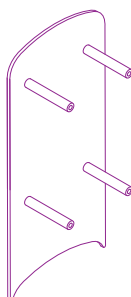
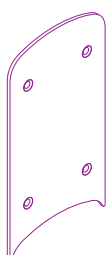

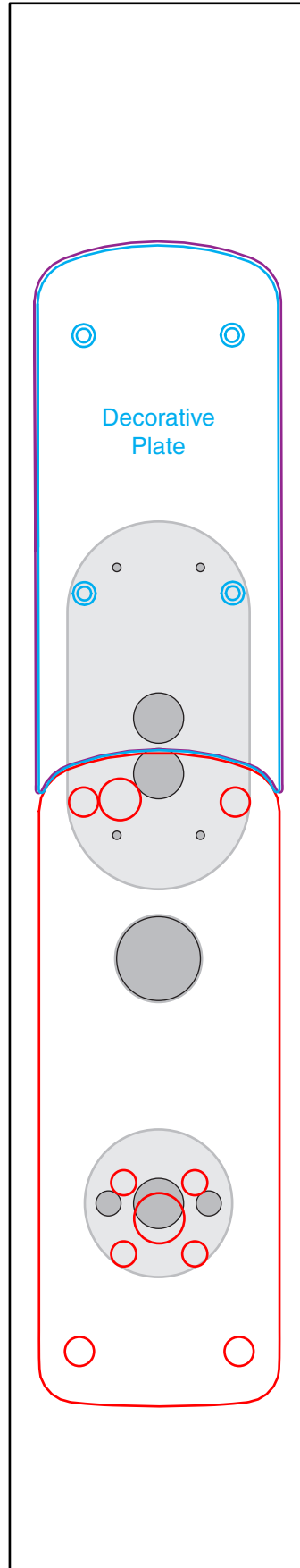

	<b>Retrofitting From:</b> Schlage WA5600	
	<b>To New Lock:</b> Schlage CO-100-MS/MD Schlage CO-200-MS/MD	
<b>Decorative Plate Choices</b>		
<b>Surface Mounted Plates</b>		
	<b>Outside</b> <b><u>23760309</u></b> 	<b>Inside</b> <b><u>23760283</u></b> 
-----OR-----		
<b>Thru-Bolted Plates</b>		
	<b>Outside</b> <b><u>23760291</u></b> 	<b>Inside</b> <b><u>23760325</u></b> 

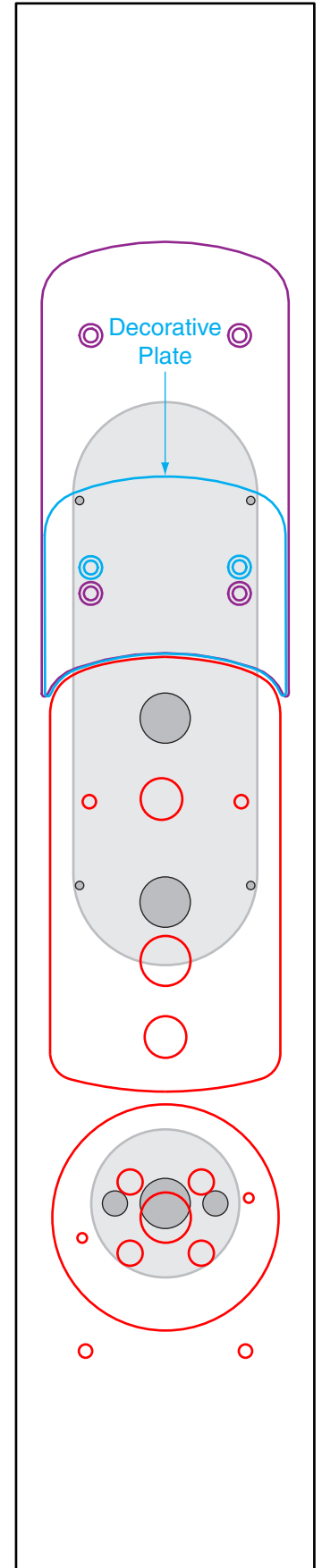

**Outside Face of Door**

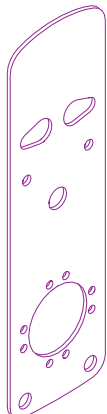

**Inside Face of Door**

	<b>Retrofitting From:</b> Stanley 45H / HW-47H / HW-IDH	
	<b>To New Lock:</b> Schlage CO-100-MS/MD Schlage CO-200-MS/MD	
<b>Decorative Plate Choices</b>		
	<b>Surface Mounted Plates</b>	
	<b>Outside</b> n/a	<b>Inside</b> n/a
----- OR -----		
	<b>Under the Lock Plates</b>	
	<b>Outside</b> n/a	<b>Inside</b> <u>23760275*</u>
		

\*A single under the lock plate will add 0.075" to the door thickness. CO Series Devices can be ordered for door thicknesses by increments of 0.125".

Note: Existing DPS hole will need to be plugged

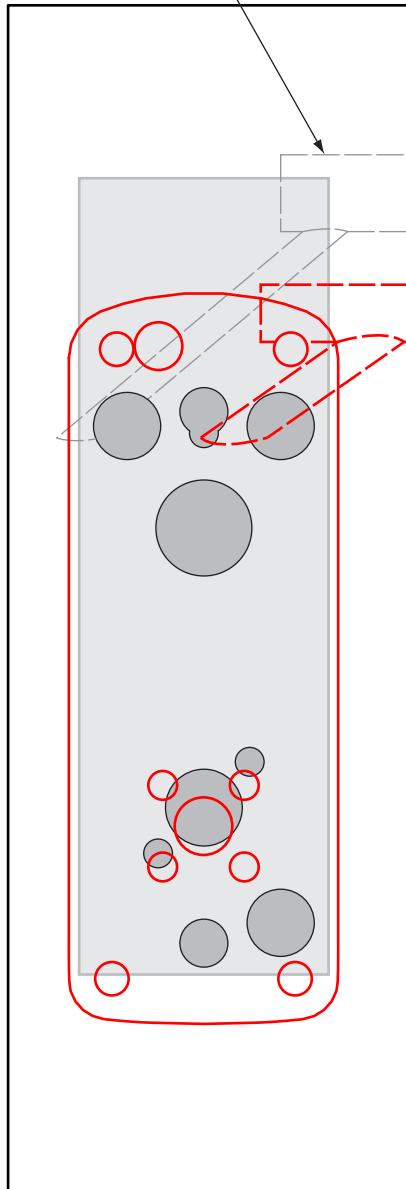



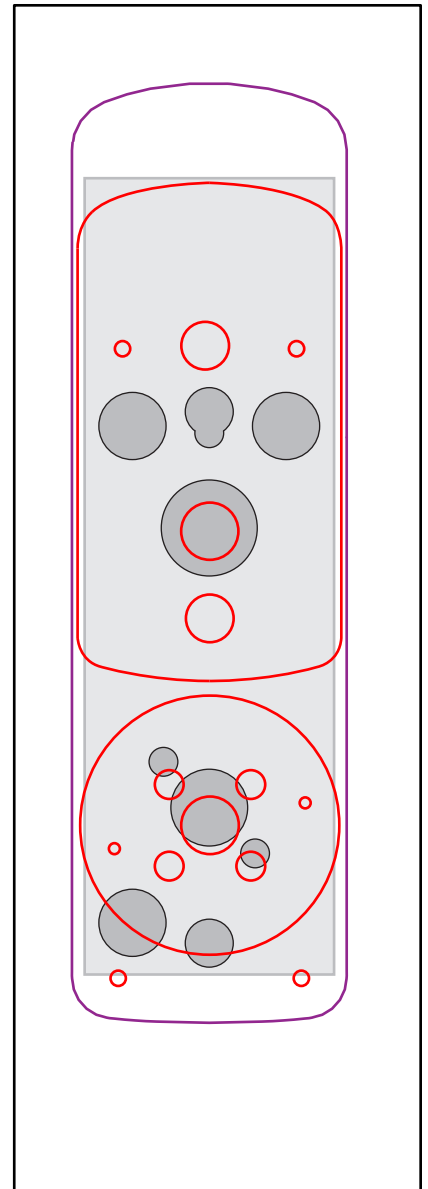

Outside Face of Door



Inside Face of Door

Best Exit Trim (on Von Duprin 98/99 Rim)

	<b>Retrofitting From:</b> Best Exit Trim (on Von Duprin 98/99 Rim)	
	<b>To New Lock:</b> Schlage CO-100-993 Schlage CO-200-993	
<b>Decorative Plate Choices</b>		
	<b>Surface Mounted Exit Plate</b>	
	<b>Outside</b> n/a	<b>Inside</b> <b>23631823</b> 
-----OR-----		
	<b>Thru-Bolted / Under the Lock Plates</b>	
	<b>Outside</b> n/a	<b>Inside</b> n/a

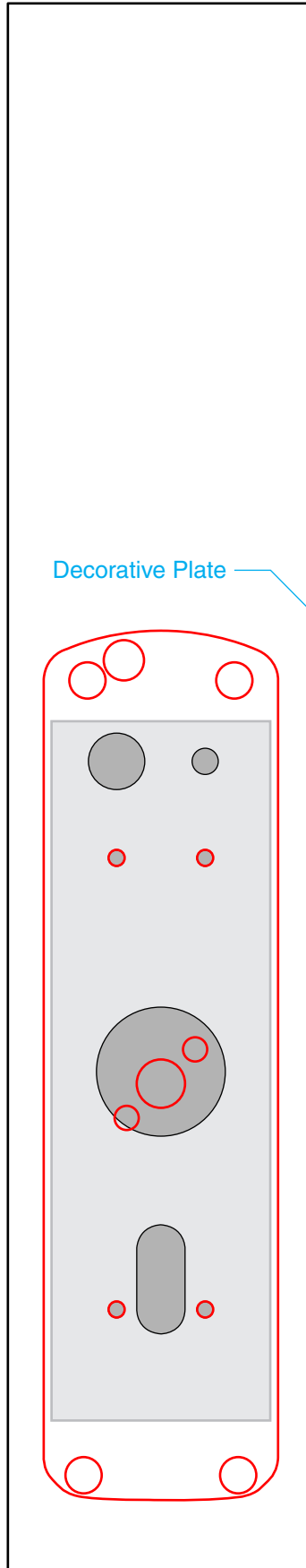

Outside Face of Door

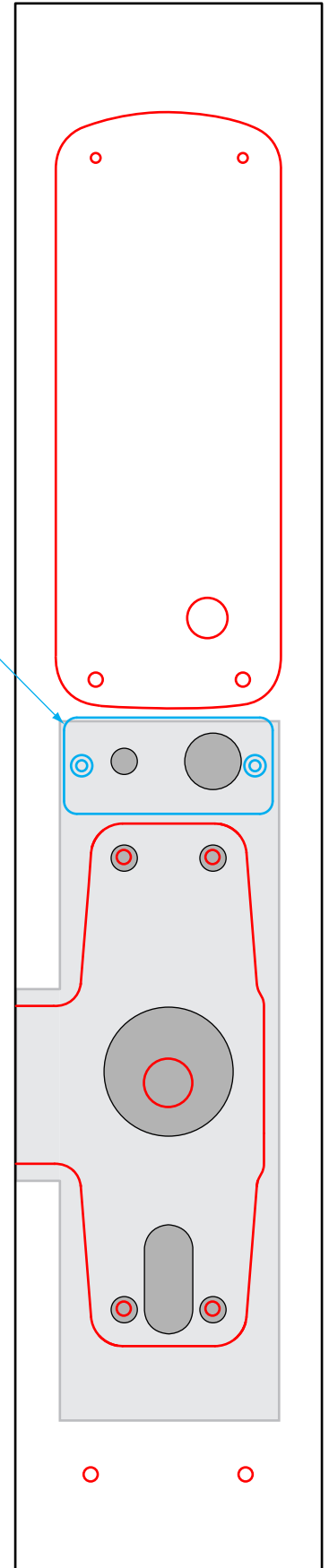

Inside Face of Door

Kaba E-Plex 5700 Exit (on Von Duprin 98/99 Rim)

	<b>Retrofitting From:</b> Kaba E-Plex 5700 Exit (on Von Duprin 98/99 Rim)
	<b>To New Lock:</b> Schlage CO-100-993 Schlage CO-200-993
	<b>Decorative Plates Required:</b> n/a

Fill hole.  
 Sexbolt with 3/8" O.D. and  
 1/4" threads installed from  
 outside recommended.

countersink  
 1/4" thread  
 flat head screw  
 on interior side

countersink  
 1/4" thread  
 flat head screws  
 on exterior side

Fill holes, 2 places.  
 Sexbolts with 3/8" O.D. and  
 1/4" threads installed from  
 inside recommended.

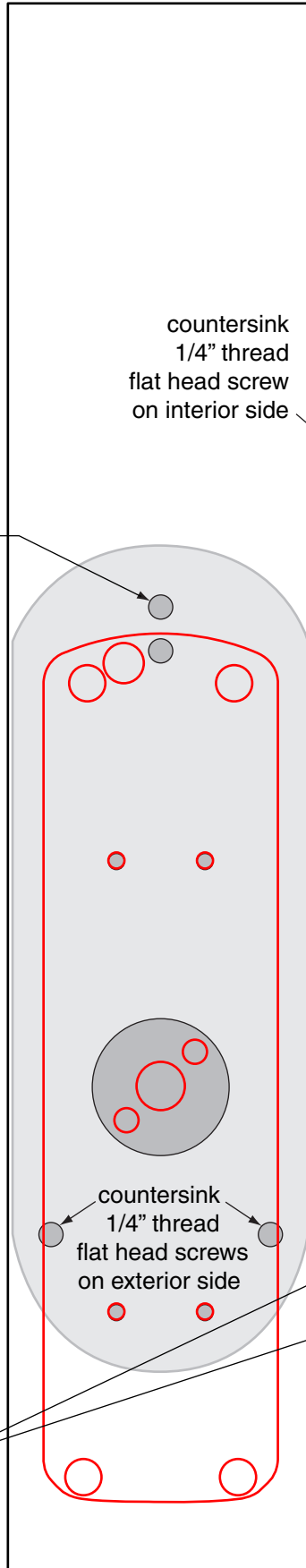

Outside Face of Door

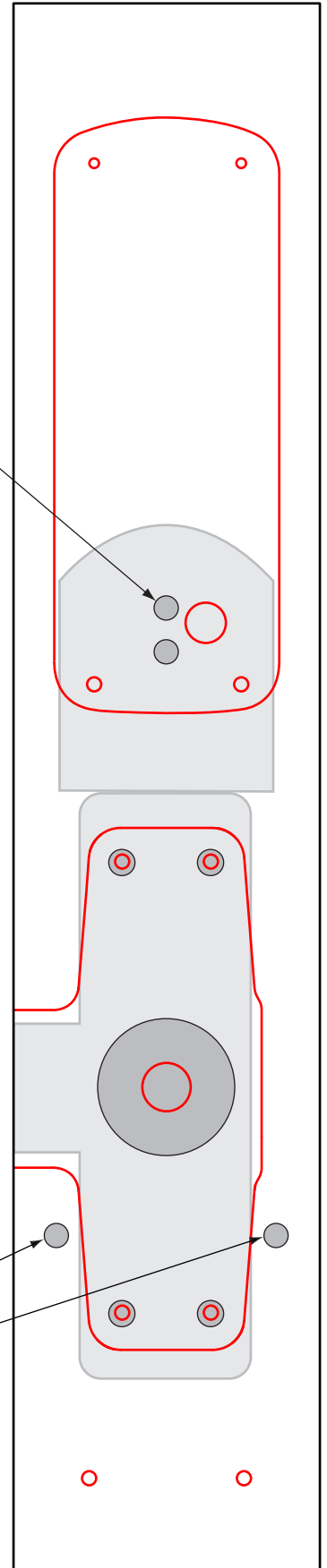

Inside Face of Door

# Sargent Profile Exit Trim (on Sargent 8800 Rim)

	<b>Retrofitting From:</b> Sargent Profile Exit Trim (on Sargent 8800 Rim)
	<b>To New Lock:</b> Schlage CO-100-993 Schlage CO-200-993
	<b>Decorative Plates Required:</b> n/a

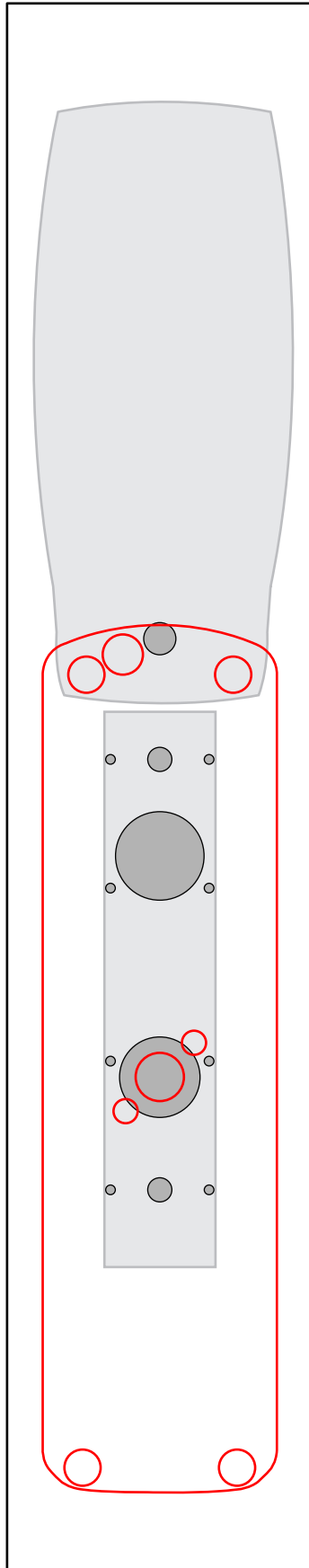

Outside Face of Door

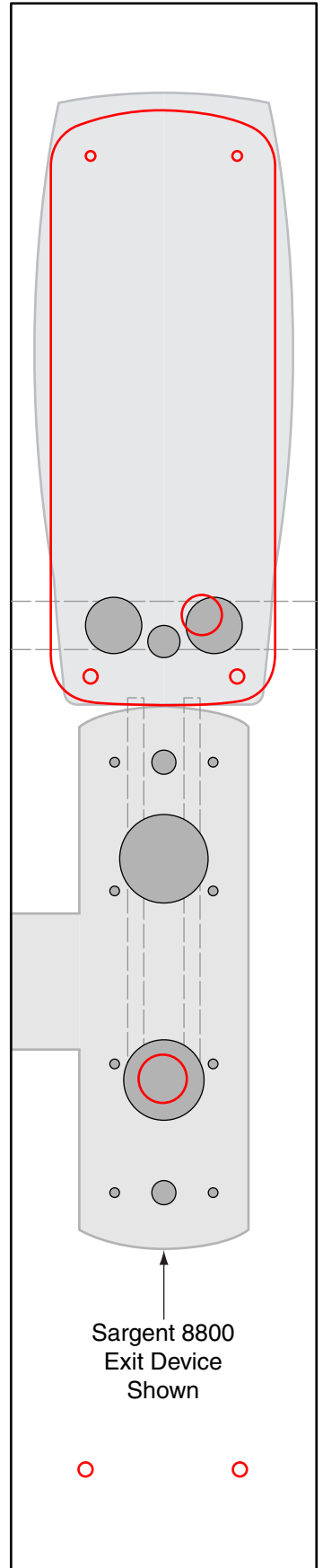

Inside Face of Door

Schlage AD-200/250/300/400-993 Exit (on Von Duprin 98/99 Rim)

	<b>Retrofitting From:</b> Schlage AD-200/250/300/400-993 Exit (on Von Duprin 98/99 Rim)
	<b>To New Lock:</b> Schlage CO-100-993 Schlage CO-200-993
	<b>Decorative Plates Required:</b> n/a

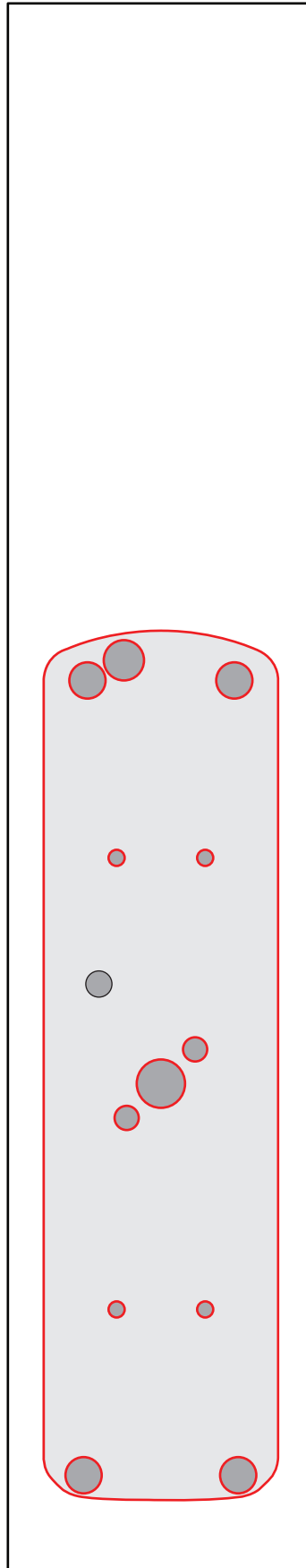

Outside Face of Door

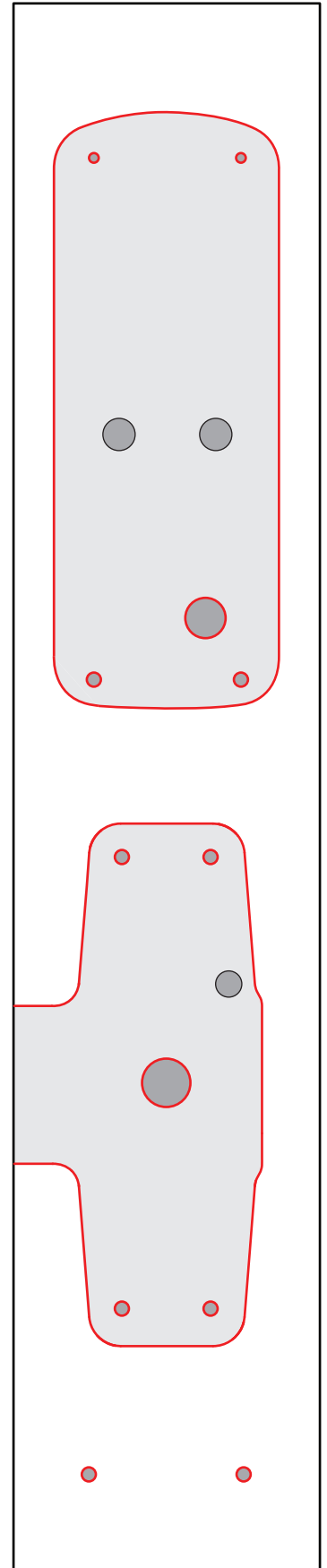

Inside Face of Door

Schlage Pro 993 Exit (on Von Duprin 98/99 Rim)

	<b>Retrofitting From:</b> Schlage Pro 993 Exit (on Von Duprin 98/99 Rim)
	<b>To New Lock:</b> Schlage CO-100-993 Schlage CO-200-993
	<b>Decorative Plates Required:</b> n/a

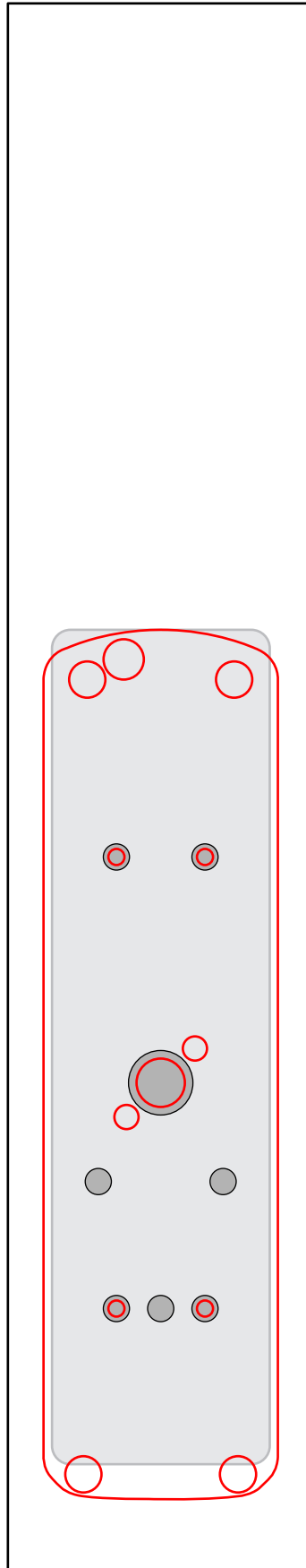



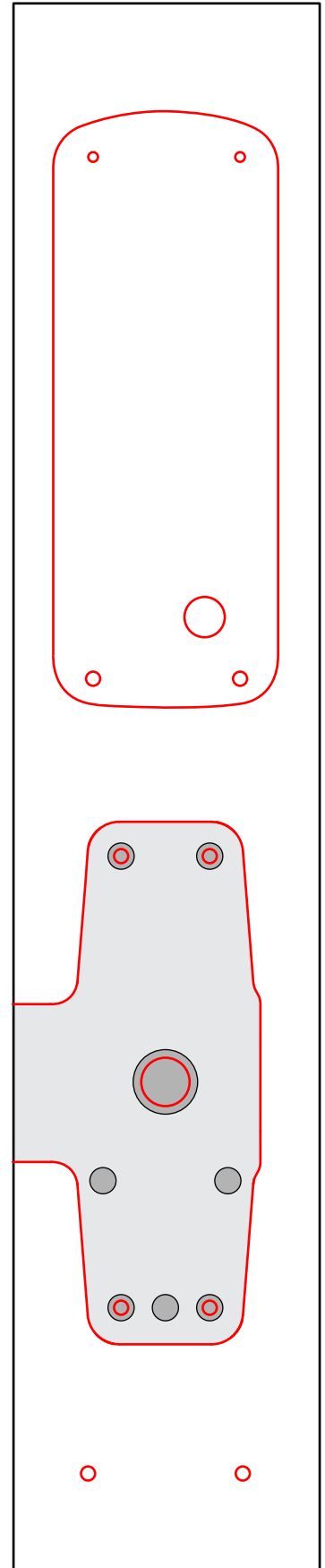

Outside Face of Door



Inside Face of Door

# Schlage WA993 Exit (on Von Duprin 98/99 Rim)

	<b>Retrofitting From:</b> Schlage WA993 Exit (on Von Duprin 98/99 Rim)	
	<b>To New Lock:</b> Schlage CO-100-993 Schlage CO-200-993	
<b>Decorative Plate Choices</b>		
<b>Surface Mounted Exit Plate</b>		
	<b>Outside</b> n/a	<b>Inside</b> <b>23631823</b> 
-----OR-----		
<b>Thru-Bolted / Under the Lock Plates</b>		
	<b>Outside</b> n/a	<b>Inside</b> n/a

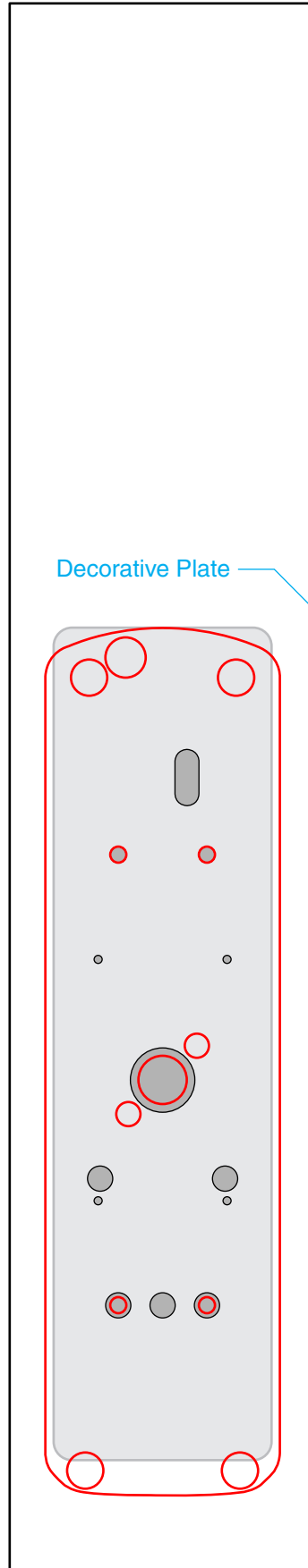

**Outside Face of Door**

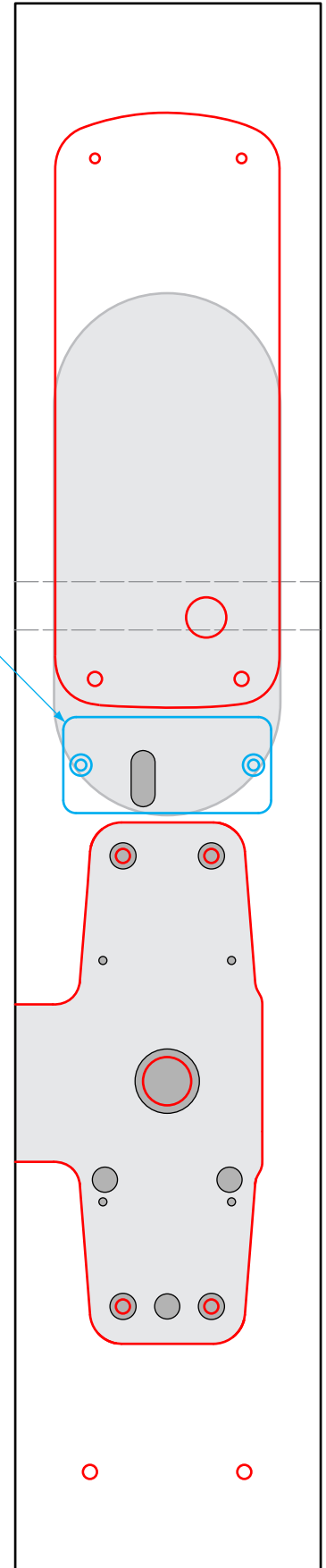



**Inside Face of Door**



## Decorative Plates

### Part Numbers and Descriptions

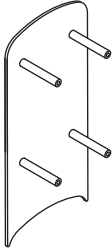
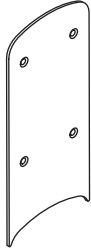
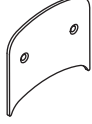
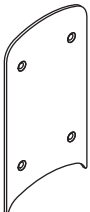
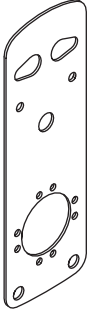
#### Cylindrical, Mortise, and Mortise Deadbolt

 <p><b>23760291</b> 8" decorative plate with welded standoffs and fasteners</p>	 <p><b>23760309</b> 8" decorative plate with fasteners</p>	 <p><b>23760283</b> 3.2" decorative plate with fasteners</p>
 <p><b>23760325</b> 6.6" decorative plate with fasteners</p>	 <p><b>23760259*</b> 10.5" under the lock decorative plate (fasteners not necessary)</p>	 <p><b>23760267</b> 1.7" decorative plate with fasteners</p>  <p><b>23760275*</b> 12" under the lock decorative plate (fasteners not necessary)</p>

#### Exit Trim

 <p><b>23631823</b> Exit trim decorative plate with fasteners</p>
--

\*A single under the lock plate will add 0.075" to the door thickness. CO-Series Devices can be ordered for door thicknesses in increments of 0.125".

Finishes (available for all plates)	Examples - Customer Order Suffix Configuration
605 Bright Brass	23760267-605
630 Satin Stainless Steel	23760259-630
643e Aged Bronze	23760291-643e + 23760309-643e

### Customer Service

1-877-671-7011

[www.allegion.com/us](http://www.allegion.com/us)

