



D-1115

FALCON®

F-19-V-LBR & 19-V-LBR

Exit Devices

Installation Instructions

5 REVERSING INSTRUCTIONS

NOTE: THE (F)19-V-LBR DEVICE IS HANDED.

NOTE: RETRACTOR CAM **D** AND DRAWBAR LEVER **C** SHOULD POINT IN THE SAME DIRECTION AND TOWARDS THE TOP OF THE DOOR WHEN DEVICE IS INSTALLED WITH TRIM.

TO CHANGE RETRACTOR CAM POSITION:

- 1) REMOVE CHASSIS COVER (2 SCREWS, COVER IS NOT SHOWN).
- 2) REMOVE HOUSING **A** (2 SCREWS).
- 3) REMOVE SLIDEBAR LEVER **B**, DRAWBAR LEVER **C** AND SLIDEBAR **F**.
- 4) ROTATE RETRACTOR CAM **D** TO CORRECT POSITION, SEE FIGURE 1 (RHR) OR FIGURE 2 (LHR).
- 5) REINSTALL SLIDE BAR **F** AND DRAWBAR LEVER **C**. SEE FIGURES BELOW.
- 6) INSTALL SLIDE BAR LEVER **B** MAKING SURE TEETH ARE ENGAGED WITH DRAWBAR LEVER **C** AND THAT NUB ON **B** FITS WITHIN SLOT IN **F**.
- 7) REASSEMBLE HOUSING **A** (2 SCREWS).
- 8) PROCEED WITH DEVICE INSTALLATION.

NOTE: A RHR DEVICE REQUIRES RHR TRIM, SEE TRIM INSTALLATION SHEET FOR TRIM REVERSING PROCEDURES.

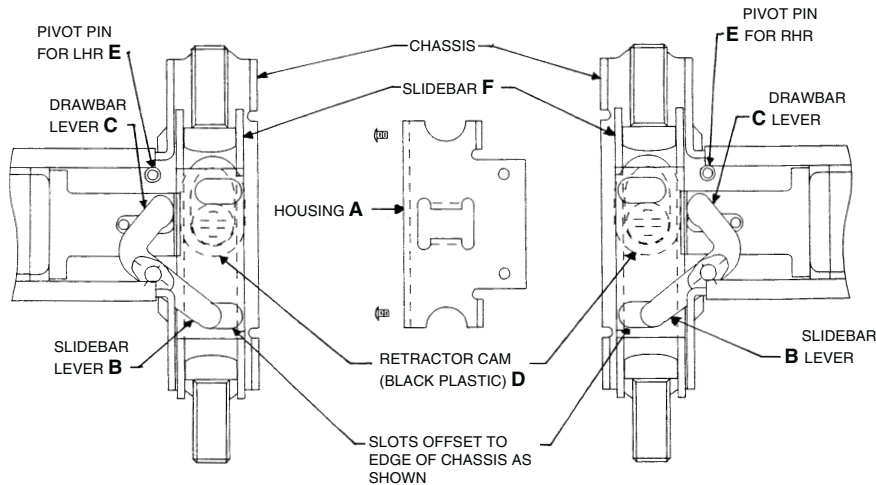



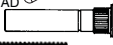





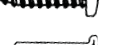
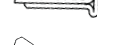

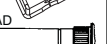











FIGURE 1: RHR

FIGURE 2: LHR

- 1) MAKE SURE THE CORRECT DEVICE IS BEING USED.
- 2) MAKE SURE DEVICE IS CORRECT HANDING, IF NOT, SEE PAGE 10 (FIGURE 1 OR FIGURE 2).
- 3) MAKE SURE ALL NEEDED PARTS ARE ON HAND.

NOTE: LIST DOES NOT REFLECT ALL POSSIBLE APPLICATIONS.

<p>1) (F) 19-V-LBR DEVICE</p> 	<p>4) SCREW PACK FOR PANIC DEVICE</p> <p>DOGGING KEY (1 QTY.) </p> <p>MOUNTING BRACKET (1 QTY.) </p> <p>SEX BOLT - 1/4"-20 THREAD (3 QTY.) </p> <p>1/4" - 20 x 3/4" TPHMS (1 QTY.) </p> <p>1/4" - 20 x 3/4" FPHMS (2 QTY.) </p> <p>#10 x 1-1/4" FPHSMS (3 QTY., 2 FINISHED) </p> <p>CHANNEL END CAP (1 QTY.) </p> <p>#10-24 x 3/8" UFPHMS w/NYLON PATCH (2 BLACK) </p> <p>#10 x 1-1/4" PPHSMS (4 QTY. [2 BLACK]) </p> <p>1/8" x 3/4" COTTER KEY (1 QTY.) </p> <p>ROD GUIDE (1 QTY.) </p>	<p>5) SCREW PACK FOR FIRE DEVICE</p> <p>MOUNTING BRACKET (1 QTY.) </p> <p>SEX BOLT - 1/4" - 20 THREAD (3 QTY.) </p> <p>1/4" - 20 X 3/4" TPHMS (1 QTY.) </p> <p>1/4" - 20 x 3/4" FPSMS (2 QTY.) </p> <p>#10 - 24 X 3/4" FPHMS (4 QTY.) </p> <p>CHANNEL END CAP (1 QTY.) </p> <p>#10-24 x 3/8" UFPHMS w/NYLON PATCH (2 BLACK) </p> <p>#10 - 24 x 3/4" PPHMS (4 QTY. [2 BLACK]) </p> <p>1/8" x 3/4" COTTER KEY (1 QTY.) </p> <p>ROD GUIDE (2 QTY.) </p>
<p>2) STRIKE</p> <p>4163/3788 </p> <p>(F)19-V</p> <p>FIRE 3788</p> <p>PANIC 4163</p>	<p>6) VERTICAL RODS (LENGTHS FOR 7'0" OPENINGS)</p> <p>TOP ROD = 36-7/8"</p>	
<p>3) TOP LATCH</p> 		

4) MAKE SURE OUTSIDE TRIM (IF BEING USED) HAS BEEN PROVIDED AND IS THE CORRECT HANDING.



Customer Service

1-877-671-7011

www.allegion.com/us

© Allegion 2014
Printed in U.S.A.
D-1115 Rev. 09/14-d

2 DOOR LAYOUT

(NOTE: FOR FACTORY PREPARED DOORS, VERIFY LAYOUT.)

- 1) DOOR MUST BE FITTED AND HUNG PROPERLY BEFORE PROCEEDING.
- 2) MARK VERTICAL ϕ AND DEVICE REF. ϕ ON DOOR AND FRAME (SEE FIGURES & CHARTS BELOW).

A) VERTICAL ϕ :

INSTALLATION	1-3/4" MIN.	3" MIN.
PAIR: (F)19-V	"B"=1-5/16"	"B"=2-1/4"

TWO VERTICAL ROD DEVICES

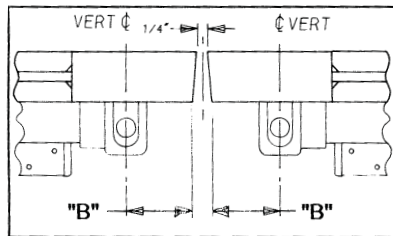

B) DEVICE REF ϕ : (HORIZONTAL)

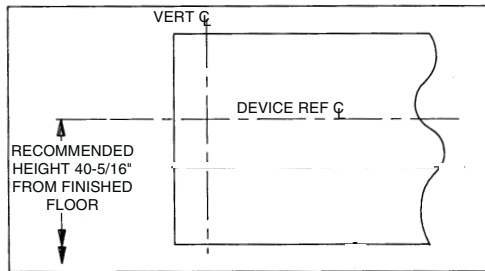

- 10) APPLY STRIKES & COVERS (NOTE: ALL SCREWS ARE BLACK).
 - A) ATTACH COVERS TO CHASSIS AND LATCH.
 - B) INSTALL ROD GUIDE.
 - C) ATTACH CHANNEL END CAP.
 - D) INSTALL STRIKES TO TOP OF DOOR FRAME.
 - E) CHECK FOR SMOOTH OPERATION.
 - F) FOR FIRE RATED DEVICES ONLY, INSTALL SPRING BOLT ASSEMBLY, SEE D-5494

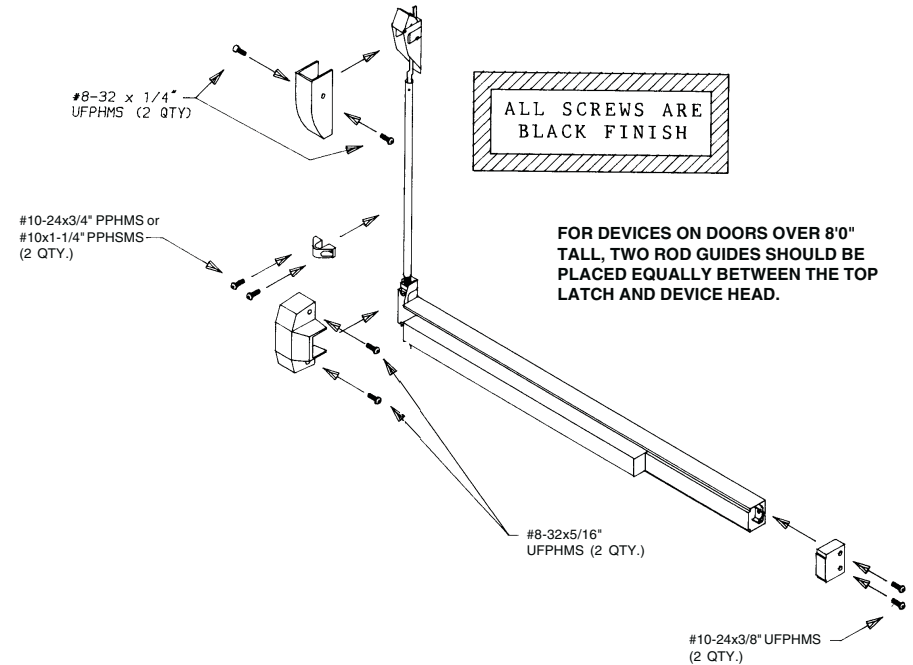

- 11) CHECK DOGGING OPERATION: (PANIC APPLICATION ONLY)
 - A) DEPRESS TOUCHBAR, INSERT AND TURN DOGGING KEY CLOCKWISE TO DOG DEVICE.

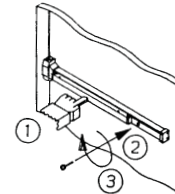

LHR SHOWN

- B) REMOVE DOGGING KEY; TOUCHBAR WILL REMAIN DEPRESSED.
- C) REINSERT DOGGING KEY AND TURN IT IN OPPOSITE DIRECTION (COUNTER-CLOCKWISE). PUSH ON TOUCHBAR AND IT WILL "POP OUT."
- D) FOR CYLINDER DOGGING, REFER TO INSTALLATION INSTRUCTION D-4080.

9) VERTICAL ROD ADJUSTMENT.

A) TOP LATCH ADJUSTMENT.

- 1) RELEASE TOP LATCHBOLT USING RELEASE TRIGGER.
 - 2) CHECK TOP LATCHBOLT PROJECTION, LATCHBOLT PROJECTION SHOULD BE 5/8" TO 3/4".
 - 3) IF THE TOP LATCHBOLT DOES NOT PROJECT THIS MUCH, REMOVE THE COTTER KEY FROM THE TOP ROD AND TURN THE TOP ROD ONE FULL TURN (SEE BELOW). RE-INSERT THE COTTER KEY. RECHECK THE INCREASED LATCHBOLT PROJECTION. REPEAT UNTIL TOP LATCHBOLT PROJECTION IS 5/8" TO 3/4".
 - 4) SLOWLY DEPRESS TOUCHBAR; LATCHBOLT SHOULD REMAIN IN RETRACTED POSITION.
 - 5) IF LATCHBOLT DOES NOT REMAIN IN RETRACTED POSITION, REMOVE COTTER KEY. DECREASE TOP LATCHBOLT PROJECTION BY ROTATING ROD 1/2 TURN (SEE BELOW).
 - 6) RE-INSERT COTTER KEY, REPEAT PROCESS UNTIL LATCHBOLT REMAINS IN RETRACTED POSITION.
- B) IF TRIM IS BEING USED, OPERATE TRIM AND CHECK FOR FULL LATCHBOLT RETRACTION. IF TOP LATCHBOLT DOES NOT REMAIN IN RETRACTED POSITION, DECREASE TOP AND BOTTOM LATCHBOLT PROJECTION (SEE BELOW).
- C) BEND COTTER KEYS AROUND RODS AND RELEASE TOP LATCHBOLT USING RELEASE TRIGGER.

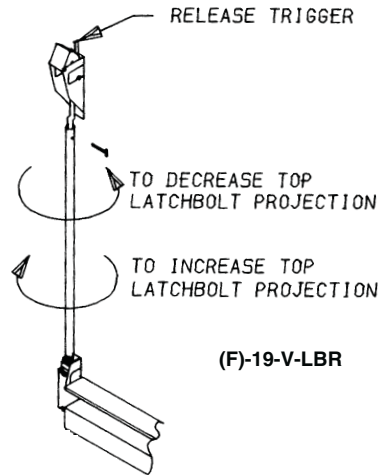

3 DOOR & HARDWARE PREPARATION

- 1) CHOOSE CORRECT DRILLING TEMPLATE FROM CENTER OF BOOK.
- 2) TAPE DRILLING TEMPLATE ON DOOR AND FRAME USING VERTICAL ϕ AND REF ϕ OF DEVICE (REFER TO **2**). CENTERPUNCH AND DRILL HOLES FOR DEVICE AND STRIKE MOUNTING AFTER DRILLING HOLES, REMOVE DRILLING TEMPLATE.

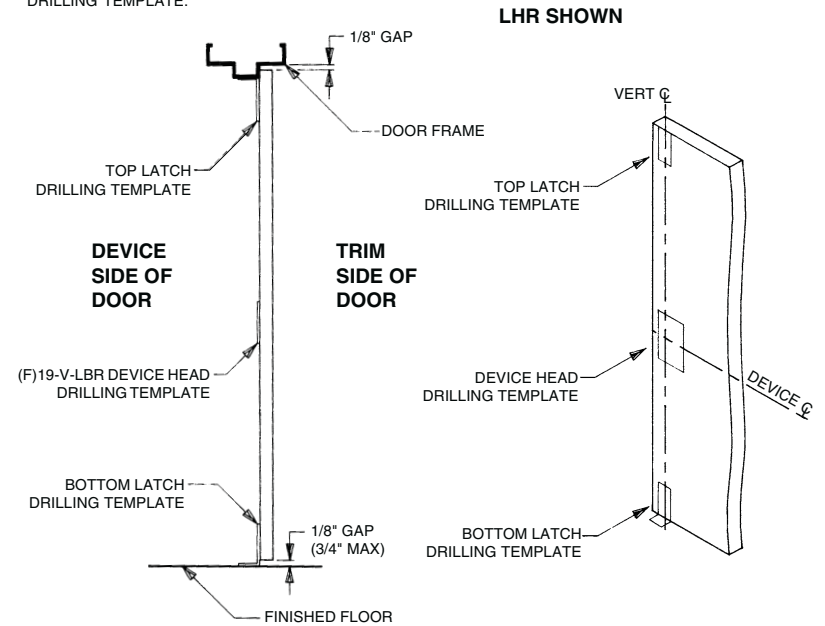

- 3) USING OUTSIDE TRIM, PREPARE DOOR USING SEPARATE TRIM DIRECTION SHEET. FOR SEXBOLT INSTALLATIONS, DRILL 3/8" DIAMETER HOLES ON TRIM SIDE OF DOOR ONLY. (SEE DIAGRAM BELOW).

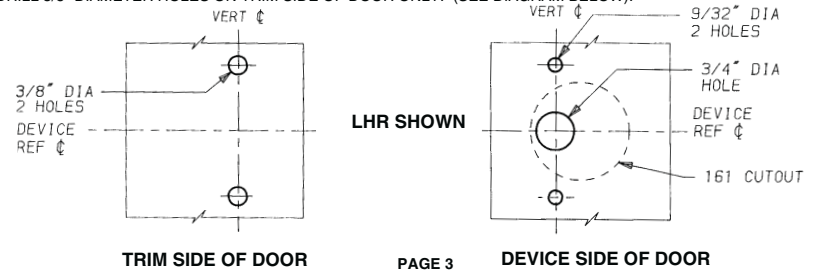

4) DETERMINE DEVICE LENGTH.

- A) LOCATE VERTICAL ϕ ON DOOR.
- B) MEASURE DISTANCE "Y" FROM VERT. ϕ TO STOP SURFACE ON HINGE SIDE.
- C) SUBTRACT 1" FOR RECOMMENDED CLEARANCE (FOR DOOR STILES LESS THAN 2-3/4" WIDE, SUBTRACT 3/4").
- D) LENGTH OF DEVICE FROM VERT. ϕ TO CUT-OFF LENGTH IS "X".

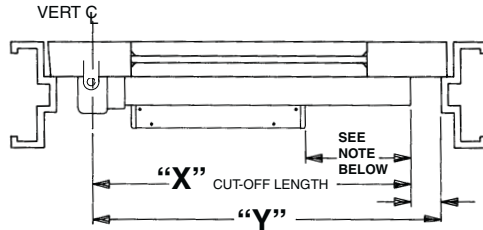

LHR SHOWN

NOTE: FOR STANDARD DOGGING: 3" MIN.
 FOR CYLINDER DOGGING: 4-1/2" MIN.
 FOR EXIT ALARM AND ELECTRIC DOGGING: 7" MIN.

- 5) IF DEVICE IS LONGER THAN "X", CUT THE DEVICE.
 - A) MARK DEVICE CHANNEL AND COVER TO LENGTH "X".

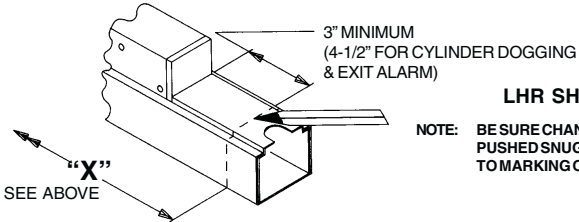

LHR SHOWN

NOTE: BE SURE CHANNEL COVER IS PUSHED SNUG TO PUSHBAR PRIOR TO MARKING OR CUTTING TO SIZE

- B) CUT BOTH CHANNEL AND CHANNEL COVER TO MARKED DIMENSION AND REMOVE BURRS.

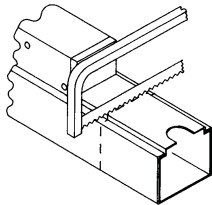

NOTE: FACTORY RECOMMENDS SAWING RATHER THAN GRIND CUT TO SIZE. GRINDING CAN DAMAGE THE FINISH OF THE DEVICE AND SAWING RESULTS IN LESS DAMAGE TO THE DEVICE'S FINISH.

- 6) DRILL MOUNTING HOLE. REMOVE CHANNEL COVER AND DRILL 5/16" DIA. HOLE ON DEVICE REF. ϕ 5/16" FROM END OF CHANNEL.

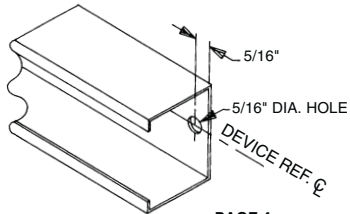

PAGE 4

- 5) INSTALL END CAP MOUNTING BRACKET USING SEX BOLT AND SCREW

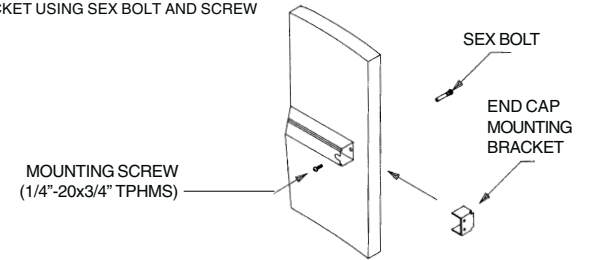

- 6) TIGHTEN ALL DEVICE MOUNTING SCREWS.
- 7) INSTALL TOP & BOTTOM LATCHES.

PANIC DEVICES

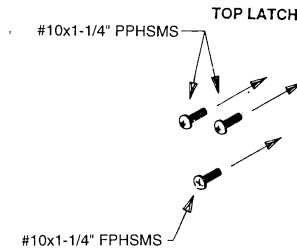

FIRE DEVICES

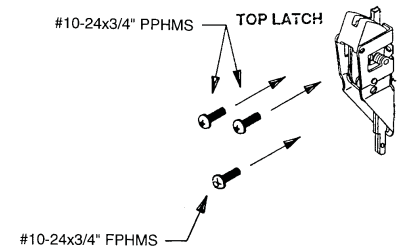

- 8) THREAD RODS ONTO DEVICE CENTERSLIDE. INSERT ROD CONNECTORS FROM TOP LATCH INTO OPPOSITE END OF TOP ROD AND INSERT (BUT DO NOT BEND) COTTER KEY THROUGH ROD AND ROD CONNECTOR. INSERT BOLT ASSEMBLY INTO OPPOSITE END OF BOTTOM ROD AND INSERT (BUT DO NOT BEND) COTTER KEY THROUGH ROD AND BOLT ASSEMBLY.

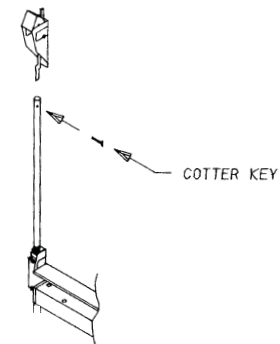

PAGE 7

- B) FOR RODS THAT ARE TOO SHORT, FOLLOW PROCEDURE BELOW.
 1) ATTACH EXTENSION RODS TO THREADED SECTION OF TOP ROD.

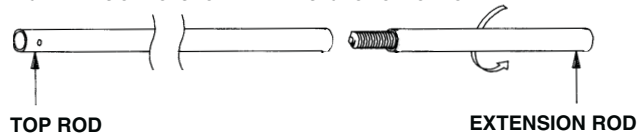

- 2) FOLLOW INSTRUCTIONS TO MARK, CUT & DRILL TOP ROD (SEE STEP 1 OF PART A OF PREVIOUS PAGE).

4 HARDWARE INSTALLATION

- 1) MOUNT OUTSIDE TRIM (WHEN REQUIRED) PER DIRECTIONS IN TRIM BOX, OR INSTALL OUTSIDE SEX BOLTS.
- 2) MOUNT DEVICE - THROUGH BOLT DEVICE TO TRIM OR SEX BOLTS.
- 3) LOCATE, MARK AND DRILL END CAP MOUNTING HOLE:
 - A) LEVEL DEVICE.
 - B) MARK CENTER OF 5/16" DIA. HOLE AT END OF CHANNEL.
 - C) DRILL 9/32" DIA. HOLE THRU DOOR.
 - D) DRILL 3/8" DIA. HOLE ON TRIM SIDE OF DOOR USING 9/32" DIA. HOLE AS GUIDE.

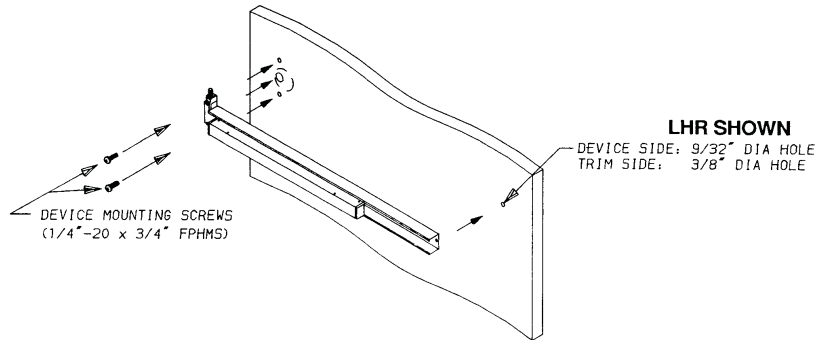

- 4) INSTALL CHANNEL COVER.

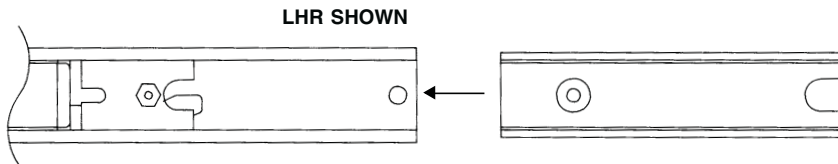

- 7) PREPARE ACCESS SLOT IN CHANNEL COVER. DRILL AN 11/16" DIA. HOLE 5/16" FROM JUST CUT END OF CHANNEL COVER. REMOVE REMAINING MATERIAL TO COMPLETE SLOT USING A SAW OR FILE.

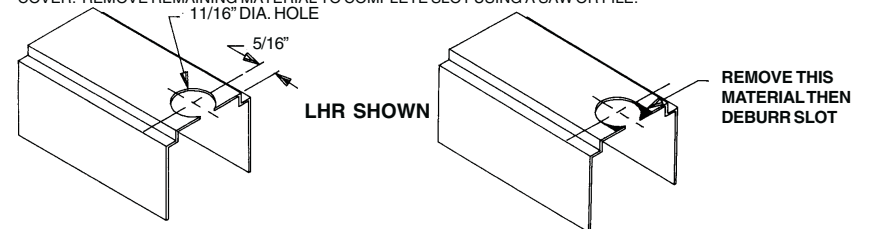

- 8) IF DOOR OPENING IS NOT 7'0", DETERMINE TOP ROD LENGTH BASED ON A 40-5/16" DEVICE REF. \bar{C} FROM FINISHED FLOOR.

- A) FOR DOOR OPENINGS UNDER 7'0":
 1) SUBTRACT DOOR OPENING FROM 7'0" OPENING.
 2) SUBTRACT ANSWER FROM PART 1 FROM 36-7/8" TO DETERMINE TOP ROD LENGTH.
 (EXAMPLE : 6'8" DOOR OPENING - 7'0" - 6'8" = 4" 36-7/8"-4"= 32-7/8" TOP ROD)

- B) FOR DOOR OPENINGS ABOVE 7'0":
 1) SUBTRACT 7'0" FROM DOOR OPENING.
 2) ADD ANSWER FROM PART 1 TO 36-7/8" TO DETERMINE TOP ROD LENGTH.
 (EXAMPLE: 8'10" DOOR OPENING - 8'10"-7'0"=22" 36-7/8"+22"=58-7/8")

- 9) MODIFY TOP ROD TO REQUIRED LENGTH.

- A) FOR RODS THAT ARE TOO LONG, FOLLOW PROCEDURE BELOW TO CUT ROD TO SIZE.
 1) MARK RODS TO REQUIRED LENGTH.

NOTE: ROD MUST BE MEASURED FROM THREADED PORTION OF ROD.
DO NOT CUT ROD AT END WITH INTERNAL THREADS.

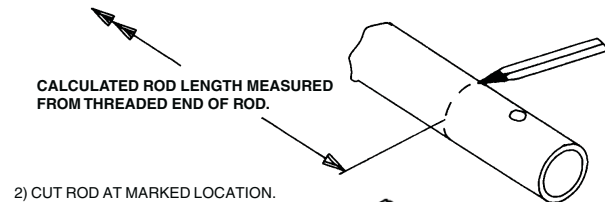

- 2) CUT ROD AT MARKED LOCATION.

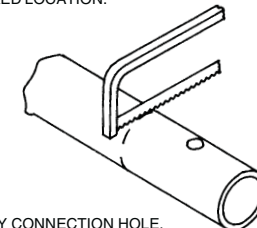

- 3) DRILL COTTER KEY CONNECTION HOLE.
 DRILL 1/8" DIA. HOLE THRU ON VERTICAL ROD 7/16" FROM END OF ROD JUST CUT.

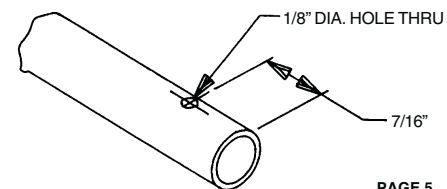

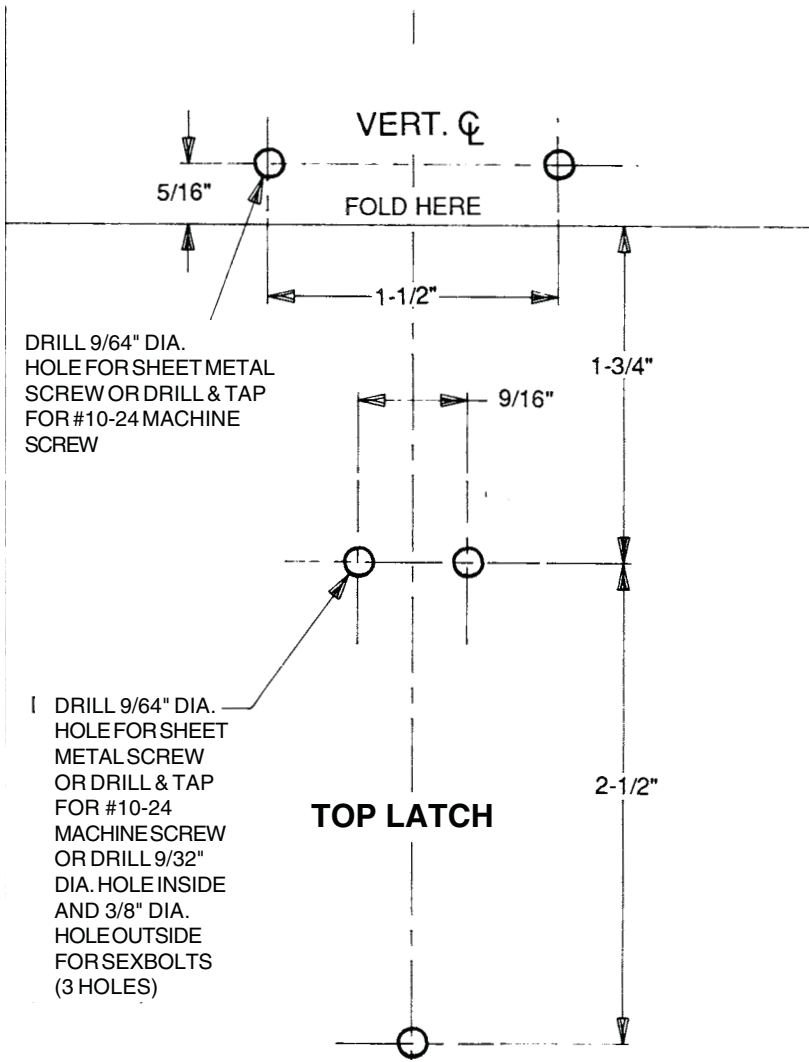

FOR KIL, KIK & CENTRON TRIM:

DRILL 9/32" DIA. HOLE FOR THRU-BOLTING AT LOCATION "A" (2 HOLES)

FOR ALL OTHER APPLICATIONS:

DRILL 9/32" DIA. HOLE FOR THRU-BOLTING OR DRILL & TAP FOR 1/4"-20 TPHMS AT LOCATION "B" (2 HOLES)

