

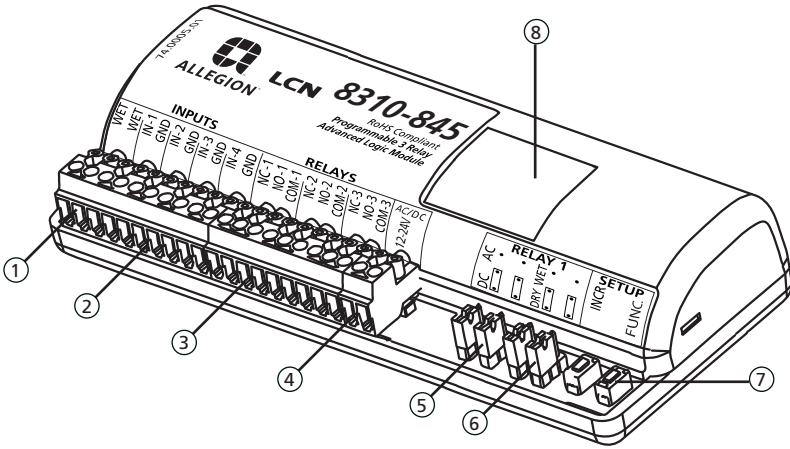

# 8310-845

Programmable, 3-Relay, Advanced  
Logic Module & Restroom Controller  
(US version)



- |                  |                        |
|------------------|------------------------|
| 1. WET input     | 5. AC/DC jumpers       |
| 2. DRY inputs    | 6. WET/DRY jumpers     |
| 3. Relay outputs | 7. Programming buttons |
| 4. Power input   | 8. 7-segment display   |

## PRECAUTIONS



**CAUTION**

- ❑ Shut off all power going to header before attempting any wiring procedures.
- ❑ Maintain a clean & safe environment when working in public areas.
- ❑ Constantly be aware of pedestrian traffic around the door area.
- ❑ Always stop pedestrian traffic through the doorway when performing tests that may result in unexpected reactions by the door.
- ❑ ESD (electrostatic discharge): Circuit boards are vulnerable to damage by electrostatic discharge. Before handling any board ensure you dissipate your body's ESD charge.
- ❑ Always check placement of all wiring before powering up to ensure that moving door parts will not catch any wires and cause damage to equipment.
- ❑ Ensure compliance with all applicable safety standards (i.e. ANSI A156.10) upon completion of installation.
- ❑ DO NOT attempt any internal repair of the components. All repairs and/or component replacements must be performed by Allegion, Inc. Unauthorized disassembly or repair:
  1. May jeopardize personal safety and may expose one to the risk of electrical shock.
  2. May adversely affect the safe and reliable performance of the product resulting in a voided warranty.

## JUMPERS

### PRECAUTIONS TO OBSERVE WHEN USING A 'WET' OUTPUT

- ❑ Never change the jumper settings when the module has power connected to it or when a load is applied.
- ❑ Never allow 2 different voltage sources to be connected to the load (electric strike for example) at the same time. This can result in serious damage to equipment.
- ❑ Always move both jumpers when changing a jumper set.
- ❑ If an EL device is being powered by a separate power source, DO NOT select the 'WET' output option on the 8310-845. If 'WET' is selected, the next activation of the module will send a voltage to the load and if there is already a voltage being applied from another source, the 8310-845 and possibly the load will be permanently damaged.
- ❑ When using the 'WET' output option on the 8310-845, set all desired switch positions ('WET' – 'DRY' and AC – DC) before the module is powered and before any loads are applied.
- ❑ When DC 'WET' output is selected, COM terminal is positive (+) and the ground (-) is switched between NO and NC.
- ❑ Ensure there is no other voltage connected to the load. Whatever the input voltage is at the 8310-845, the output will correspond. The following can also be observed:
  1. If voltage input at the 8310-845 is AC, then output selection can be AC or DC.
  2. If voltage input at the 8310-845 is DC, then output selection can only be DC.
  3. The maximum load applied to Relay 1 should never exceed 1A. If more than one device is to be connected, add the consumption values together for a total value. If current is excessive, damage to equipment can result.
  4. On the 8310-845, the 'WET' output is only available at Relay 1.
- ❑ When supplying 8310-845 with AC input voltage and selecting Relay 1 output for 'WET' and DC OUTPUT VOLTAGE, note that the resulting DC output will be the rectified AC input voltage and therefore, about 40% higher than the AC input voltage (rms).

**CAUTION: Relay 1 'WET' OPTION IS ACTIVE FOR ALL FUNCTIONS!**

RELAY 1 OUTPUT	DRY/WET JUMPER <sup>2</sup>	AC OUTPUT VOLTAGE <sup>3</sup>	DC OUTPUT VOLTAGE <sup>4</sup>
DRY	both jumpers set to DRY	N/A	N/A
WET <sup>1</sup>	both jumpers set to WET	both jumpers set to AC	both jumpers set to DC

#### NOTES:

1. "WET output" allows the 8310-845 to supply a voltage output of up to 1 A on relay 1 for powering Maglocks or Electric Strikes directly from the 8310-845. Rating of power supply which powers the 8310-845 must be at least 1 A.
2. Default jumper settings make relay 1 DRY.
3. AC voltage only available if 8310-845 is powered by AC voltage.
4. DC voltage available if 8310-845 is powered by AC or DC voltage.

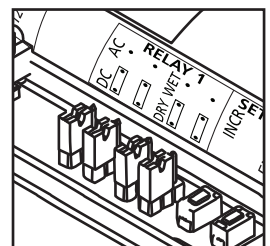

## WIRING

Each 8310-845 function is wired differently. Please review and follow the appropriate wiring diagram shown for each function.

## FUNCTIONS

FUNCTION	DESCRIPTION	LOGIC
10	timer	<ul style="list-style-type: none"> <li>activation of <b>relay 1</b> via trigger of <b>input 1</b></li> <li><b>reverse logic</b> available</li> </ul>
11	ratchet / latching	<ul style="list-style-type: none"> <li>ratchet/latching of <b>relay 1</b> via trigger of <b>input 1</b></li> </ul>
22	2-relay sequencer + inhibitor	<ul style="list-style-type: none"> <li>sequence of <b>relay 1</b> and <b>relay 2</b> with inhibiting of <b>input 1</b> until <b>input 2</b>, <b>input 3</b>, or <b>WET input</b> is triggered</li> <li>activation of <b>input 4</b> reinhibits <b>input 1</b></li> </ul>
28	2-relay sequencer + door position	<ul style="list-style-type: none"> <li>sequence of <b>relay 1</b> and <b>relay 2</b> via trigger of <b>input 1</b> or <b>WET input</b></li> <li><b>input 2</b> allows delay to run when open but not when closed</li> </ul>
29	deactivation timer	<ul style="list-style-type: none"> <li>sequence of <b>relay 1</b> and <b>relay 2</b> via trigger of <b>input 1</b> or <b>WET input</b></li> <li><b>input 2</b>, once opened after sequence, allows <b>relay 1</b> to deactivate</li> <li><b>input 2</b> allows delay to run when open but not when closed</li> <li><b>input 3</b> disables sequence, <b>reverse logic</b> available</li> </ul>
36	3-relay sequencer + '1-shot'	<ul style="list-style-type: none"> <li>sequence of <b>relay 1</b> and <b>relay 2</b> and <b>relay 3</b> via trigger of <b>input 1</b> or <b>WET input</b></li> <li><b>relay 1</b>, <b>relay 2</b>, and <b>relay 3</b> can be maintained or '1-shot'</li> </ul>
37	3-relay sequence with 'independent relay'	<ul style="list-style-type: none"> <li>sequence of <b>relay 1</b> and <b>relay 2</b> and <b>relay 3</b> via trigger of <b>input 1</b> or <b>WET input</b></li> <li><b>relay 1</b>, <b>relay 2</b>, and <b>relay 3</b> can be 'independent' or sequenced</li> </ul>
50	interlock timer	<ul style="list-style-type: none"> <li>interlock of <b>relay 1</b> and <b>relay 2</b> via trigger of <b>input 1</b> and <b>input 2</b>, respectively</li> </ul>
55	interlock ratchet / latching	<ul style="list-style-type: none"> <li>interlock ratchet of <b>relay 1</b> and <b>relay 2</b> via trigger of <b>input 1</b> and <b>input 2</b>, respectively</li> </ul>
65	2-way 2-relay sequence	<ul style="list-style-type: none"> <li>sequence of <b>relay 1</b> and <b>relay 2</b> via trigger of <b>input 1</b></li> <li>sequence of <b>relay 2</b> and <b>relay 1</b> via trigger of <b>input 2</b></li> <li><b>input 3</b> triggers <b>relay 1</b> individually, <b>input 4</b> triggers <b>relay 2</b> individually</li> </ul>
nL	normally locked restroom	<ul style="list-style-type: none"> <li>sequence of <b>relay 1</b> (lock), <b>relay 2</b> (door), and <b>relay 3</b> (occupied indicators) for normally locked, single occupancy restrooms</li> </ul>
nU	normally unlocked restroom	<ul style="list-style-type: none"> <li>sequence of <b>relay 1</b> (lock), <b>relay 2</b> (door), and <b>relay 3</b> (occupied indicators) for normally unlocked, single occupancy restrooms</li> </ul>
dN	3-relay sequencer + 'day / night mode'	<ul style="list-style-type: none"> <li>sequence of <b>relay 1</b> and <b>relay 2</b> and <b>relay 3</b> via trigger of <b>input 1</b> or <b>WET input</b></li> <li><b>input 2</b> operation dependent upon <b>input 4</b> ('day / night mode')</li> </ul>
00	disable	<ul style="list-style-type: none"> <li>8310-845 disabled</li> <li>00 is the default setting and has no assigned function</li> </ul>

## PARAMETERS

PARAMETER	DESCRIPTION	LOGIC
h1	relay 1 hold time	<p>00 - 60 seconds</p> <p>countdown begins AFTER release of input 1 or WET input</p>
h2	relay 2 hold time	<p>00 - 60 seconds</p> <p>countdown begins AFTER d1 (delay between relay 1 &amp; relay 2) expires</p>
h3	relay 3 hold time	<p>00 - 60 seconds</p> <p>countdown begins AFTER d2 (delay between relay 1 &amp; relay 3) expires</p>
d1	delay between relay 1 & relay 2	<p>00 - 60, _1 (1/4), _2 (1/2), _3 (3/4) seconds</p> <p>delay begins AT activation of input 1 or WET input</p>
d2	delay between relay 1 & relay 3	<p>00 - 60, _1 (1/4), _2 (1/2), _3 (3/4) seconds</p> <p>delay begins AT activation of input 1 or WET input</p>
rL	reverse logic	<p>00 = normal logic</p> <p>input 1 trigger must be NO and close its contact to trigger</p> <p>01 = reverse logic</p> <p>input 1 trigger must be NC and open its contact to trigger</p>
nP	no parameters	no parameters available for selected function

# PROGRAMMING

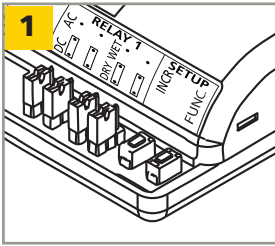

Press and hold INCR + FUNC for 3 seconds.

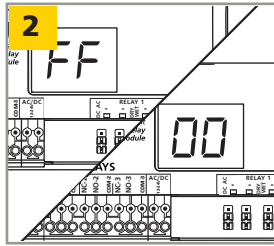

Display will toggle between FF and 00 for 5 seconds.<sup>1,2</sup>

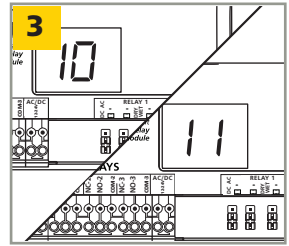

While FF / 00 is displayed, press INCR to cycle through functions.

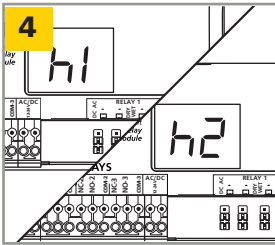

Once desired function is selected, press FUNC to cycle through parameters.

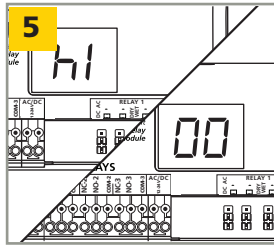

Display will toggle between parameter and its current value for 5 seconds.

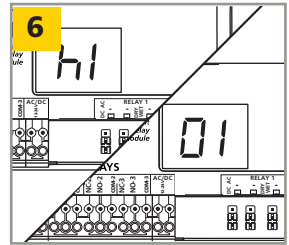

Press<sup>3</sup> INCR to cycle through parameter's values.

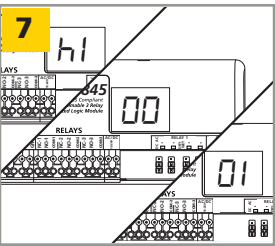

Repeat steps 4-7 until all function parameters are set.

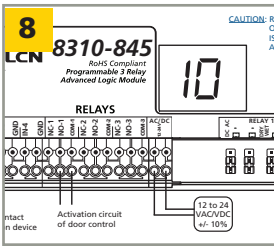

Wait 5 seconds for 8310-845 to save and display function.



Relay hold time(s) and delay time(s) MUST be set for any relay that is to be utilized.

Ex: For function 36, if using only relay 1, h1 must be set...if using relay 1 and relay 2, h1, h2, and d1 must be set.

## NOTES:

1. Function 00 disables the 8310-845.
2. "nP" means no parameters are applicable for the selected function.
3. Pressing and holding INCR will rapid cycle.

## PROGRAMMING PARAMETERS

\* see page 3 for specific parameter details \*

### 10 – timer

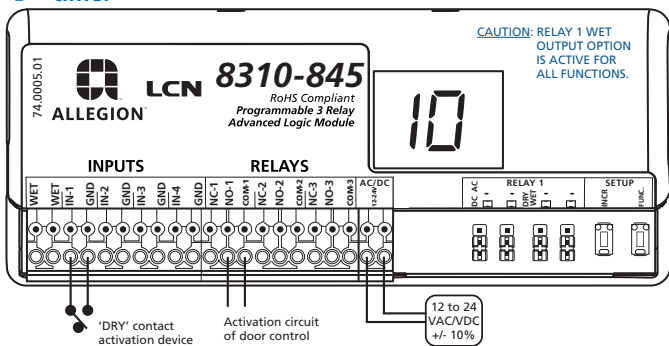

#### AVAILABLE PARAMETERS:

$h_1$  - relay 1 hold time  
 $rL$  - reverse logic

1. Trigger INPUT 1.
  - RELAY 1 will close and hold for time  $h_1$ .

FUNCTION 10 NOTE: Reverse logic allows for a Normally Closed (NC) INPUT 1.

### 11 – ratchet / latching

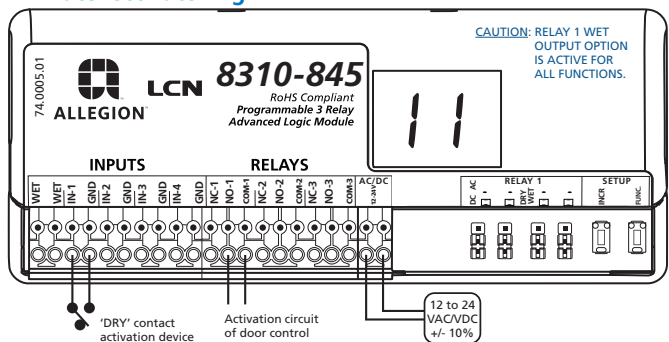

#### AVAILABLE PARAMETERS:

NONE

1. Trigger INPUT 1.
  - RELAY 1 will close and hold indefinitely.
2. Trigger INPUT 1.
  - RELAY 1 will open.

### 22 – 2-relay sequencer + inhibitor

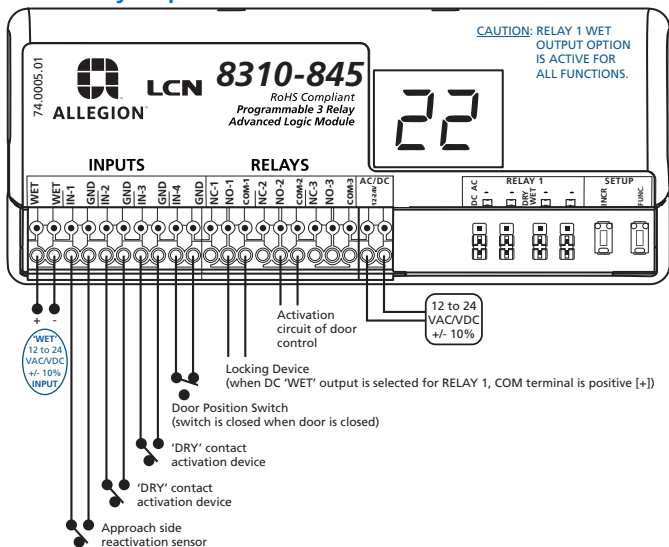

#### AVAILABLE PARAMETERS:

$h_1$  - relay 1 hold time  
 $h_2$  - relay 2 hold time  
 $d_1$  - delay between relays 1 & 2

$h_1$  must be greater than  $d_1$  when using an electric lock

1. Trigger INPUT 2, 3, or 'WET'.
  - RELAY 1 will close and hold for time  $h_1$ .
  - RELAY 2 will close after time delay  $d_1$  and hold for time  $h_2$ .

FUNCTION 22 NOTE: Ensure INPUT 1 does not initiate the sequence and that INPUT 4 is closed when the door is closed.

## PROGRAMMING PARAMETERS (cont)

### 28 – 2-relay sequencer + door position

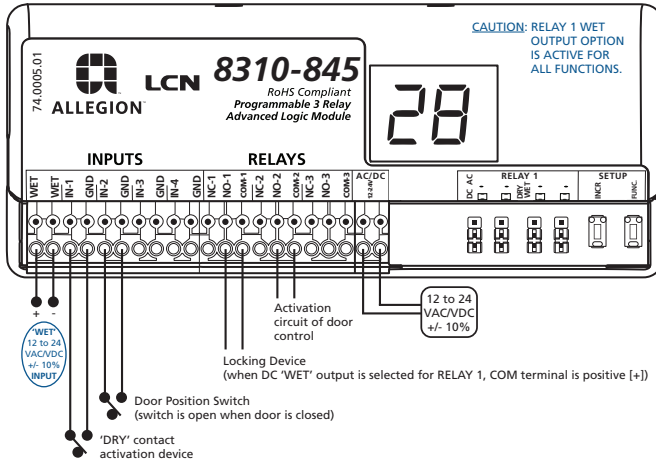

#### AVAILABLE PARAMETERS:

$h_1$  - relay 1 hold time  
 $h_2$  - relay 2 hold time  
 $d_1$  - delay between relays 1 & 2

$h_1$  must be greater than  $d_1$  when using an electric lock

1. Trigger INPUT 1 or 'WET':
  - RELAY 1 will close and hold for time  $h_1$ .
  - RELAY 2 will close after time delay  $d_1$  and hold for time  $h_2$ .

FUNCTION 28 NOTE: INPUT 2 allows the delay to run when the contact is open but triggers RELAY 2 immediately when the contact is closed.

### 29 – deactivation timer

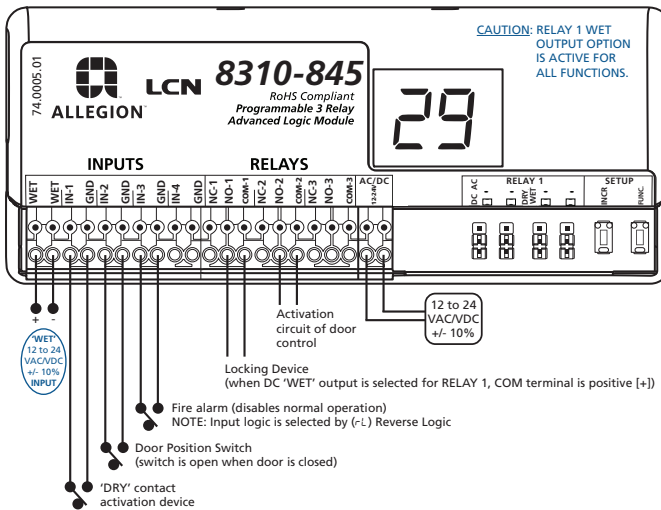

#### AVAILABLE PARAMETERS:

$h_1$  - relay 1 hold time  
 $h_2$  - relay 2 hold time  
 $d_1$  - delay between relays 1 & 2  
 $r_L$  - reverse logic

$h_1$  must be greater than  $d_1$  when using an electric lock

1. Trigger INPUT 1 or 'WET':
  - RELAY 1 will close and hold for time  $h_1$ .
  - RELAY 2 will close after time delay  $d_1$  and hold for time  $h_2$ .

#### FUNCTION 29 NOTE:

INPUT 2 deactivates RELAY 1 once INPUT 2 is opened (and after the sequence has run).

INPUT 2 allows the delay to run when the contact is open, but triggers RELAY 2 immediately when the contact is closed.

INPUT 3 disables the sequence.

# PROGRAMMING PARAMETERS (cont)

## 36 – 3-relay sequencer + '1-shot'

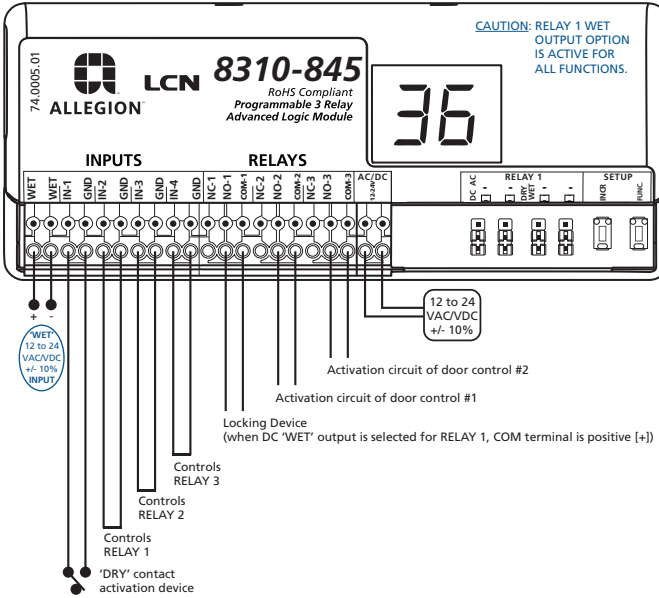

### AVAILABLE PARAMETERS:

- $h_1$  - relay 1 hold time
- $h_2$  - relay 2 hold time
- $h_3$  - relay 3 hold time
- $d_1$  - delay between relays 1 & 2
- $d_2$  - delay between relays 1 & 3

$h_1$  must be greater than  $d_1$  when using an electric lock

1. Trigger INPUT 1 or 'WET':
  - RELAY 1 will close and hold for time  $h_1$ .
  - RELAY 2 will close after time delay  $d_1$  and hold for time  $h_2$ .
  - RELAY 3 will close after time delay  $d_2$  and hold for time  $h_3$ .

FUNCTION 36 NOTE: If INPUT 1 or 'WET' is maintained, jumping INPUT 2, 3, and/or 4 will allow RELAY 1, 2, and/or 3 (respectively) to close, run the hold time and then open. If no jumpers are set, RELAYS 1, 2, and/or 3 will close, hold and not time out (open, i.e. 1-shot) until INPUT 1 or 'WET' is released.

## 37 – 3-relay sequence with 'independent relay'

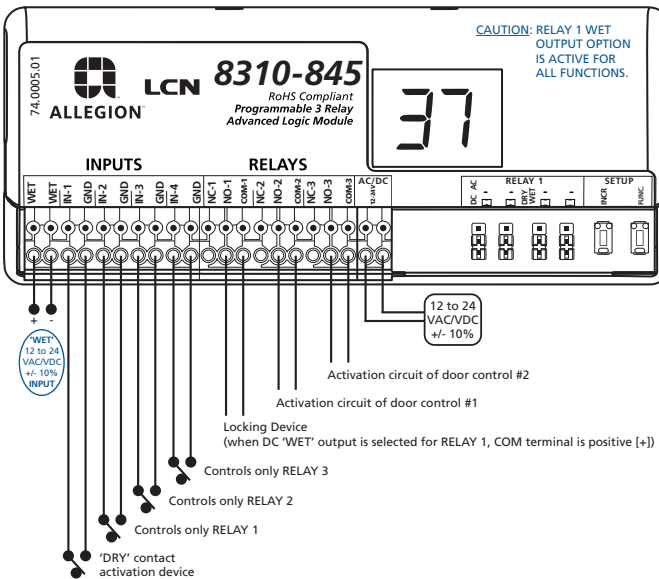

### AVAILABLE PARAMETERS:

- $h_1$  - relay 1 hold time
- $h_2$  - relay 2 hold time
- $h_3$  - relay 3 hold time
- $d_1$  - delay between relays 1 & 2
- $d_2$  - delay between relays 1 & 3

$h_1$  must be greater than  $d_1$  when using an electric lock

1. Trigger INPUT 1 or 'WET':
  - RELAY 1 will close and hold for time  $h_1$ .
  - RELAY 2 will close after time delay  $d_1$  and hold for time  $h_2$ .
  - RELAY 3 will close after time delay  $d_2$  and hold for time  $h_3$ .
2. Trigger INPUT 2:
  - RELAY 1 will close and hold for time  $h_1$ .
3. Trigger INPUT 3:
  - RELAY 2 will close and hold for time  $h_2$ .
4. Trigger INPUT 4:
  - RELAY 3 will close and hold for time  $h_3$ .

# PROGRAMMING PARAMETERS (cont)

## 50 – interlock timer

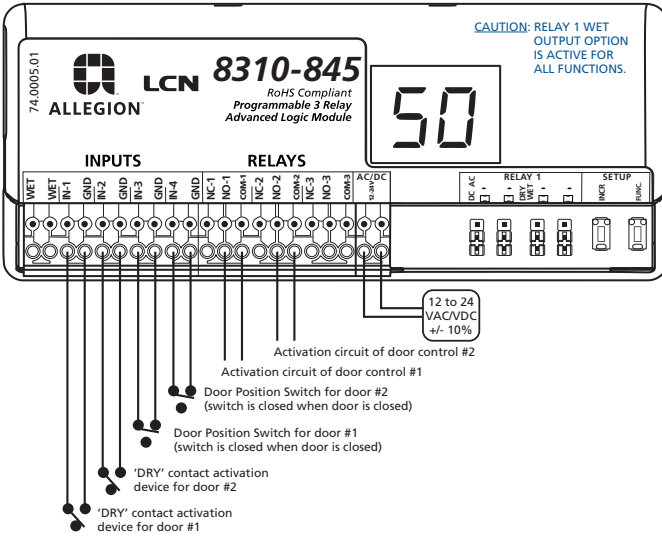

### AVAILABLE PARAMETERS:

h1 - relay 1 hold time  
h2 - relay 2 hold time

1. Trigger INPUT 1.
  - RELAY 1 will close and hold for time h1.
2. Trigger INPUT 2.
  - RELAY 2 will close and hold for time h2.

FUNCTION 50 NOTE: If INPUT 1 is triggered, INPUT 2 and RELAY 2 will be inhibited until INPUT 3 (door position switch) is closed. Conversely, if INPUT 2 is triggered, INPUT 1 and RELAY 1 will be inhibited until INPUT 4 (door position switch) is closed.

## 55 – interlock ratchet / latching

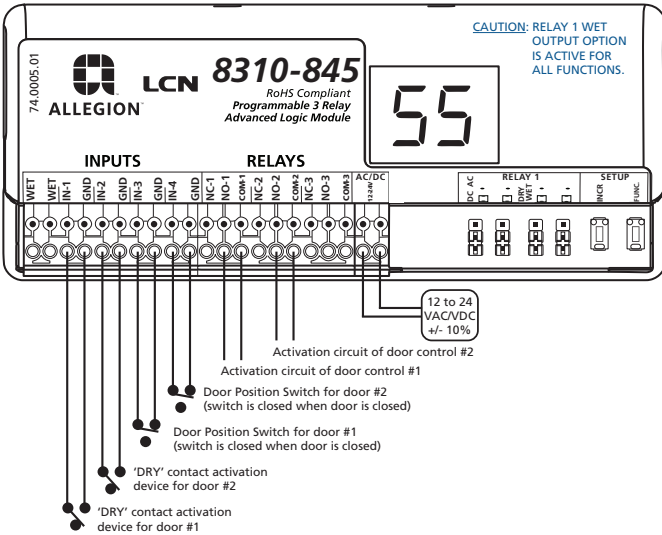

### AVAILABLE PARAMETERS:

NONE

1. Trigger INPUT 1.
  - RELAY 1 will close and hold until indefinitely.
2. Trigger INPUT 1.
  - RELAY 1 will open.
3. Trigger INPUT 2.
  - RELAY 2 will close and hold indefinitely.
4. Trigger INPUT 2.
  - RELAY 2 open.

FUNCTION 55 NOTE: If INPUT 1 is triggered, INPUT 2 and RELAY 2 will be inhibited until INPUT 3 (door position switch) is closed. Conversely, if INPUT 2 is triggered, INPUT 1 and RELAY 1 will be inhibited until INPUT 4 (door position switch) is closed.



65 – 2-way 2-relay sequence

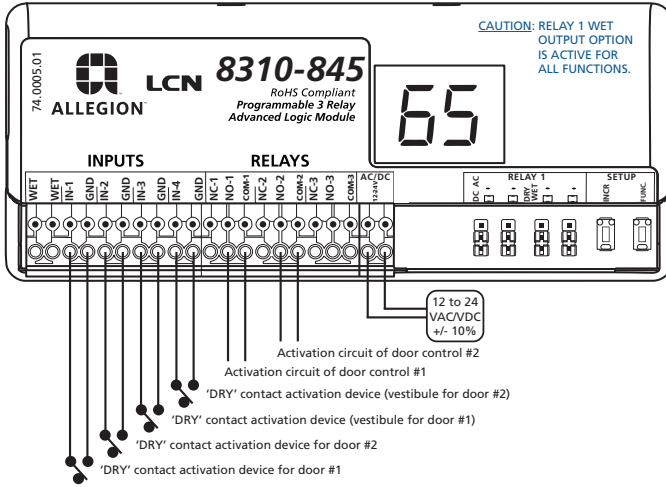

AVAILABLE PARAMETERS:

$h_1$  - relay 1 hold time  
 $h_2$  - relay 2 hold time  
 $d_1$  - delay between relays 1 & 2  
 $d_2$  - delay between relays 2 & 1

1. Trigger INPUT 1.
  - RELAY 1 will close and hold for time  $h_1$ .
  - RELAY 2 will close after time delay  $d_1$  and hold for time  $h_2$ .
2. Trigger INPUT 2.
  - RELAY 2 will close and hold for time  $h_2$ .
  - RELAY 1 will close after time delay  $d_2$  and hold for time  $h_1$ .
3. Trigger INPUT 3.
  - RELAY 1 will close and hold for time  $h_1$ .
4. Trigger INPUT 4.
  - RELAY 2 will close and hold for time  $h_2$ .

$nL$  – normally locked restroom

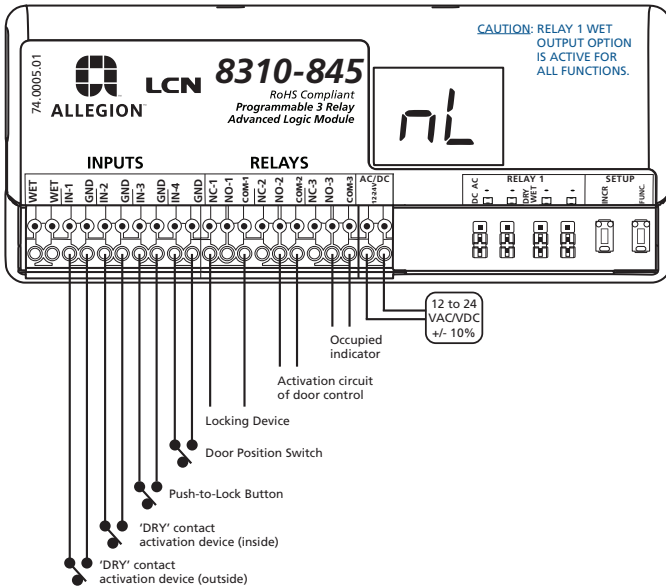

AVAILABLE PARAMETERS:

$h_1$  - relay 1 hold time  
 $h_2$  - relay 2 hold time  
 $d_1$  - delay between relays 1 & 2

$h_1$  must be greater than  $d_1$

1. Trigger INPUT 1.
  - RELAY 1 will close and hold for time  $h_1$ .
  - RELAY 2 will close after time delay  $d_1$  and hold for time  $h_2$ .
2. Trigger INPUT 3.
  - RELAY 3 will close and INPUT 1 will be inhibited.
3. Trigger INPUT 2.
  - RELAY 1 will close and hold for time  $h_1$ .
  - RELAY 2 will close after time delay  $d_1$  and hold for time  $h_2$ .
  - RELAY 3 will open.

FUNCTION  $nL$  NOTE: INPUT 3 will not function unless INPUT 4 is closed. INPUT 4 should be closed when door is closed.

# PROGRAMMING PARAMETERS (cont)

## nU – normally unlocked restroom

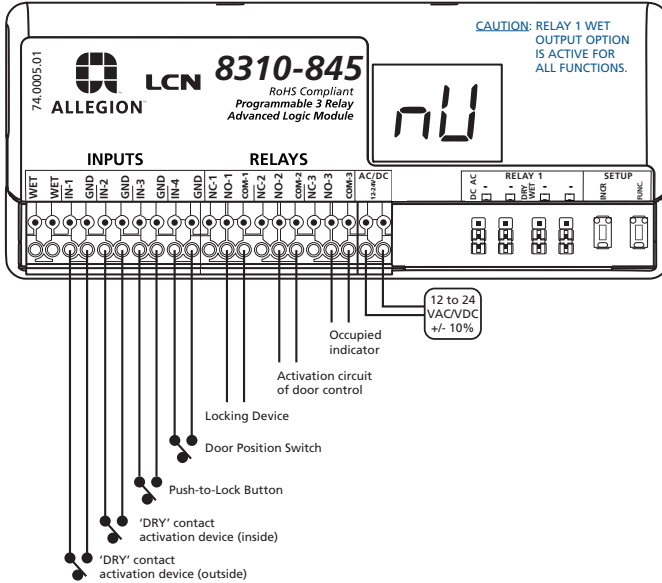

### AVAILABLE PARAMETERS:

h2 - relay 2 hold time  
d l - delay between relays 1 & 2

1. Trigger INPUT 1.
  - RELAY 2 will close and hold for time h2.
2. Trigger INPUT 3.
  - RELAY 1 and 3 will close and INPUT 1 will be inhibited.
3. Trigger INPUT 2.
  - RELAY 1 will open.
  - RELAY 2 will close after time delay d l and hold for time h2.
  - RELAY 3 will open.

FUNCTION nU NOTE: INPUT 3 will not function unless INPUT 4 is closed. INPUT 4 should be closed when door is closed.

## dN – 3-relay sequence with 'day / night mode'

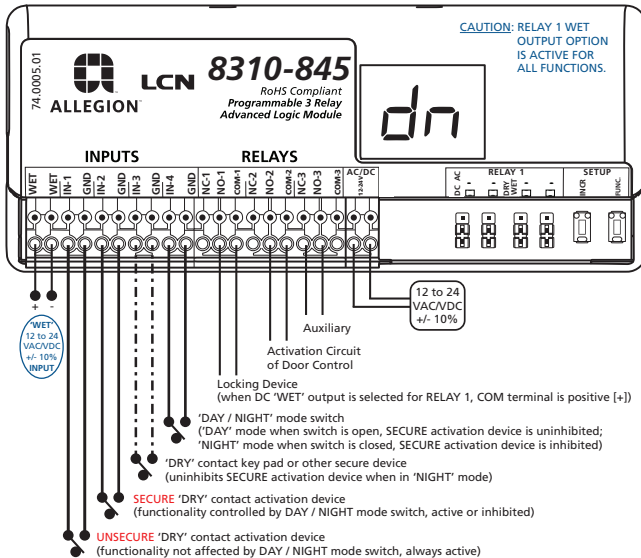

### AVAILABLE PARAMETERS:

h 1 - relay 1 hold time  
h2 - relay 2 hold time  
h3 - relay 3 hold time  
d l - delay between relays 1 & 2  
d2 - delay between relays 1 & 3

1. Trigger INPUT 1, INPUT 2, or 'WET'.
  - RELAY 1 will close and hold for time h 1.
  - RELAY 2 will close after time delay d l and hold for time h2.
  - RELAY 3 will close after time delay d2 and hold for time h3.
2. Trigger INPUT 3.
  - RELAY 1 will close and hold for time h 1.
  - INPUT 2 will be uninhibited for 5 seconds.

FUNCTION dN NOTE: INPUT 2 will only function if INPUT 4 is open.

## TEST

Upon completion of jumper settings, wiring, and programming, test the 8310-845 to ensure all function parameters are working correctly and as intended for the specific application.

## RELAY STATUS

STATUS	DESCRIPTION
r1	relay 1 closed when wired NO or open when wired NC
r2	relay 2 closed when wired NO or open when wired NC
r3	relay 3 closed when wired NO or open when wired NC
r=	relay 1 and relay 2 closed when wired NO or open when wired NC
r=	relay 1 and relay 3 closed when wired NO or open when wired NC
r=	relay 1, relay 2, and relay 3 closed when wired NO or open when wired NC

## FUNCTION CROSS REFERENCE

BR3 FUNCTION	BR3-X FUNCTION
21	22
25	28, 29, 36, or 37
35	36 or 37
75	28, 29, 36, or 37

## TROUBLESHOOTING

8310-845 will not react to any inputs	Incorrect power	Verify power supply of 12 – 24 VAC/VDC ±10% is wired to correct terminals
	Not programmed	Ensure a function is programmed, 8310-845 does not show 00, and all 'h' values are set to at least 01
	Incorrect wiring	Verify wiring is applied exactly as described for specific function programmed
	Defective	Replace
8310-845 has no output	Incorrect output devices	Ensure proper devices are connected to outputs for the specific function programmed
	Not programmed	Ensure a function is programmed, 8310-845 does not show 00, and all 'h' values are set to at least 01
	Incorrect wiring	Verify wiring is applied exactly as described for specific function programmed
	Incorrect jumper settings	Ensure all jumpers are configured correctly for specific application
	Defective	Replace
Output is constant/maintained	One or more of IN-1 through IN-4 have shorted	Resolve respective short
E1, E2, E3, E4, E5	EEPROM error	Reset and reprogram

## TECHNICAL SPECIFICATIONS

Supply Voltage	12 – 24 VAC/VDC $\pm$ 10%
Current Consumption	30 – 130 mA (DRY output)
Temperature Rating	-15 – 150 °F (-26 – 150 °C) If powered by AC voltage and using WET output to convert to DC voltage and current draw of device is greater than 0.9 A, the upper temperature range is 130 °F (54 °C)
Input	
Input 1, 2, 3, 4	DRY contact
WET input	5 – 24 VAC/VDC $\pm$ 10%
Contact Rating	
Relay 1 (DRY)	3 A @ 24 VAC or 30 VDC
Relay 1 (WET)	1 A
Relay 2	3 A @ 24 VAC or 30 VDC
Relay 3	1 A @ 24 VAC or 30 VDC
Dimensions	5.2" x 2.2" x 1" (133 mm x 55 mm x 25 mm)
Housing	ABS - white translucent

*Specifications are subject to change without prior notice.  
All values measured in specific conditions.*

### INSTALLATION/SERVICE COMPLIANCE EXPECTATIONS

The sensor manufacturer cannot be held responsible for incorrect installations or incorrect adjustments of the sensor/device; therefore, the sensor manufacturer does not guarantee any use of the sensor/device outside of its intended purpose.

The sensor manufacturer strongly recommends that installation and service technicians be AAADM-certified for pedestrian doors, IDA-certified for doors/gates, and factory-trained for the type of door/gate system.

Installers and service personnel are responsible for executing a risk assessment following each installation/service performed, ensuring that the sensor/device system performance is compliant with local, national, and international regulations, codes, and standards.

Once installation or service work is complete, a safety inspection of the door/gate shall be performed per the door/gate manufacturer's recommendations and/or per AAADM/ANSI/DASMA guidelines (where applicable) for best industry practices. Safety inspections must be performed during each service call – examples of these safety inspections can be found on an AAADM safety information label (e.g. ANSI/DASMA 102, ANSI/DASMA 107, UL294, UL325, and International Building Code).

Verify that all appropriate industry signage, warning labels, and placards are in place.



Do not leave problems unresolved. If a satisfactory solution cannot be achieved after troubleshooting a problem, please contact Allegion at 1-877-671-7011. If you must wait for the following workday to call Allegion, leave the door inoperable until satisfactory repairs can be made. Never sacrifice the safe operation of the automatic door or gate for an incomplete solution.

For more information, visit [www.allegion.com](http://www.allegion.com).



**LCN**

**ALLEGION®**

75.5954.03 ALLEGION 8310-845 20220727