



P516-270



CO-100

Offline lock user guide

Instructions for CO-Series offline locks

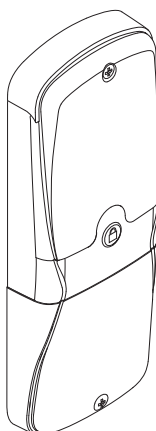
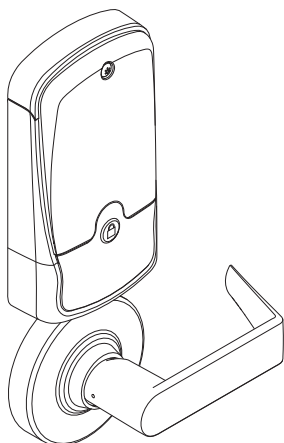
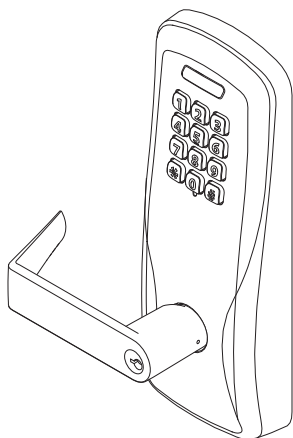

Para el idioma español, navegue hacia us.allegion.com.
Pour la portion française, veuillez consulter le site us.allegion.com.

Contents

Overview	3
Lock functions	4
Getting started	4
Construction access mode	4
Credential types and functions	5
Manual programming instructions	5
Important notes:	5
PROGRAMMING credential	5
NORMAL USE credentials	6
TOGGLE credentials	6
FREEZE credentials	6
PASS THROUGH credentials	6
OTHER programming	7
Error codes	8
Test lock operation	8
Mechanical test	8
Electronic test	8
Normal lock operation	8
Wired remote release feature	9
System requirements	9
Switch specifications, wire specifications and routing	9
Wired remote release operation	9
Wired remote release button action	9
Lock status reports	10
Reset to factory defaults	11
Batteries	12
To install or replace alkaline batteries	12
Low battery indications	12
Battery failure mode	13
LED reference	13
Schlage button	13
Optional Inside Push Button (IPB)	13
Troubleshooting	14
FCC Statements	15

This product is compliant of UL 294 and ULC-S319 standard. This product's compliance would be invalidated through the use of any add-on, expansion, memory or other module that has not yet been evaluated for compatibility for use with this UL Listed product, in accordance with the requirements of the Standards UL 294 and ULC-S319. This product has been evaluated for ULC-S319 Class I.

UL294 Access Control Levels tested to: Destructive Attack - Level 1; Line Security - Level 1; Endurance - Level 4; Standby Power - Level 1.

Overview

The Schlage CO-100 is a keypad-only off-line electronic lock in the CO-Series product line.

- This product is listed for UL 294 and ULC-S319.
- Three factory-configured functions are available: 1) Classroom/Storeroom, 2) Office, and 3) Privacy.
- The lock is powered by four (4) AA batteries. See *Batteries* on page 12 for more information.
- Outside lever is normally locked.
- Inside lever always allows egress.

Outside

Schlage Button

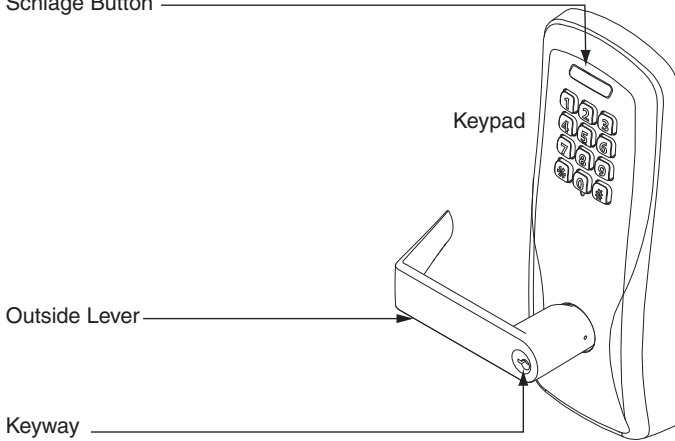

Inside

Battery Compartment

Optional Inside Push Button

Inside Lever

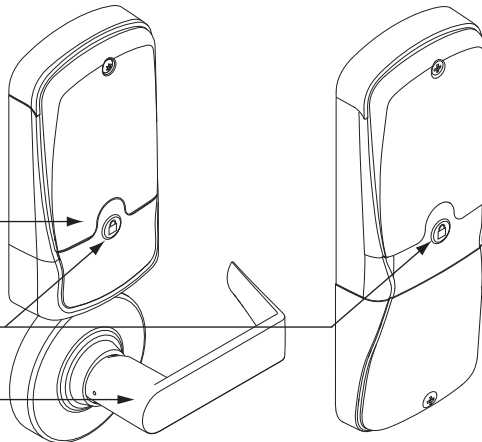

CO-100-CY
CO-100-MS

CO-100-993

Lock functions

The CO-100 lock is available in one of three functions:

Privacy (40): Privacy function is available on locks with firmware version 2.6.2 or higher. Lockset is normally secure. Inside Push Button is pressed to disable normal electronic access from outside (activates privacy). Another press of Inside Push Button restores normal electronic access (deactivates privacy).

Office (50): Lockset is normally secure. Inside Push Button may be used to select passage or secured status.

Classroom/Storeroom (70): Lockset is normally secure. Valid toggle credentials may be used to change to a passage or secure status.

Getting started

Follow these steps when setting up a new lock.

1. Install the lock. See the installation guide that came with the lock or visit us.allegion.com for more information.
2. Test the lock for proper mechanical and electronic operation. See *Test lock operation* on page 8 for more information.
3. When ready to set up for normal use, enter a new programming code, then program the user credentials. See *Manual programming instructions* on page 5.
4. Familiarize yourself with the information in this guide.

Save this user guide for future reference.

Construction access mode

Construction access mode is used to allow access before the lock has been programmed, and for testing purposes. Construction access mode is enabled by default.

Offline locks with keypads have a default PIN of 13579 and "#", which can be used for installation, testing and construction access.

- To test, enter the default PIN (13579 and "#").
- The Schlage button will blink and the lock will unlock.
- The default PIN is automatically deleted when a new programming credential is created.

TIP

If you press the default PIN code on a new lock and the code is not accepted, the lock has already been programmed.

If the new PIN is not known, or to put the lock back into construction access mode, reset the lock to factory settings. See *Reset to factory defaults* on page 11 for more information.

Credential types and functions

Programming credential: A 5 digit code used only for lock programming.

PIN credential: A 3-6 digit code entered on the keypad.

Note: A unique credential must be used for each credential type described below (for example, a single credential may not be used for both normal use and toggle functions).

Credential type	Function
Programming PIN	Used <u>only to program</u> the lock. Does not unlock the lock.
Normal use PIN	Unlocks the lock <i>momentarily</i> after a credential is entered.
Toggle PIN	Changes the state of the lock from locked (secured) to unlocked (unsecured), or vice versa, unless in a Freeze state.
Freeze PIN	Freezes the lock in the current state. The lock remains frozen until any Freeze credential is entered again. (A pass-through credential will override a lock in frozen state as described below).
Pass-through PIN	Unlocks a lock <i>momentarily</i> , regardless of state. A valid Pass-through credential can unlock a door set to any secured lockout mode (e.g., Freeze, Privacy, Time Zones, Door Auto-Locks and Holidays). The door will relock after the specified relock time.

Manual programming instructions

Important notes:

- ❶ Wait for the Schlage button LEDs to stop flashing before continuing to the next step.
- ❶ Programming mode will time out if no entry is made in 20-25 seconds. Time out is indicated by three left and nine right red blinks of the Schlage button.
- ❶ An incorrect entry is indicated by a solid red left and blinking green right LED on the Schlage button. Refer to *Error codes* on page 8 to interpret error code patterns.
- ❶ A unique PIN must be used for each credential type (for example, a single PIN may not be used for both normal use and toggle functions).

PROGRAMMING credential

To complete this action:	Perform the following steps:			
	Wait for  to stop flashing between each step!			
	1	2	3	4
Create new Programming Code (PIN)	Enter ⑨ ⑦ ⑤ ③ ① * (This is the default programming PIN)	Enter ⑦ *	Enter new 5 digit Programming code and * Wait for right green light.	Reenter the new 5 digit Programming code and * Wait for confirmation: 2 right green blinks.

Note: Programming codes such as 1-1-1-1-1 or 1-2-3-4-5 can be easily selected by non-authorized users and should not be used.

NORMAL USE credentials

Note: Until a new Normal Use PIN is created, the default PIN is **1 3 5 7 9 #**

To complete this action:	Perform the following steps:					
	Wait for  to stop flashing between each step!					
	1	2	3	4	5	6
Create a Normal Use PIN	Enter Programming PIN and *	Enter 3 *	Enter new 3-6 digit PIN and **	For another PIN, go back to step 3	Press * again to finish	Wait for confirmation: 2 right green blinks.

TOGGLE credentials

To complete this action:	Perform the following steps:					
	Wait for  to stop flashing between each step!					
	1	2	3	4	5	6
Create a Toggle PIN	Enter Programming PIN and *	Enter 3 3 *	Enter 1 9 1 *	Enter new 3-6 digit PIN and ** Wait for right green light.	For another PIN, go back to step 4 OR press * again to finish	Wait for confirmation: 2 right green blinks.





























































FREEZE credentials

To complete this action:	Perform the following steps:					
	Wait for  to stop flashing between each step!					
	1	2	3	4	5	6
Create a Freeze PIN	Enter Programming PIN and *	Enter 3 3 *	Enter 1 1 5 *	Enter new 3-6 digit PIN and ** Wait for right green light.	For another PIN, go back to step 4 OR press * again to finish	Wait for confirmation: 2 right green blinks.

PASS THROUGH credentials

To complete this action:	Perform the following steps:					
	Wait for  to stop flashing between each step!					
	1	2	3	4	5	6
Create a Pass Through PIN	Enter Programming PIN and *	Enter 3 3 *	Enter 1 1 9 *	Enter new 3-6 digit PIN and ** Wait for right green light.	For another PIN, go back to step 4 OR press * again to finish	Wait for confirmation: 2 right green blinks.

OTHER programming

To complete this action:	Perform the following steps:				
	Wait for  to stop flashing between each step!				
	1	2	3	4	5
Delete a PIN	Enter Programming PIN and 	Enter  	Enter the PIN to be deleted and 	To delete another PIN, go back to step 3 OR press  again to finish	Wait for confirmation: 2 right green blinks.
Change PIN length (Available with firmware version 2.5.0 or higher.)	Enter Programming PIN and 	Enter   	Enter  	Enter  ,  ,  , OR  for desired PIN length	Press  again to finish Wait for confirmation: 2 right green blinks.
Change relock delay period	Enter Programming PIN and 	Enter   	Enter  	Each button press adds to the total delay time Example:  +  adds a 10 second delay	Press  again to finish Wait for confirmation: 2 right green blinks.
Disable/enable beeper	Enter Programming PIN and 	Enter   	Enter  	Enter   to disable beeper OR   to enable beeper	Press  again to finish Wait for confirmation: 2 right green blinks.
Disable/enable remote release feature	Enter Programming PIN and 	Enter   	Enter  	Enter   to disable remote release OR   to enable remote release	Press  again to finish Wait for confirmation: 2 right green blinks.
Disable/enable occupancy indicator feature	Enter Programming PIN and 	Enter   	Enter  	Enter   to disable occupancy indicator blinks OR   to enable occupancy indicator fast blinks OR   to enable occupancy indicator slow blinks	Press  again to finish Wait for confirmation: 2 right green blinks.

Error codes

- ① All error codes are indicated on the Schlage button by a **solid red left LED**, and a **blinking green right LED**. The number of green blinks indicates the error code.

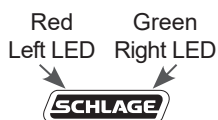

Number of green blinks	Error code description
2	Too long programming/user code entered. Programming code must be five (5) digits. User code length cannot exceed six (6) digits.
3	Memory full, too many codes. Delete some codes.
4	Programming code cannot be deleted, only changed.
5	Programming code entries do not match. Programming code not changed.
6	Invalid command. Invalid function code entered.
7	Code not found.
8	Code too short. Programming code length must be five (5) digits. User code minimum length is three (3) digits.
9	Not a unique code.

Error code functions have not been verified by Underwriters Laboratories Inc.

Test lock operation

If you encounter problems while performing any of the following tests, review the installation guide and correct any problems.

Mechanical test

1. Rotate the inside lever or depress the push bar to open the door. Operation should be smooth, and the latch should retract.
2. Insert the key into the keyway and rotate the key and the outside lever to open the door. Operation should be smooth, and the latch should retract.

Electronic test

1. Press any number key. The lock will beep. Use the default PIN (13579 and "#") to verify access.

Normal lock operation

After PIN credentials have been programmed, enter a PIN to operate the lock:

Press a valid PIN. The green LED will blink and access is granted.

The "#" key is used as ENTER key for PINs with fewer than six digits. Default minimum digits is six (6). PIN length may be manually configured so users do not have to push the "#" key (see *Change PIN length* on page 7).

If the PIN credential is entered incorrectly, press "*" to start over.

Wired remote release feature

System requirements

- Available on CO-100 Office function only.
- The CO-100 must be programmed with CO-100 version 2.6.2 firmware or higher.

Switch specifications, wire specifications and routing

- Recommended switch: basic SPST (single-pole single-throw) momentary action switch with normally open contact configuration.
- Wire gauge AWG 24, stranded, twisted pair, shielded. (Shielded cable is optional. If shield is present, only one end of the cable shield should be terminated to chassis ground).
- Belden 9841 or equivalent.
- Maximum cable length is 1000 feet (305 meters).
- Route wires from the switch, through the door frame and door to the door position switch terminals as shown below.

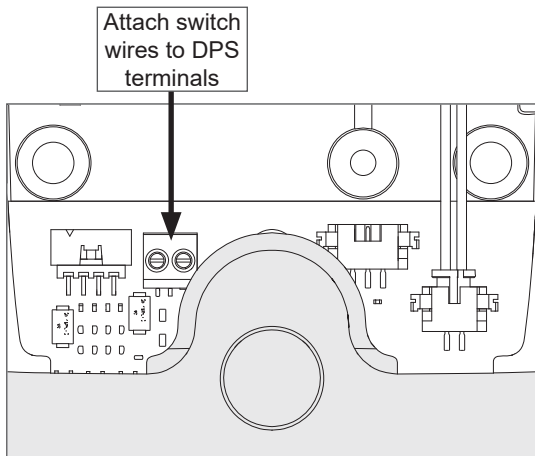

Wired remote release operation

- When the remote release button is pressed the lock will unlock for the programmed relock delay period. The green Schlage LEDs and the green inside push button LED will turn on to indicate the lock is unlocked. If the beeper function is turned on, the beeper will sound one time to indicate the lock is unlocked.
- After the relock delay period has expired, the green Schlage LEDs and the green inside push button LED will turn off. If the beeper function is turned on, the beeper will sound two times to indicate the lock is relocked.

Wired remote release button action

- If the remote release button is pressed and held, the release will function only one time, even in the event the button is held longer than the relock delay period.
- If the remote release button is quickly pressed repeatedly, the release will function only one time. Any additional button presses during the relock delay period are ignored.
- Once the lock relocks, the next press of the remote release button will activate a new release cycle.

Lock status reports

Follow the steps below to obtain lock status reports:

- ① **Lock status reporting is available with firmware version 2.5.0 or higher.**
- ① **The left and right Schlage button LEDs will blink red once with each button press, followed by the status indicator as described below.**

Function / Report	Press	Indicator/Report result
Initiate report mode	Press and hold  while pressing ⑨ ⑨ #	Wait until only the right Schlage button LED is on to indicate the lock is in report mode and awaiting an entry. If no entry is made, then timeout will occur in 20 seconds.
Battery status	①	Left LED: Solid green = normal Blinking red = low No indicator = critical battery

Once a status is reported, both left and right LEDs will light green, followed by solid green on the right LED only. The right green LED indicates the lock is awaiting another entry.

Obtain an additional status report as described below, or press * to exit report mode.

Function / Report	Press	Indicator/Report result
Firmware status	③	Left LED blinks green for the version number
Hardware status	④	Decimal point is indicated by one red blink “Zero” is indicated by two red blinks
PCB serial number	⑥	Left LED blinks green for each number Each number is separated by one red blink Press # after two red blinks to display the next number

If no entry is made within 20 seconds of the solid green right LED, then timeout will occur.

To exit report mode at any time, press *.

Reset to factory defaults

All information in the main controller in the lock will be deleted and reset to factory defaults!

Main controller configurations that will reset to factory default include: programming and user codes.

The door must be locked (not toggled open or in the middle of normal access) before resetting to factory defaults.

Follow these steps to reset to factory defaults.

1. Remove the top inside cover.
2. Remove one battery from the battery pack to disrupt power. Wait 5 to 10 seconds for power to run out in the lock.
3. Press and hold the Schlage button while reconnecting the battery into the battery pack to resupply power.
4. Continue holding the Schlage button, and wait for two beeps to sound and two green blinks of the Schlage button.
5. Release the Schlage button.
6. Press and release the Schlage button three (3) times within 10 seconds of the beeps and blinks at step 4. One beep will sound and one red blink will occur with each press.
7. The Schlage button will light green for one second and a one-second beep will sound, indicating that the lock has been reset.

① **If the Schlage button is not pressed 3 times within 10 seconds, two beeps and two red blinks indicate timeout.**

8. Replace the top inside cover.

To test, enter 13579 and "#". The Schlage button will blink and the lock will unlock momentarily.

Batteries

To install or replace alkaline batteries

① **Changing batteries does not affect any programmed data.**

1. Remove the battery cover.
2. Remove the battery bracket. Do not allow the battery pack to hang from the wires.
3. Install the new batteries (install only new AA Alkaline batteries). Make sure the batteries are installed in the correct orientation.
4. Reinstall the battery pack and battery bracket.
5. Reinstall the battery cover, making sure the plug is to the right of the battery pack (CY, MS, and MD locks). **Be careful not to pinch the battery wires when installing the battery cover.**

CAUTION! Danger of explosion if batteries are incorrectly replaced! Replace only with new AA alkaline batteries. Dispose of used batteries according to the manufacturer's instructions.

This product has been evaluated for ULCS319 compliance with AA batteries listed below. For installations requiring ULCS319, these battery models should be used.

Duracell PC1500, MN1500; Energizer E91, EN91, AX91, XR91; RayoVac 815, 815-HE

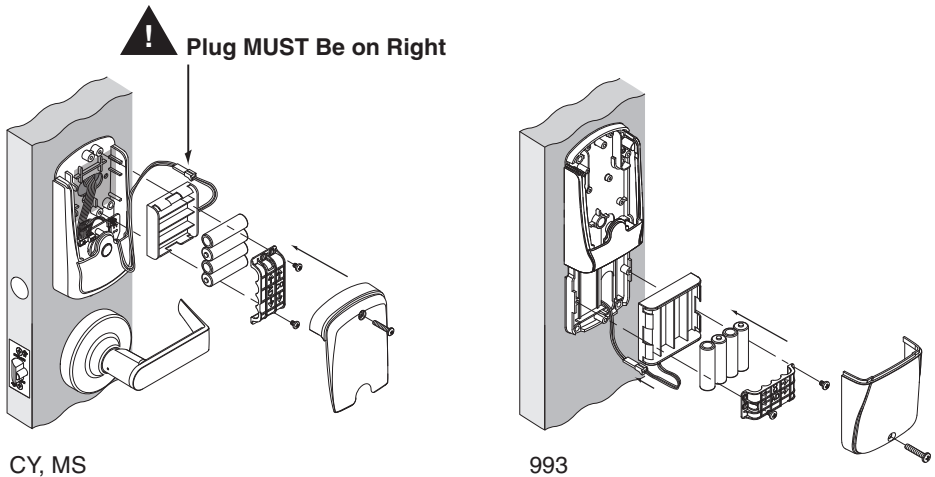

Low battery indications

Condition	Indicator	Solution
Batteries low	After credential PIN is pressed, 9 red blinks of Schlage button, then normal indicator.	Replace batteries immediately to avoid battery failure. Lock is intended to operate for 500 cycles in low battery condition.
Battery failure	No LED or beeps Valid credentials do not grant access	Replace batteries immediately. Mechanical override key must be used to unlock the lock.

Battery failure mode

In the event of battery failure, the lock will fail As-Is (lock remains in current state, locked or unlocked, until batteries are replaced).

LED reference

Schlage button

Condition	Lights
Access denied	2 red blinks
Valid PIN entered while lock in Freeze mode	12 red blinks indicating lockout
Factory default reset	One-second solid green with one-second beep
Low battery indicator, AA batteries	9 left red blinks
Momentary unsecured access	1 green blink, then one red blink on relock
Occupancy indicator fast blinks are enabled	1 red blink every 1.5 seconds*
Occupancy indicator slow blinks are enabled	Sequential 1 red blink on both left and right every 1.5 seconds*

* The red blinks will turn amber for occupancy indicator when the lock's battery is low.

Optional Inside Push Button (IPB)

Action	Lights
Office Mode	
Press IPB to lock	1 red blink
Press IPB to unlock ¹	1 green blink
Privacy Mode	
With door closed, press IPB to engage privacy	4 green blinks
With door closed, press IPB to release privacy	4 red blinks

Condition	Lights
Occupancy Indicator Feature	
Occupancy indicator blinks fast mode/slow mode	1 red blink every 3 seconds*

¹ Unlocking the lock with the IPB will cause the lock to remain unlocked until the IPB is depressed again.

* The red blinks will turn amber for occupancy indicator when the lock's battery is low.

Troubleshooting

Problem	Possible cause	Solution
<p>The lock does not function when a valid PIN credential is entered, or the lock beeper does not sound.</p>	<p>The beeper may be turned off.</p> <p>The battery or wired power may be improperly connected.</p> <p>The batteries may be inserted with incorrect polarity.</p> <p>The batteries may be depleted.</p> <p>If applicable, the IPB through-door ribbon cable may not be properly plugged in, or may have bent pins.</p>	<p>Use manual programming to enable the beeper (see <i>Disable/enable beeper</i> on page 7).</p> <p>Check that the battery or wired power is connected correctly.</p> <p>Check that batteries are inserted in the correct polarity.</p> <p>Replace batteries.</p> <p>Check that the optional IPB through-door ribbon cable is plugged in correctly (if applicable). The red wire should be on the left and not pinched in the door.</p> <p>Check that there are no bent pins on the optional IPB through-door cable.</p> <p><i>Refer to the installation instructions that came with the CO-100 lock, or this user guide for details on the above mentioned procedures.</i></p>
<p>Wired remote release feature is not working.</p>	<p>The lock may not be compatible with remote release.</p> <p>The firmware version may not be compatible with remote release.</p> <p>The remote release switch may not be functioning correctly.</p>	<p>Wired remote release is available only on the CO-100 Office function.</p> <p>Wired remote release is compatible with locks programmed with CO-100 version 2.6.2 firmware or higher.</p> <p>Check that the switch closes and delivers less than 5 ohms resistance when activated.</p>

FCC Statements



This device complies with Part 15 of the FCC Rules. Operation is subject to the following two conditions:

1. this device may not cause harmful interference, and
2. this device must accept any interference received, including interference that may cause undesired operation.

Customer Service

1-877-671-7011 www.allegion.com/us



© Allegion 2020
Printed in U.S.A.
P516-270 Rev. 03/20-L