

VON DUPRIN®



# 78 & 75 Series

Exit Devices

# Contents

<b>Introduction .....</b>	<b>2</b>	<b>Electrified options .....</b>	<b>35</b>
<b>How to order .....</b>	<b>5</b>	Latch retraction .....	35
<b>Device types .....</b>	<b>6</b>	Switches.....	36
78 Rim exit.....	8	Alarm kit.....	37
78-F Fire-rated rim exit.....	9	Electrified trim .....	38
7827 Surface mounted vertical rod.....	10	Power supplies.....	39
7827-F Fire-rated surface mounted vertical rod .....	11	Electrical power and pneumatic transfers.....	41
7847 Concealed vertical rod.....	12	Allegion Connect .....	42
7847-F Fire-rated concealed vertical rod.....	13	<b>Accessories.....</b>	<b>43</b>
75 Rim exit device.....	14	Strikes .....	43
75-F Fire-rated rim exit.....	15	Door kits .....	45
7527 Surface mounted vertical rod.....	16	Sex bolts.....	46
7527-F Fire-rated surface mounted vertical rod .....	17	Mullions.....	47
7547 Concealed vertical rod.....	18	Steel and aluminum mullions .....	48
7547-F Fire-rated concealed vertical rod.....	19	<b>Additional information .....</b>	<b>49</b>
<b>Trim options .....</b>	<b>20</b>	UL listing for fire exit hardware.....	49
<b>Mechanical options .....</b>	<b>30</b>	ANSI function, grade and type .....	50
Dogging options.....	30	Stile information .....	51
Weatherized options .....	31	Decorative levers .....	54
Accessibility options .....	32	Standard levers.....	55
Latches .....	33	Device finish options .....	56

## Customer Service

US: 877-671-7011, Option 1  
 CAN: 800-900-4734  
 Support@Allegion.com

## Technical Support

877-671-7011, Option 2  
 Exits\_TechProdSupport@Allegion.com  
 YouTube.com/VonDuprinSafety

## Ordering

Allegion\_Orders@Allegion.com  
 eFax: 800-999-0328



# PUSHING FORWARD™

Over a century ago, Von Duprin invented the first self-releasing fire exit device. Today we continue to push the envelope by delivering innovative solutions to challenging applications. Our durable panic and exit door hardware products are proven to perform and are backed by a team of experts. We provide flexible solutions and modular options to protect your investment well into the future.



## Quality

Von Duprin leads the industry with durable solutions that are proven in the field to perform under heavy use and abuse and backed by a team of experts experienced in door hardware application and code compliance.



## Flexibility

Von Duprin empowers you to embrace change by providing flexible solutions that can be modified over time as new trim, functions or other options are required, protecting your investment well into the future.



## Trust

Von Duprin designed the first self-releasing fire exit device more than a century ago and continues to advance fire and life safety, with innovation and best-in-class support to address your most challenging applications with code compliant solutions.

# Mid-Priced, But Beyond Expectations

Enjoy the quality and trust you expect from Von Duprin at a mid-price option. Von Duprin 70 Series exit devices provide reliable performance and peace of mind for applications like warehouse, industrial, office, multifamily, retail, and commercial real estate spaces. It's available in a wide range of device types, lever designs, options, and finishes.

Von Duprin's 70 Series also can be configured with the Quiet Electric Latch Retraction (QEL) option, which provides electronic control of an exit device where limited operational noise is desired. Plus, quick shipping is an option for time-sensitive projects.

## 78 & 75 SERIES

Von Duprin exit devices are available as two device stiles, the 78 and the 75 Series.

### 78 Series is a Wide Stile Device

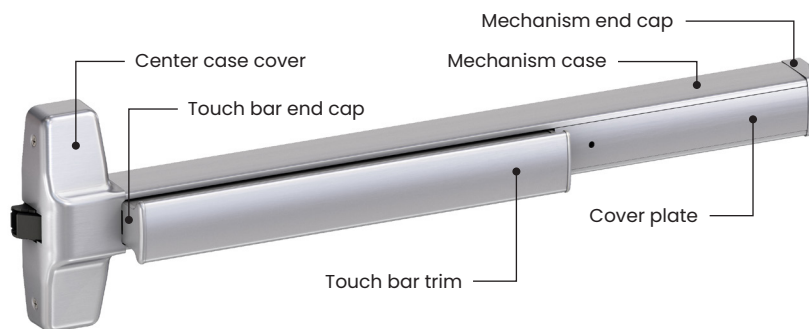

### 75 Series is a Narrow Stile Device

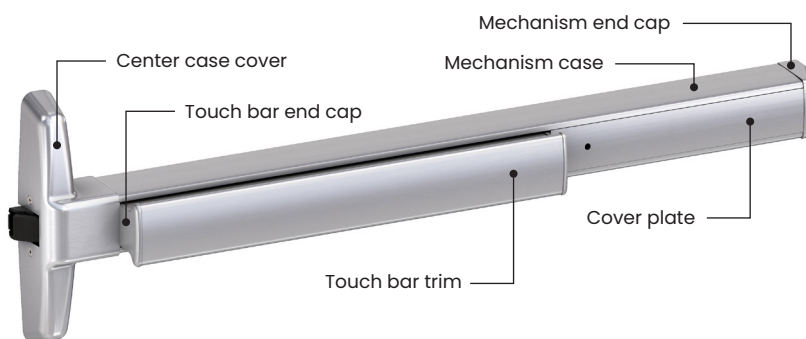

### Latch Bolt

Deadlocking latch bolt provides security and improved performance at standard device cost.



## How to order

## NOMENCLATURE – HOW TO ORDER

Prefix	Device Series/Type		Trim/Rating		Suffix Finish		Door Width	Handing	Less Bottom Rod	Trim Options/Finish	Accessories	Other Information
1	2	3	4	5	6	7	8	9	10	11	12	13
QEL	78	- 27	L	- F	-	- 626	3'	RHR	LBR	780-06/626	SNB	HM

Standard options are indicated with a dot. See price book for specific configuration options.

<b>1 Prefixes</b>		<b>5 Rating</b>		<b>10 Less Bottom Rod</b>	
None	Standard	F	Fire exit hardware	LBR	Less bottom rod
AX	Accessible device	Blank	Panic exit hardware	LBR-AFL	LBR with fire pin
CD	Cylinder dogging - panic only	<b>6 Suffix</b>		<b>11 Trim Options/Finish</b>	
LD	Less dogging	CON	Connectors	See trim options/ finish for each device type	
LX	Latch bolt monitoring	WH	Weep holes	Lever style 06 standard default (optional levers available)	
QEL	Quiet electric latch retraction	ALK	Alarm exit kit	<b>12 Accessories</b>	
RX	Request to exit	<b>7 Finish</b>		CYL	Cylinder
<b>2 Device Series</b>		605	Bright brass	GBK	Glass bead kit
78	Series 78 Wide Stile	606	Satin brass	SEC	Security screws
75	Series 75 Narrow Stile	612	Satin bronze	SNB	Sex bolts
<b>3 Device Type</b>		619	Satin nickel	<b>13 Other information</b>	
None	Rim device	625	Bright chrome	<b>Miscellaneous</b>	
27	Surface mounted vertical rod device	626	Satin chrome	CE	CE labeled
47	Concealed vertical rod device	628	Aluminum, anodized	LCP	Less cover plate
<b>4 Trim Functions</b>		630	Satin stainless	10WDA	#10WDA cover plate
DT	Dummy trim	643e	Aged bronze	<b>Door material</b>	
EO	Exit only*	710	Dark brown, anodized	AL	Aluminum door
L	Lever (classroom)	711	Matte black	HM	Hollow metal
L-BE	Lever - blank escutcheon	<b>8 Door Width</b>		WD	Wood door
L-DT	Lever, rigid - dummy trim	3'	Std default	1-3/4"	Std
L-NL	Lever, rigid - night latch	4'		2-1/4"	Optional
NL	Night latch	<b>9 Handing</b>		CP	Composite door
NL-OP	Night latch cylinder assembly, optional pull	LHR	Left hand reverse	<b>Door application</b>	
TL	Turn lever	RHR	Right hand reverse	D	Double egress
TL-BE	Turn lever - blank escutcheon			P	Pair of doors
				S	Single door

\* For AD or CO locks, order the panic as Exit Only (EO).

## Device types

# Device Types

As the pioneer in the industry, Von Duprin continues to advance the industry through customer-centric innovation, which delivers solutions to the most challenging applications.

Backed by high quality standards, Von Duprin exit devices were among the first in the industry certified to ANSI/BHMA A156.3 (2014) Grade 1. Our exit devices are tested to the highest standards and proven in the field to perform under heavy use and abuse, giving you peace of mind both now and in the future.

The versatile design can be easily upgraded to connect to a larger electronic ecosystem, empowering you to adapt with flexible solutions. You can configure numerous variations in the field without replacing your device and protecting your investment. This makes upgrades easy and cost effective.

## POPULAR APPLICATIONS

### Single Door Applications

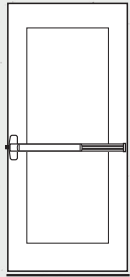

Single rim device

### Double Door Applications

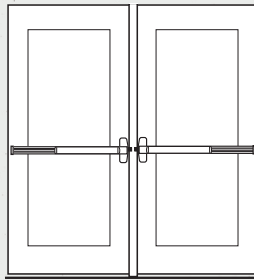

Two rim devices with mullion—same direction

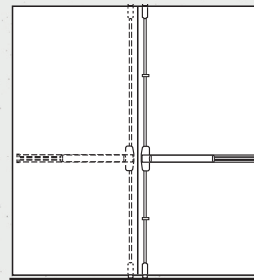

Two vertical rods—double egress  
Two surface/concealed rods

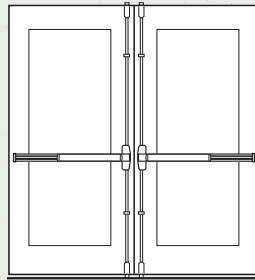

Two surface mounted vertical rod devices—same direction\*

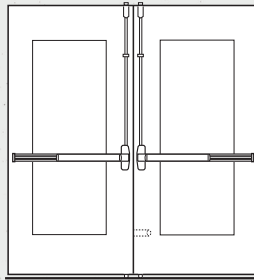

Two fire exit hardware vertical rods with auxiliary fire latch—LBR option\*

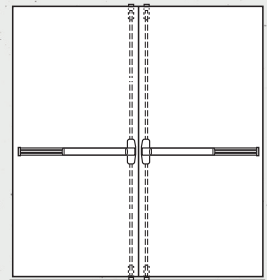

Two concealed vertical rods—same direction\*

\* Do not use with overlapping astragal

## Door Handing

Left hand-reverse orientation

Right hand-reverse orientation

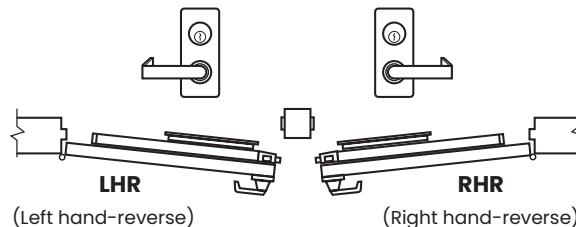

(Left hand-reverse)

(Right hand-reverse)

Outside





204

BANQUET HALL

204

1 1/2"



## Device types

# 78 Rim Exit Device



78 Rim exit devices for all types of single and double doors with mullion, UL listed for panic exit hardware. Devices are certified to ANSI/BHMA A156.3 2014, Grade 1. Covers stock hollow metal doors with 86 or 161 cutouts on single doors (may cover cutouts on pairs – consult template).

Specifications	Details
Device functions	Device ships EO/DT/NL; Field selectable; For L remove NL drive screw from device
Device lengths	3' 2' 6" to 3' (762mm to 914mm) door size 4' 3' to 4' (914mm to 1219mm) door size
Device centerline from finished floor	39-13/16" (1011mm) 39-11/16" (1008mm) with mullion
Center case	7-7/8" x 2-3/4" x 2-3/8" (200mm x 70mm x 60mm)
Mechanism case	2-5/16" x 2-1/8" (59mm x 54mm)
Projection	Pushbar neutral - 3-13/16" (97 mm) Pushbar depressed - 3-1/16" (78mm)
Latch bolt	Deadlocking, 5/8" (15.875mm) throw
Finishes	US26D (626), US28 (628), 313 (710), US4 (606), US3 (605), US15 (619), US26 (625), 315 (711), 643E
Pushbar length	3' 18" (457mm) 4' 24" (610mm)
Fasteners and sex bolts (SNB)	Includes screw pack for 1-3/4" (4mm) and 2-1/4" (57mm) thick metal or wood doors (Optional 425 SNB available)

## Features & Options

### Electrified Options

LX	Latch bolt monitor switch
RX	Request to exit
E	Electric locking and unlocking trim
ALK	Alarm exit kit
CON	Allegion Connect
QEL	Quiet electric latch retraction

### Mechanical Options

AX	Accessible device
GBK	Glass bead kit
SNB	Sex bolts
SEC	Security screws
WH	Weep holes

### Dogging Feature

Hex key dogging standard

### Dogging Options

CD	Cylinder dogging
LD	Less dogging
QEL	QEL options available

### Strike

299	Dull black
-----	------------

## Accessories



### 299 Strike

Ships standard, optional strikes available.



### Hex key dogging

Comes standard on 78 panic exit device



# 78-F Fire-Rated Rim Exit Device



78-F Rim fire exit devices are certified to ANSI/BHMA A156.3 2014, Grade 1 and UL listed for fire exit hardware. [See UL fire exit hardware](#) label and door opening size information within this catalog.

Specifications	Details
Device functions	Device ships EO/DT/NL; Field selectable; For L remove NL drive screw from device
Device lengths	3' 2' 6" to 3' (762mm to 914mm) door size 4' 3' to 4' (914mm to 1219mm) door size
Device centerline from finished floor	39-13/16" (1011 mm) 39-11/16" (1008mm) with mullion
Center case	7-7/8" x 2-3/4" x 2-3/8" (200mm x 70mm x 60mm)
Mechanism case	2-5/16" x 2-1/8" (59mm x 54mm)
Projection	Pushbar neutral - 3-13/16" (97mm) Pushbar depressed - 3-1/16" (78mm)
Latch bolt	Deadlocking, 5/8" (15.875mm) throw
Finishes	US26D (626), US28 (628), 313 (710), US4 (606), US3 (605), US15 (619), US26 (625), 315 (711), 643E
Pushbar length	3' 18" (457mm) 4' 24" (610mm)
Fasteners and sex bolts (SNB)	Includes screw pack for 1-3/4" (4mm) and 2-1/4" (57mm) thick metal or wood doors (Optional 425 SNB available)

## Features & Options

Electrified Options	
LX	Latch bolt monitor switch
RX	Request to exit
E	Electric locking and unlocking trim
ALK	Alarm exit kit
CON	Allegion Connect
QEL	Quiet electric latch retraction

Mechanical Options	
AX	Accessible device
GBK	Glass bead kit
SNB	Sex bolts
SEC	Security screws
WH	Weep holes

Dogging Options	
	No mechanical dogging

Strikes	
299F	Dull black
499F	Strike with mullions

## Accessories



**299F Strike**  
Ships standard, optional strikes available



**499F Strike**  
With 9854/9954 mullion

## Device Types

# 7827 Surface Mounted Vertical Rod Device

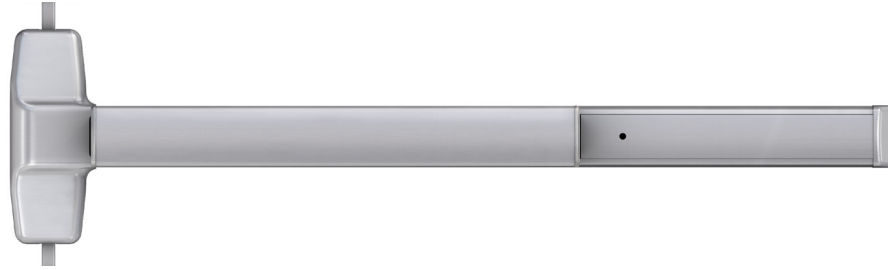

7827 Surface mounted vertical rod device for all types of single or double doors, UL listed for panic exit hardware. Devices are certified to ANSI/ BHMA A156.3 2014, Grade 1. Covers stock hollow metal doors with 86 or 161 cutouts. Vertical rod and latch guards are available to protect the bottom rod of the exit device from damage by impacts of carts or gurneys passing through doors.

Specifications	Details
Device functions	Device ships EO/DT/NL; Field selectable; For L remove NL drive screw from device
Device lengths	3' 2' 6" to 3' (762mm to 914mm) door size 4' 3' to 4' (914mm to 1219mm) door size
Device centerline from finished floor	39-13/16" (1011mm) 39-11/16" (1008mm) with mullion
Center case	7-7/8" x 2-3/4" x 2-3/8" (200mm x 70mm x 60mm)
Mechanism case	2-5/16" x 2-1/8" (59mm x 54mm)
Projection	Pushbar neutral - 3-13/16" (97 mm) Pushbar depressed - 3-1/16" (78mm)
Latch bolt	Deadlocking, 5/8" (15.875mm) throw
Finishes	US26D (626), US28 (628), 313 (710), US4 (606), US3 (605), US15 (619), US26 (625), 315 (711), 643E
Pushbar length	3' 18" (457mm) 4' 24" (610mm)
Fasteners and sex bolts (SNB)	Includes screw pack for 1-3/4" (4mm) and 2-1/4" (57mm) thick metal or wood doors (Optional 425 SNB available)

## Accessories



**299**  
Top strike



**Top latch**



**Hex key dogging**  
Comes standard on 78 panic exit device



**248L4**  
Bottom strike  
For use with flat threshold



**Bottom latch**



**304L Bottom strike**

## Features & Options

### Electrified Options

LX	Latch bolt monitor switch
RX	Request to exit
E	Electric locking and unlocking trim
ALK	Alarm exit kit
CON	Allegion Connect
QEL	Quiet electric latch retraction

### Mechanical Options

AX	Accessible device
GBK	Glass bead kit
LBR	Less bottom rod
SNB	Sex bolts
SEC	Security screws
WH	Weep holes

### Dogging Feature

Hex key dogging standard

### Dogging Options

CD	Cylinder dogging
LD	Less dogging
QEL	QEL options available

### Strikes

299	Top—Dull black
248L4 & 304L	Bottom—Unfinished



# 7827-F Fire-Rated Surface Mounted Vertical Rod Device

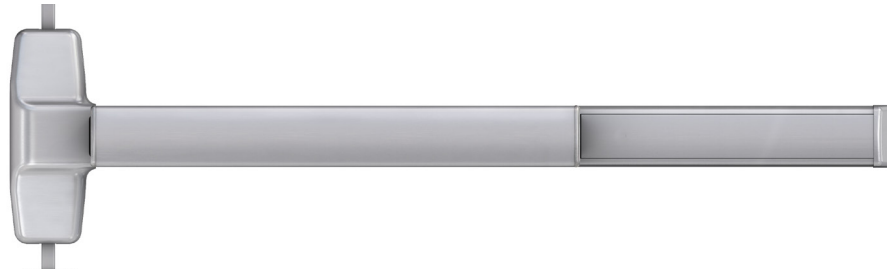

7827-F Fire exit surface mounted vertical rod device are certified to ANSI/BHMA A156.3 2014, Grade 1 and UL listed for fire exit hardware. [See UL fire exit hardware](#) label and door opening size information within this catalog. Vertical rod and latch guards are available to protect the bottom rod of the exit device from damage by impacts of carts or gurneys passing through doors. Rod and latch guards can be used on hollow metal or tin clad composite fire doors.

Specifications	Details
Device functions	Device ships EO/DT/NL; Field selectable; For L remove NL drive screw from device
Device lengths	3' 2' 6" to 3' (762mm to 914mm) door size 4' 3' to 4' (914mm to 1219mm) door size
Device centerline from finished floor	39-13/16" (1011mm) 39-11/16" (1008mm) with mullion
Center case	7-7/8" x 2-3/4" x 2-3/8" (200mm x 70mm x 60mm)
Mechanism case	2-5/16" x 2-1/8" (59mm x 54mm)
Projection	Pushbar neutral - 3-13/16" (97 mm) Pushbar depressed - 3-1/16" (78mm)
Latch bolt	Deadlocking, 5/8" (15.875mm) throw
Finishes	US26D (626), US28 (628), 313 (710), US4 (606), US3 (605), US15 (619), US26 (625), 315 (711), 643E
Pushbar length	3' 18" (457mm) 4' 24" (610mm)
Fasteners and sex bolts (SNB)	Includes screw pack for 1-3/4" (4mm) and 2-1/4" (57mm) thick metal or wood doors (Optional 425 SNB available)

## Features & Options

Electrified Options	
LX	Latch bolt monitor switch
RX	Request to exit
E	Electric locking and unlocking trim
ALK	Alarm exit kit
CON	Allegion Connect
QEL	Quiet electric latch retraction

Mechanical Options	
AX	Accessible device
GBK	Glass bead kit
LBR	Less bottom rod
SNB	Sex bolts
SEC	Security screws
WH	Weep holes

Dogging Options	
	No mechanical dogging

Strikes	
299F & 499F LBR	Top—Dull black
304L	Bottom, Dull black, Unfinished

## Accessories

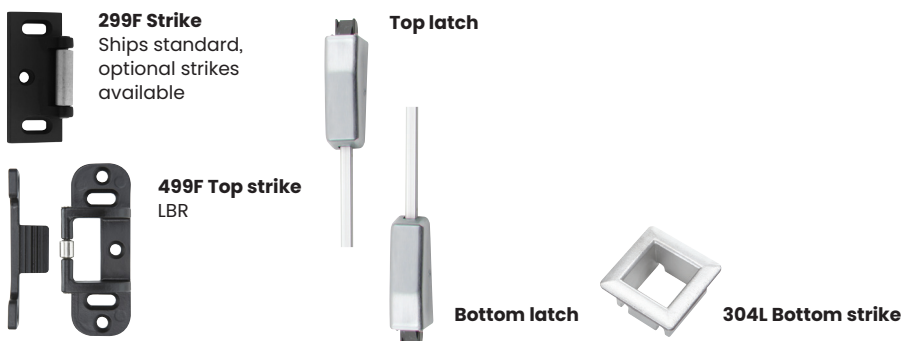

## Device Types

# 7847 Concealed Vertical Rod Device

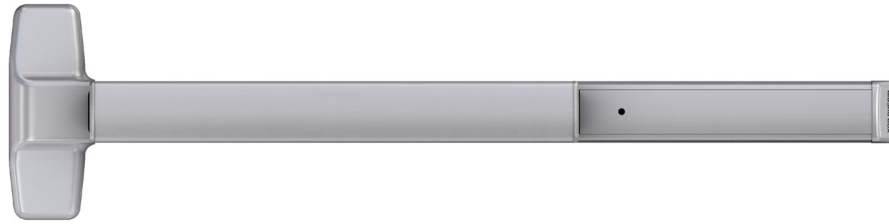

7847 Concealed vertical rod device for use on single or double metal doors, UL listed for panic exit hardware. These are certified to ANSI/BHMA A156.3 2014, Grade 1.

Specifications	Details
Device functions	Device ships EO/DT/NL; Field selectable; For L remove NL drive screw from device
Device lengths	3' 2' 6" to 3' (762mm to 914mm) door size 4' 3' to 4' (914mm to 1219mm) door size
Device centerline from finished floor	39-13/16" (1011mm) 39-11/16" (1008mm) with mullion
Center case	7-7/8" x 2-3/4" x 2-3/8" (200mm x 70mm x 60mm)
Mechanism case	2-5/16" x 2-1/8" (59mm x 54mm)
Projection	Pushbar neutral - 3-13/16" (97mm) Pushbar depressed - 3-1/16" (78mm)
Latch bolt	Deadlocking, 5/8" (15.875mm) throw
Finishes	US26D (626), US28 (628), 313 (710), US4 (606), US3 (605), US15 (619), US26 (625), 315 (711), 643E
Pushbar length	3' 18" (457mm) 4' 24" (610mm)
Fasteners and sex bolts (SNB)	Includes screw pack for 1-3/4" (4mm) and 2-1/4" (57mm) thick metal or wood doors (Optional 425 SNB available)

## Features & Options

### Electrified Options

LX	Latch bolt monitor switch
RX	Request to exit
E	Electric locking and unlocking trim
ALK	Alarm exit kit
CON	Allegion Connect
QEL	Quiet electric latch retraction

### Mechanical Options

GBK	Glass bead kit
LBR	Less bottom rod
SNB	Sex bolts
SEC	Security screws
WH	Weep holes

### Dogging Feature

Hex key dogging standard

### Dogging Options

CD	Cylinder dogging
LD	Less dogging
QEL	QEL options available

### Strikes

338	Top—Unfinished
385A	Bottom—Unfinished

## Accessories



338 Top strike



Top latch



385A Bottom strike



Bottom latch



Hex key dogging  
Comes standard on  
78 panic exit device



# 7847-F Fire-Rated Concealed Vertical Rod Device

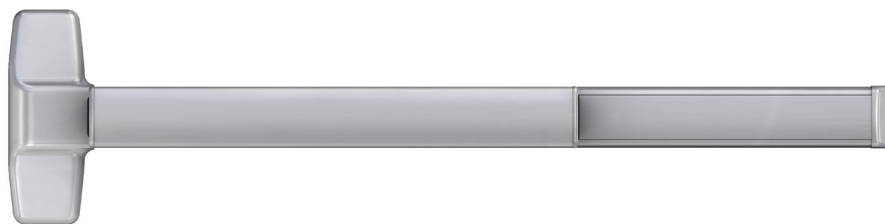

7847-F Fire exit concealed vertical rod device are certified to ANSI/BHMA A156.3 2014, Grade 1 and UL listed for fire exit hardware. [See UL fire exit hardware](#) label and door opening size information within this catalog.

Specifications	Details
Device functions	Device ships EO/DT/NL; Field selectable; For L remove NL drive screw from device
Device lengths	3' 2' 6" to 3' (762mm to 914mm) door size 4' 3' to 4' (914mm to 1219mm) door size
Device centerline from finished floor	39-13/16" (1011mm) 39-11/16" (1008mm) with mullion
Center case	7-7/8" x 2-3/4" x 2-3/8" (200mm x 70mm x 60mm)
Mechanism case	2-5/16" x 2-1/8" (59mm x 54mm)
Projection	Pushbar neutral - 3-13/16" (97 mm) Pushbar depressed - 3-1/16" (78mm)
Latch bolt	Deadlocking, 5/8" (15.875mm) throw
Finishes	US26D (626), US28 (628), 313 (710), US4 (606), US3 (605), US15 (619), US26 (625), 315 (711), 643E
Pushbar length	3' 18" (457mm) 4' 24" (610mm)
Fasteners and sex bolts (SNB)	Includes screw pack for 1-3/4" (4mm) and 2-1/4" (57mm) thick metal or wood doors (Optional 425 SNB available)

## Features & Options

Electrified Options	
LX	Latch bolt monitor switch
RX	Request to exit
E	Electric locking and unlocking trim
ALK	Alarm exit kit
CON	Allegion Connect
QEL	Quiet electric latch retraction

Mechanical Options	
GBK	Glass bead kit
LBR	Less bottom rod
SNB	Sex bolts
SEC	Security screws
WH	Weep holes

Dogging Options	
	No mechanical dogging

Strikes	
338	Top—Unfinished
385A	Bottom—Unfinished

## Accessories



338 Top strike



Top latch



385A Bottom strike



Bottom latch

## Device Types

# 7847WDC Wood Door Concealed Vertical Rod Device



7847WDC Concealed vertical rod device for use on single or double wood doors, UL listed for panic exit hardware. Devices are certified to ANSI/BHMA A156.3 2014, Grade 1.

Specifications	Details
Device functions	Device ships EO/DT/NL; Field selectable; For L remove NL drive screw from device
Device lengths	3' 2' 6" to 3' (762mm to 914mm) door size 4' 3' to 4' (914mm to 1219mm) door size
Device centerline from finished floor	39-13/16" (1011mm) 39-11/16" (1008mm) with mullion
Center case	7-7/8" x 2-3/4" x 2-3/8" (200mm x 70mm x 60mm)
Mechanism case	2-5/16" x 2-1/8" (59mm x 54mm)
Projection	Pushbar neutral - 3-13/16" (97mm) Pushbar depressed - 3-1/16" (78mm)
Latch bolt	Deadlocking top bolt, 5/8" (16mm) throw
Door undercut	1/4" (7mm) maximum
Top and bottom latch case	3 3/4" x 1 1/2" x 1" (95mm x 38mm x 25mm)
Vertical rods	Round 2-piece adjustable rods – Top rod adjustable from 6'8" (2027mm) to 8'4" (2533mm). Bottom rod adjustable 35-5/8" (905mm) to 49-5/8" (1260 mm). Extension rod kits available for doors over 8'4" (2533mm).
Scalp plate	Device is furnished standard with an 8" (203mm) long scalp plate for easy access to rods
Finishes	US26D (626), US28 (628), 313 (710), US4 (606), US3 (605), US15 (619), US26 (625), 315 (711), 643E
Fasteners and sex bolts (SNB)	Includes screw pack for 1-3/4" (4mm) and 2-1/4" (57mm) thick wood doors. (425 SNB required on wood doors without SLM blocking)

## Features & Options

### Electrified Options

LX	Latch bolt monitor switch
RX	Request to exit
E	Electric locking and unlocking trim; no cylinder override
ALK	Quiet electric latch retraction
CON	Allegion Connect
QEL	Quiet electric latch retraction

### Mechanical Options

GBK	Glass bead kit
LBR	Less bottom rod
SNB	Sex bolts
SEC	Security screws
WH	Weep holes

### Dogging Feature

Hex key dogging standard

### Dogging Options

CD	Cylinder dogging
LD	Less dogging
DI	Dogging indicator
CI	Cylinder dogging indicator

### Strikes

338	Top—Unfinished
385A	Bottom—Unfinished

## Accessories



338 Top strike



385A Bottom strike



Top latch



Bottom latch



Hex key dogging

Comes standard on 78 panic exit device

## Device Types

# 7847WDC-F Wood Door Concealed Vertical Rod Fire Device



7847WDC-F Fire exit concealed vertical rod devices are certified to ANSI/ BHMA A156.3 2014, Grade 1 and UL listed for fire exit hardware. [See UL fire exit hardware](#) label and door opening size information within this catalog.

Specifications	Details
Device functions	Device ships EO/DT/NL; Field selectable; For L remove NL drive screw from device
Device lengths	3' 2' 6" to 3' (762mm to 914mm) door size 4' 3' to 4' (914mm to 1219mm) door size
Device centerline from finished floor	39-13/16" (1011mm)
Center case	7-7/8" x 2-3/4" x 2-3/8" (200mm x 70mm x 60mm)
Mechanism case	2-5/16" x 2-1/8" (59mm x 54mm)
Projection	Pushbar neutral - 3-13/16" (97mm) Pushbar depressed - 3-1/16" (78mm)
Latch bolt	Deadlocking top and bottom bolt, 5/8" (16mm) throw
Door undercut	1/4" (7mm) maximum
Top and bottom latch case	3-3/4" x 1-1/2" x 1" (95mm x 38mm x 25mm)
Vertical rods	Round 2-piece adjustable rods – Top rod adjustable from 6'8" (2027mm) to 8'4" (2533mm). Bottom rod adjustable 35-5/8" (905 mm) to 49-5/8" (1260 mm). Extension rod kits available for doors over 8'4" (2533mm).
Scalp plate	Device is furnished standard with an 8" (203mm) long scalp plate for easy access to rods
Finishes	US26D (626), US28 (628), 313 (710), US4 (606), US3 (605), US15 (619), US26 (625), 315 (711), 643E
Fasteners and sex bolts (SNB)	Includes screw pack for 1-3/4" (4mm) and 2-1/4" (57mm) thick metal or wood doors (425 SNB required on wood doors without SLM blocking)

## Accessories



338 Top strike



385A Bottom strike



Top latch



Bottom latch

## Features & Options

### Electrified Options

LX	Latch bolt monitor switch
RX	Request to exit
E	Electric locking and unlocking trim
ALK	Alarm exit kit
CON	Allegion Connect
QEL	Quiet electric latch retraction
WP-RX	Waterproof request to exit

### Mechanical Options

GBK	Glass bead kit
LBR	Less bottom rod
SNB	Sex bolts
SEC	Security screws
WH	Weep holes

### Dogging Options

	No mechanical dogging
--	-----------------------

### Strikes

338	Top—Unfinished
385A	Bottom—Unfinished



## Device Types

# 75 Rim Exit Device

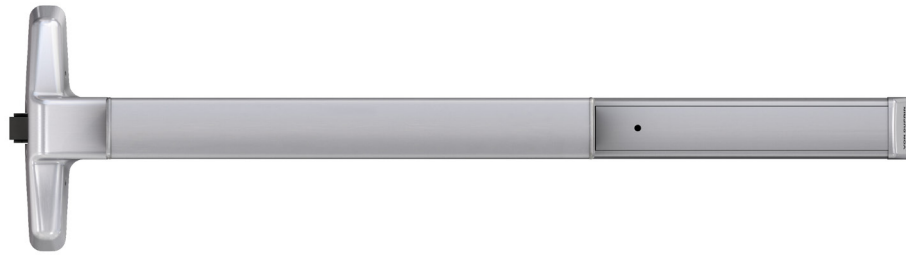

75 rim exit devices for all types of single and double doors with mullion, UL listed for panic exit hardware. Devices are certified to ANSI/BHMA A156.3 2014, Grade 1.

Specifications	Details
Device functions	Device ships EO/DT/NL; Field selectable
Device lengths	3' 2' 6" to 3' (762mm to 914mm) door size 4' 3' to 4' (914mm to 1219mm) door size
Device centerline from finished floor	39-13/16" (1011mm) 39-11/16" (1008mm) with mullion
Center case	9" x 1-5/8" x 2-3/8" (229mm x 41mm x 60mm)
Mechanism case	2-5/16" x 2-1/8" (59mm x 54mm)
Projection	Pushbar neutral - 3-13/16" (97mm) Pushbar depressed - 3-1/16" (78mm)
Latch bolt	Deadlocking, 5/8" (15.875mm) throw
Finishes	US26D (626), US28 (628), 313 (710), US4 (606), US3 (605), US15 (619), US26 (625), 315 (711), 643E, US10B (613)
Pushbar length	3' 18" (457mm) 4' 24" (610mm)
Fasteners and sex bolts (SNB)	Includes screw pack for 1-3/4" (4mm) and 2-1/4" (57mm) thick metal or wood doors (Optional 425 SNB available)

## Features & Options

### Electrified Options

LX	Latch bolt monitor switch
RX	Request to exit
E	Electric locking and unlocking trim; no cylinder override
ALK	Alarm exit kit
CON	Allegion Connect
QEL	Quiet electric latch retraction

### Mechanical Options

AX	Accessible device
GBK	Glass bead kit
SNB	Sex bolts
SEC	Security screws
WH	Weep holes

### Dogging Feature

Hex key dogging standard

### Dogging Options

CD	Cylinder dogging
LD	Less dogging
QEL	QEL options available

### Strikes

1439 Dull black

Optional strikes

## Accessories



**299 Strike**  
Needs to be specified for hollow metal frames



**1439 Roller**  
Ships standard, optional strikes available



**Hex key dogging**  
Comes standard on 75 panic exit device

## Device Types

# 75-F Fire-Rated Rim Exit Device



75-F Rim fire exit devices are certified to ANSI/BHMA A156.3 2014, Grade 1 and UL listed for fire exit hardware. [See UL fire exit hardware](#) label and door opening size information within this catalog.

Specifications	Details
Device functions	Device ships EO/DT/NL; Field selectable
Device lengths	3' 2' 6" to 3' (762mm to 914mm) door size 4' 3' to 4' (914mm to 1219mm) door size
Device centerline from finished floor	39-13/16" (1011mm) 39-11/16" (1008mm) with mullion
Center case	9" x 1-5/8" x 2-3/8" (229mm x 41mm x 60mm)
Mechanism case	2-5/16" x 2-1/8" (59mm x 54mm)
Projection	Pushbar neutral - 3-13/16" (97mm) Pushbar depressed - 3-1/16" (78mm)
Latch bolt	Deadlocking, 5/8" (15.875mm) throw
Finishes	US26D (626), US28 (628), 313 (710), US4 (606), US3 (605), US15 (619), US26 (625), 315 (711), 643E, US10B (613)
Pushbar length	3' 18" (457mm) 4' 24" (610mm)
Fasteners and sex bolts (SNB)	Includes screw pack for 1-3/4" (4mm) and 2-1/4" (57mm) thick metal or wood doors (Optional 425 SNB available)

## Features & Options

### Electrified Options

LX	Latch bolt monitor switch
RX	Request to exit
E	Electric locking and unlocking trim; no cylinder override
ALK	Alarm exit kit
CON	Allegion Connect
QEL	Quiet electric latch retraction

### Mechanical Options

AX	Accessible device
GBK	Glass bead kit
SNB	Sex bolts
SEC	Security screws
WH	Weep holes

### Dogging options

	No Mechanical dogging
--	-----------------------

### Strikes

299F	Dull black
499F	With mullion

## Accessories



**299F Strike**  
Ships standard



**499F Strike**  
With 9954 mullion

## Device Types

# 7527 Surface Mounted Vertical Rod Device

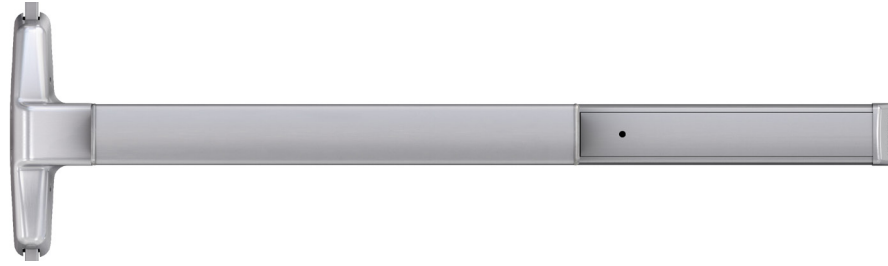

7527 Surface mounted vertical rod device for all types of single or double doors, UL listed for panic exit hardware. Devices are certified to ANSI/ BHMA A156.3 2014, Grade 1. Vertical rod and latch guards are available to protect the bottom rod of the exit device from damage by impacts of carts or gurneys passing through doors.

Specifications	Details
Device functions	Device ships EO/DT/NL; Field selectable
Device lengths	3' 2' 6" to 3' (762mm to 914mm) door size 4' 3' to 4' (914mm to 1219mm) door size
Device centerline from finished floor	39-13/16" (1011mm) 39-11/16" (1008mm) with mullion
Center case	9" x 1-5/8" x 2-3/8" (229mm x 41mm x 60mm)
Mechanism case	2-5/16" x 2-1/8" (59mm x 54mm)
Projection	Pushbar neutral - 3-13/16" (97mm) Pushbar depressed - 3-1/16" (78mm)
Latch bolt	Deadlocking, 5/8" (15.875mm) throw
Finishes	US26D (626), US28 (628), 313 (710), US4 (606), US3 (605), US15 (619), US26 (625), 315 (711), 643E, US10B (613)
Pushbar length	3' 18" (457mm) 4' 24" (610mm)
Fasteners and sex bolts (SNB)	Includes screw pack for 1-3/4" (4mm) and 2-1/4" (57mm) thick metal or wood doors (Optional 425 SNB available)

## Accessories



**266**  
Top strike,  
ships standard



**Top latch**



**Hex key dogging**  
Comes standard on  
75 panic exit device



**248L4**  
Bottom strike  
For use with  
flat threshold



**Bottom latch**



**304L Bottom strike**

## Features & Options

### Electrified Options

LX	Latch bolt monitor switch
RX	Request to exit
E	Electric locking and unlocking trim; no cylinder override
ALK	Quiet electric latch retraction
CON	Allegion Connect
QEL	Quiet electric latch retraction

### Mechanical Options

GBK	Glass bead kit
LBR	Less bottom rod
SNB	Sex bolts
SEC	Security screws
WH	Weep holes

### Dogging Feature

Hex key dogging standard

### Dogging Options

CD	Cylinder dogging
LD	Less dogging
QEL	QEL options available

### Strikes

266	Top—Dull black
248L4 & 304L	Bottom—Unfinished
	Optional strikes

# 7527-F Fire-Rated Surface Mounted Vertical Rod Device



7527-F Fire exit surface mounted vertical rod device are certified to ANSI/BHMA A156.3 2014, Grade 1 and UL listed for fire exit hardware. [See UL fire exit hardware](#) label and door opening size information within this catalog. Vertical rod and latch guards are available to protect the bottom rod of the exit device from damage by impacts of carts or gurneys passing through doors. Rod and latch guards can be used on hollow metal or tin clad composite fire doors.

Specifications	Details
Device functions	Device ships EO/DT/NL; Field selectable
Device lengths	3' 2' 6" to 3' (762mm to 914mm) door size 4' 3' to 4' (914mm to 1219mm) door size
Device centerline from finished floor	39-13/16" (1011mm) 39-11/16" (1008mm) with mullion
Center case	9" x 1-5/8" x 2-3/8" (229mm x 41mm x 60mm)
Mechanism case	2-5/16" x 2-1/8" (59mm x 54mm)
Projection	Pushbar neutral - 3-13/16" (97mm) Pushbar depressed - 3-1/16" (78mm)
Latch bolt	Deadlocking, 5/8" (15.875mm) throw
Finishes	US26D (626), US28 (628), 313 (710), US4 (606), US3 (605), US15 (619), US26 (625), 315 (711), 643E, US10B (613)
Pushbar length	3' 18" (457mm) 4' 24" (610mm)
Fasteners and sex bolts (SNB)	Includes screw pack for 1-3/4" (4mm) and 2-1/4" (57mm) thick metal or wood doors (Optional 425 SNB available)

## Features & Options

Electrified Options	
LX	Latch bolt monitor switch
RX	Request to exit
E	Electric locking and unlocking trim; no cylinder override
ALK	Alarm exit kit
CON	Allegion Connect
QEL	Quiet electric latch retraction

Mechanical Options	
GBK	Glass bead kit
SNB	Sex bolts
SEC	Security screws
WH	Weep holes

Dogging Options	
	No mechanical dogging

Strikes	
299F/ (499F for LBR)	Top—Dull black
248L4 & 304L	Bottom—Unfinished
	Optional strikes

## Accessories

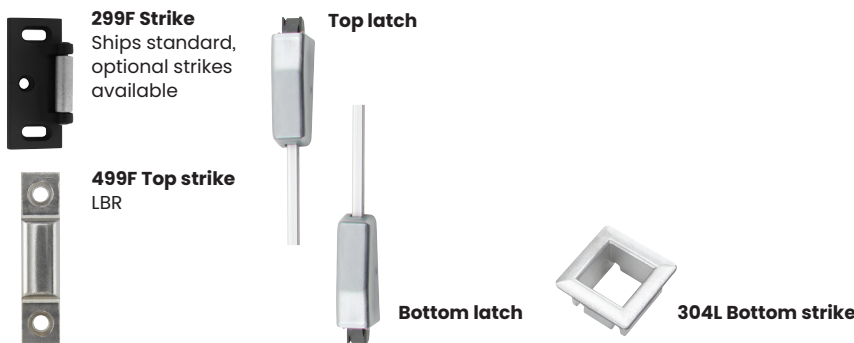



## Device Types

# 7547 Concealed Vertical Rod Device

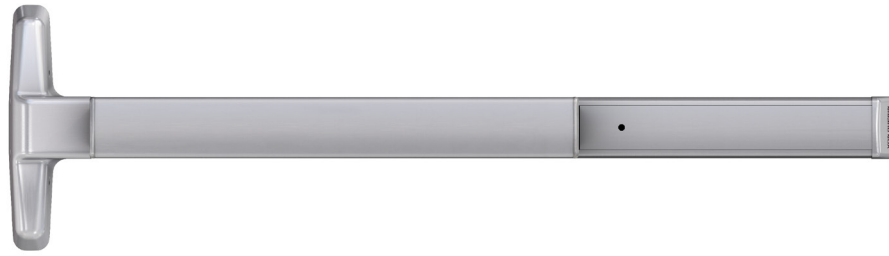

7547 Concealed vertical rod device for use on single or double metal doors, UL listed for panic exit hardware. These are certified to ANSI/BHMA A156.3 2014, Grade 1.

Specifications	Details
Device functions	Device ships EO/DT/NL; Field selectable
Device lengths	3' 2' 6" to 3' (762mm to 914mm) door size 4' 3' to 4' (914mm to 1219mm) door size
Device centerline from finished floor	39-13/16" (1011mm) 39-11/16" (1008mm) with mullion
Center case	9" x 1-5/8" x 2-3/8" (229mm x 41mm x 60mm)
Mechanism case	2-5/16" x 2-1/8" (59mm x 54mm)
Projection	Pushbar neutral - 3-13/16" (97mm) Pushbar depressed - 3-1/16" (78mm)
Latch bolt	Deadlocking, 5/8" (15.875mm) throw
Finishes	US26D (626), US28 (628), 313 (710), US4 (606), US3 (605), US15 (619), US26 (625), 315 (711), 643E, US10B (613)
Pushbar length	3' 18" (457mm) 4' 24" (610mm)
Fasteners and sex bolts (SNB)	Includes screw pack for 1-3/4" (4mm) and 2-1/4" (57mm) thick metal or wood doors (Optional 425 SNB available)

## Features & Options

### Electrified Options

LX	Latch bolt monitor switch
RX	Request to exit
E	Electric locking and unlocking trim; no cylinder override
ALK	Quiet electric latch retraction
CON	Allegion Connect
QEL	Quiet electric latch retraction

### Mechanical Options

GBK	Glass bead kit
LBR	Less bottom rod
SNB	Sex bolts
SEC	Security screws
WH	Weep holes

### Dogging Feature

Hex key dogging standard

### Dogging Options

CD	Cylinder dogging
LD	Less dogging
QEL	QEL options available

### Strikes

388	Top—Unfinished
385A	Bottom—Unfinished
	Optional strike

## Accessories



388 Top strike



Top latch



385A Bottom strike



Bottom latch



Hex key dogging  
Comes standard on  
75 panic exit device

# 7547-F Fire-Rated Concealed Vertical Rod Device



7547-F Fire exit concealed vertical rod device are certified to ANSI/BHMA A156.3 2014, Grade 1 and UL listed for fire exit hardware. [See UL fire exit hardware](#) label and door opening size information within this catalog.

Specifications	Details
Device functions	Device ships EO/DT/NL; Field selectable
Device lengths	3' 2' 6" to 3' (762mm to 914mm) door size 4' 3' to 4' (914mm to 1219mm) door size
Device centerline from finished floor	39-13/16" (1011mm) 39-11/16" (1008mm) with mullion
Center case	9" x 1-5/8" x 2-3/8" (229mm x 41mm x 60mm)
Mechanism case	2-5/16" x 2-1/8" (59mm x 54mm)
Projection	Pushbar neutral - 3-13/16" (97mm) Pushbar depressed - 3-1/16" (78mm)
Latch bolt	Deadlocking, 5/8" (15.875mm) throw
Finishes	US26D (626), US28 (628), 313 (710), US4 (606), US3 (605), US15 (619), US26 (625), 315 (711), 643E, US10B (613)
Pushbar length	3' 18" (457mm) 4' 24" (610mm)
Fasteners and sex bolts (SNB)	Includes screw pack for 1-3/4" (4mm) and 2-1/4" (57mm) thick metal or wood doors (Optional 425 SNB available)

## Features & Options

Electrified Options	
LX	Latch bolt monitor switch
RX	Request to exit
E	Electric locking and unlocking trim; no cylinder override
ALK	Alarm exit kit
CON	Allegion Connect
QEL	Quiet electric latch retraction

Mechanical Options	
GBK	Glass bead kit
LBR	Less bottom rod
SNB	Sex bolts
SEC	Security screws
WH	Weep holes

Dogging Options	
	No mechanical dogging

Strikes	
388	Top—Unfinished
385A	Bottom—Unfinished
	Optional strike

## Accessories



388 Top strike



Top latch



385A Bottom strike



Bottom latch

## Trim options

# Trim Functions

Von Duprin protects your investment by empowering you to adapt with flexible solutions and modular options. The 78 and 75 Series features numerous trim options to serve your different needs. Designed with flexibility in mind, our solutions offer ease of adding new options as they are developed.

With Von Duprin, you can be confident that as the needs of your facility change, our products can be upgraded easily to meet your needs, especially as the mechanical and electronic technology converge. Von Duprin's versatile design enables you to add functionality to existing devices in a cost-effective way, protecting your investment well into the future.

A variety of device trim lock type functions such as key lock and unlock, latch bolt retraction with key and no cylinder designs for an "always operable" function are available in levers, knobs, latches, thumbpiece and thumbturn designs.

## Trim options

# 78 Series Trim Functions

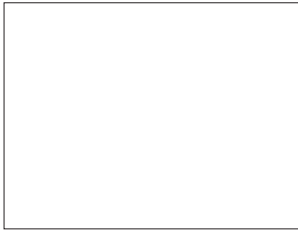

EO  
No outside

- Exit only

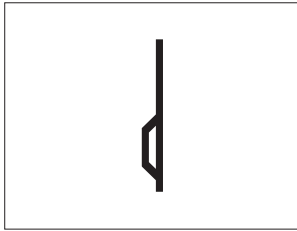

DT  
Dummy

- Pull when dogged (not recommended for fire device)

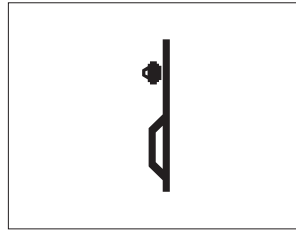

NL  
Night latch

- Key retracts latch bolt
- Rim cylinder

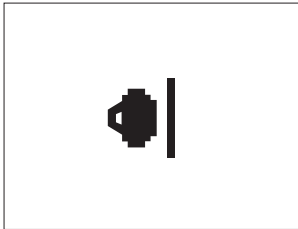

NLOP  
Night latch

- Key retracts latch bolt, pull required
- Rim cylinder

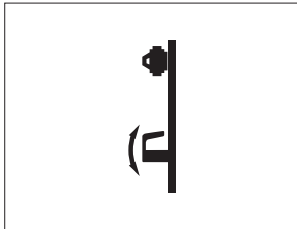

L  
Lever

- Key locks and unlocks
- 1-1/4" mortise cylinder
- Handed, reversible lever
- Electrified lever operation available

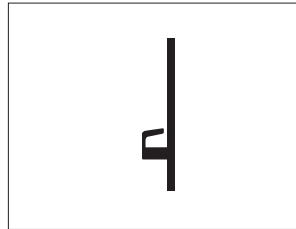

LDT  
Lever, dummy trim

- Pull when dogged

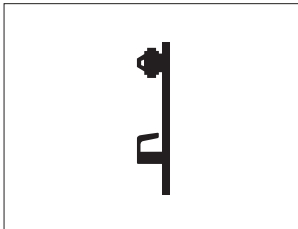

LNL  
Lever, night latch

- Key retracts latch bolt
- 1-1/4" mortise cylinder
- Handed, reversible lever

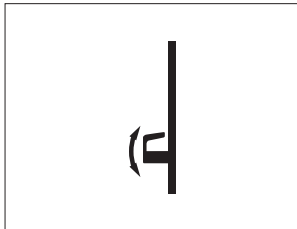

LBE<sup>1</sup>  
Lever, blank escutcheon

- Always operable (no cylinder)

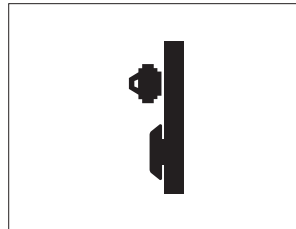

TL  
Turn lever

- Key locks and unlocks; or key unlocks, then relocks when key is removed (use with DT trim)
- 1-1/4" mortise cylinder

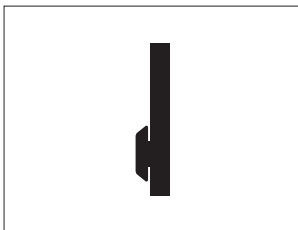

TLBE  
Turn lever, blank escutcheon

- Blank escutcheon always operable (no cylinder, use with DT trim)



## Trim options

# 75 Series Trim Functions

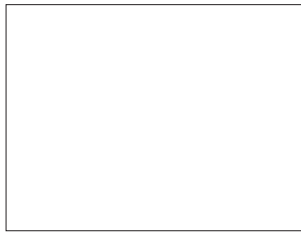

EO  
No outside

- Exit only

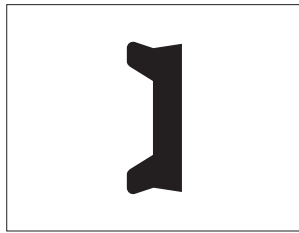

DT  
Dummy

- Pull when dogged (not recommended for fire device)

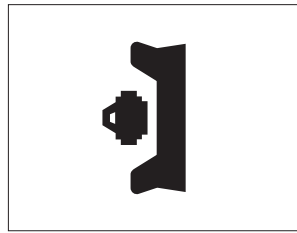

NL  
Night latch

- Key retracts
- Rim cylinder

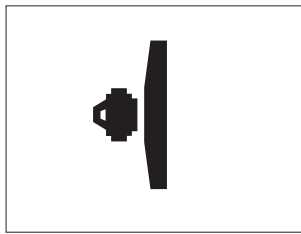

NLOP  
Night latch

- Key retracts latch bolt, optional pull required
- Rim cylinder

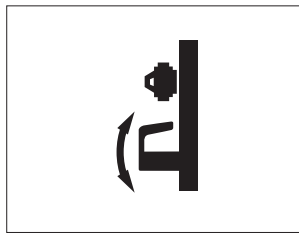

L  
Lever

- Key locks and unlocks; or key unlocks, then relocks when key is removed.
- 1-1/4" mortise cylinder
- Handed, reversible lever

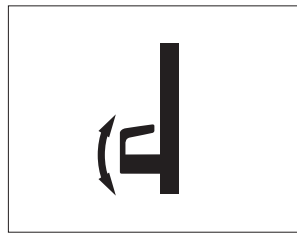

LBE  
Lever, blank escutcheon

- Always operable (no cylinder)
- Electrified lever operation available

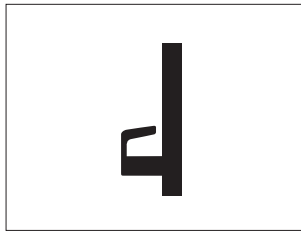

LDT  
Lever, dummy trim

- Pull when dogged

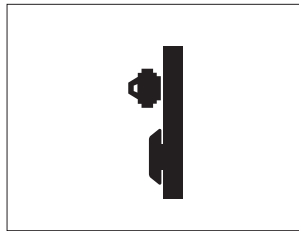

TL  
Turn lever

- Key locks and unlocks; or key unlocks, then relocks when key is removed (use with DT trim)
- 1-1/4" mortise cylinder

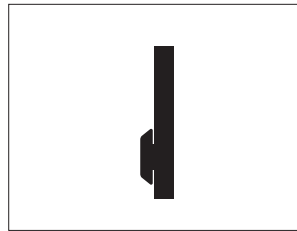

TLBE  
Turn lever, blank escutcheon

- Blank escutcheon always operable (no cylinder, use with DT trim)

# No Trim

None



Trim Description		
Nomenclature	EO	110NL-MD 110NL-WD
Trim function	Exit only	Dummy trim
Function description	No outside trim	Night latch Key retracts latch bolt Optional pull required
ANSI function	01	03
Device Compatibility		
78 Rim	•	•
78 Rim-F	•	•
7827	•	•
7827-F	•	•
7847	•	•
7847-F	•	•
75 Rim	•	
75 Rim-F	•	
7527	•	
7527-F	•	
7547	•	
7547-F	•	
Dimensions		
Escutcheon plate size	-	-
Pull center to center	-	-
Projection	-	-
<b>Cylinder Type</b>	-	Rim
<b>Handing</b>	-	-

## Trim options

## 780 Trim



Trim Description				
Nomenclature	780L	780L-NL	780L-BE	780L-DT
Trim function	-	-	-	-
Function description	Lever Key locks and unlocks	Lever-night latch Key retracts latch bolt	Lever-blank escutcheon Always operable, no cylinder	Lever-dummy trim Pull when dogged
ANSI function	08	03	14	02
Device Compatibility				
78 Rim	•	•	•	•
78 Rim-F	•	•	•	•
7827	•	•	•	•
7827-F	•	•	•	•
7847	•	•	•	•
7847-F	•	•	•	•
75 Rim				
75 Rim-F				
7527				
7527-F				
7547				
7547-F				
Dimensions				
Escutcheon plate size	9-3/4" x 2-3/4" x 7/8" (248 x 70 x 22mm)			
Pull center to center	-	-	-	-
Projection	3-1/4" (83mm)	3-1/4" (83mm)	3-1/4" (83mm)	3-1/4" (83mm)
Cylinder Type	Mortise	Mortise	-	-
Handing	Handed/reversible	Handed/reversible	Handed/reversible	Handed/reversible



# 785 Trim



Trim Description			
Nomenclature	785EO	785DT	785NL
Trim function			
Function description	Exit only plate	Dummy trim Pull when dogged	Night latch Key retracts latch bolt Optional pull required
ANSI function	01	02	03
Device Compatibility			
78 Rim	•	•	•
78 Rim-F	•	•	•
7827	•	•	•
7827-F	•	•	•
7847	•	•	•
7847-F	•	•	•
75 Rim			
75 Rim-F			
7527			
7527-F			
7547			
7547-F			
Dimensions			
Escutcheon plate size	3" x 14-3/16" x 3/32" (76 x 360 x 2mm)		
Pull center to center	5-1/2" (140mm)	5-1/2" (140mm)	5-1/2" (140mm)
Projection	2" (51mm)	2" (51mm)	2" (51mm)
<b>Cylinder Type</b>	-	-	Rim
<b>Handing</b>	-	-	-

## Trim options

## 785 Control x 374 &amp; 785 Control x 376 Trim



Trim Description				
Nomenclature	785DT x 374T	785DT x 374T-BE	785DT x 376T	785DT x 376T-BE
Trim function				
Function description	Thumbturn Key locks and unlocks; or key unlocks, then relocks when key is removed	Thumbturn-blank escutcheon always operable (no cylinder)	Thumbturn Key locks and unlocks; or key unlocks, then relocks when key is removed	Thumbturn-blank escutcheon always operable (no cylinder)
ANSI function	11-12 field selectable*		11-12 field selectable*	
<b>Device Compatibility</b>				
78 Rim				
78 Rim-F				
7827	•	•		
7827-F	•	•		
7847			•	•
7847-F			•	•
75 Rim				
75 Rim-F				
7527				
7527-F				
7547				
7547-F				
<b>Dimensions</b>				
Escutcheon plate size	TL: 1-11/16" x 7-1/2" x 7/8" (43 x 191 x 22mm) DT: 3" x 14-3/16" x 3/32" (76 x 360 x 2mm)			
Pull center to center	-	-	-	-
Projection	2" (51mm)	2" (51mm)	2" (51mm)	2" (51mm)
<b>Cylinder Type</b>	1-1/4" mortise	-	1-1/4" mortise	-
<b>Handing</b>	-	-	-	-

\*Field-selectable by inverting or un-inverting cam.

## Trim options

## 386 &amp; 388 Trim



Trim Description			
Nomenclature	386DT	386NL	388
Trim function	Dummy trim		
Function description	Pull when dogged	Night latch Key retracts latch bolt	Night latch Key retracts latch bolt optional pull required
ANSI function	02	03	03
<b>Device Compatibility</b>			
78 Rim			
78 Rim-F			
7827			
7827-F			
7847			
7847-F			
75 Rim	•	•	•
75 Rim-F	•	•	•
7527	•	•	•
7527-F	•	•	•
7547	•	•	•
7547-F	•	•	•
<b>Dimensions</b>			
Base width	1-5/8"	1-5/8"	1-11/16"
Base height	7-15/32"	7-15/32"	7-15/32"
Projection	2-7/16"	2-7/16"	1"
Grip width	4-5/16"	4-5/16"	-
Grip height	8-1/2"	8-1/2"	-
<b>Cylinder Type</b>	-	Rim	Rim
<b>Handing</b>	-	Handed	-



## Trim options

## 360 Trim



<b>Trim Description</b>			
Nomenclature	360L	360L-BE	360L-DT
Trim function			
Function description	Lever Key locks and unlocks	Lever blank escutcheon always operable (no cylinder)	Lever Pull when dogged
ANSI function	08 or 09 field selectable*	-	02
<b>Device Compatibility</b>			
78 Rim			
78 Rim-F			
7827			
7827-F			
7847			
7847-F			
75 Rim	•	•	•
75 Rim-F	•	•	
7527	•	•	•
7527-F	•	•	
7547	•	•	•
7547-F	•	•	
<b>Dimensions</b>			
Base width	1-11/16"	1-11/16"	1-11/16"
Base height	7-1/2"	7-1/2"	7-1/2"
Projection	3"	3"	3"
Grip width	-	-	-
Grip height	-	-	-
<b>Cylinder Type</b>	1-1/4" mortise	-	-
<b>Handing</b>	Handed/Reversible	Handed/Reversible	Handed/Reversible

\*Field-selectable by inverting or un-inverting cam.

## Trim options

## 386 Dummy Trim x 374 Control or 376 Control



Trim Description				
Nomenclature	386DT x 374T	386DT x 374T-BE	386DT x 376T	386DT x 376T-BE
Trim function				
Function description	Key locks and unlocks; or key unlocks, then relocks when key is removed	Thumbturn-blank escutcheon always operable (no cylinder)	Key locks and unlocks; or key unlocks, then relocks when key is removed	Thumbturn-blank escutcheon always operable (no cylinder)
ANSI function	11-12 field selectable*		11-12 field selectable*	
<b>Device Compatibility</b>				
78 Rim				
78 Rim-F				
7827				
7827-F				
7847				
7847-F				
75 Rim				
75 Rim-F				
7527	•	•		
7527-F	•	•		
7547			•	•
7547-F			•	•
<b>Dimensions</b>				
Escutcheon plate size	TL: 1-11/16" x 7-1/2" x 7/8" (43 x 191 x 22mm)			
Pull center to center	-	-	-	-
Projection	-	-	-	-
<b>Cylinder Type</b>	1-1/4" mortise	-	1-1/4" mortise	-
<b>Handing</b>	-	-	-	-

\*Field-selectable by inverting or un-inverting cam.

Mechanical options

# Dogging Options

## Cylinder Dogging (CD)



Cylinder dogging is available on all 78 and 75 panic exit devices to replace the standard hex key dogging. Unit requires a standard 1-1/4" (32mm) mortise cylinder with an inverted straight cam. When ordering, reference Schlage cylinder 20-001, 1-1/4", XQ11-949. This provides the L583-477 cam inverted at the factory.

**To order, specify:**

- Use prefix, CD, example CD78L

## Less Dogging (LD)

Less dogging is available in all 78 and 75 Panic exit devices to remove the dogging option.

**To order, specify:** Use prefix LD, example LD78L

## Cylinder Dogging Kit\* (CDK)

For field conversion, from hex key dogging, conversion kit is available.

\*Cannot be added to fire exit hardware.

**To order, specify:**

- 78CDK or 75CDK, specify finish

## Hex Key Dogging Kit\* (HDK)



For field conversion, from cylinder dogging, conversion kit is available.

\*Cannot be added to fire exit hardware.

**To order, specify:**

- 78HDK or 75HDK, specify finish

## Dog Key

Dog key (standard)

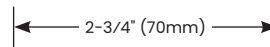

5/32" (4mm) hex

## Weatherized Options

### Weep Holes (WH)

WH is available for all 78 and 75 Series exit devices. Weep holes are ideal for devices that are mounted to exterior doors that can be exposed to rain and other elements. Hole spacing on 3' and 4' devices are every 6" on center. A 3-foot device will have 5 holes, a 4-foot device will have 7 holes.

**To order, specify:**

- Suffix WH, 78EO-WH
- Specify handing



## Mechanical options

# Accessibility Options

### Accessible Device (AX)

The AX device is a UL certified exit device designed to meet the progressive requirements of the California Building Code for accessible openings. This device meets the 5 lbs of operating force requirement called for in chapter 11B-309.4. The AX device also exceeds ANSI/BHMA requirements.

Available devices include: AX-78-R, AX-78-R-F, AX-7827-LBR, AX-7827-F-LBR, AX-75-R, AX-75-R-F. Additionally, all AX devices will be shipped with a UL label clearly stating “Meets California Building Code (2013) Sec. 11B-309.4” and an “AX” identifier label on device center case. See images for reference.



## Latches

### Less Bottom Rod, Panic and Fire Rated (LBR)

LBR option is available on panic rated devices by eliminating the bottom rod, latch, and strike. LBR option is available on fire rated devices, using a spring loaded auxiliary latch bolt installed in the lower door edge. When exposed to heat the auxiliary latch bolt releases, keeping the doors in alignment and closed during a fire. See UL fire exit hardware label and door opening size information within this catalog. Fits door stiles as narrow as 3-5/8".

Fire-rated LBR devices must be ordered in pairs or must be used in conjunction with an approved automatic or constant latching flush bolt.

# Mechanical options

This page intentionally left blank.

## Electrified options

# Latch Retraction

## Quiet Electric Latch Retraction (QEL)

Quiet electric latch retraction (QEL) provides electronic control of an exit device for environments where limited operational noise is desired. These devices always provide mechanical egress. The electrified latch retraction can also be activated by an access system or building automation system to unlatch the exit device momentarily. Often the QEL is used with a credential reader and access control system to unlock the door momentarily for authorized users.

The QEL can also be configured to electronically retract the latch for an extended period of time to allow free entry. This is a convenient alternative to mechanical dogging. If manual dogging is required, the hex dogging option is available, to order specify HD-QEL.

The QEL option is available on panic devices and fire rated devices. UL approved for Class II circuit applications.

The QEL option does not include the power transfer from door to frame, the power supply, or the control operator. Refer to EPT-2 power transfer and the PS902 or 914 power supply.

The 900 Series power supply with the 2RS, 4RL or 4R board is the minimum required. Other option boards available for other functions, see 900 Series power supply for additional information.

The QEL has a low in rush current, so it can be used with standard Schlage power supplies. Calculate the peak current draw of all devices in the system to determine the required amperage of the supply.

The -2RS option board is designed to control two electric latch retraction devices and provide time delay between the firing of outputs is required. The power transfer is also sold separately.

### To order, specify:

- Standard — Use prefix QEL, example QEL78L

**Note:** Baseplate and modular QEL conversion kits are available for field retrofit. Please see parts/service manual for part numbers.

Schlage PS902	Schlage PS904	Schlage PS906
Up to 2 amps	Up to 4 amps	Up to 6 amps

QEL Electrical Load	
Voltage	24VDC
Current	1.0 A Inrush (0.5 sec.)/0.14 A Holding

Minimum Door Opening Widths*			
Application	Surface Vertical	Concealed Vertical	Rim
Minimum door opening	29-1/2"	29-1/2"	30-1/2"

\*For 3' devices. For 4' devices, add 6".

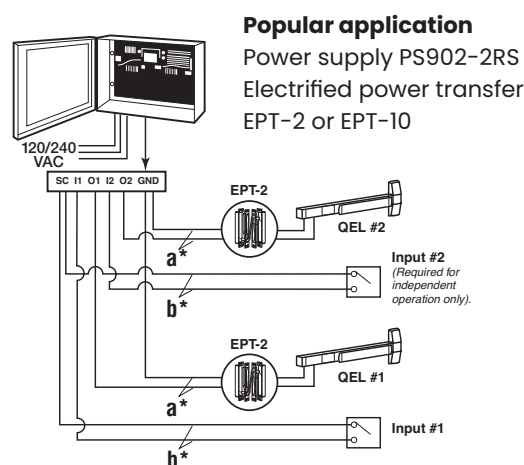

a*	Distance (One-Way)	Wire Gauge
	200'	18 AWG
	320'	16 AWG
	500'	14 AWG
	800'	12 AWG

b*	Wire Selection	Switch Wire Size
	1200 ft. max	18 gauge standard



## Electrified options

# Switches

### Request to Exit (RX)

The RX feature is used to signal the use of an opening. This device is equipped with one internal SPDT switch which monitors the push pad.

The device can be connected to a security console, or may be used as a single door alarm when used with a horn and power supply.

The RX switch option should not be used to control a load, but as a signaling switch (2 amps resistive maximum).

**To order, specify:**

- Standard – Use prefix RX, example RX78EO

### Latch Bolt Monitoring (LX)

The LX feature is used to signal the use of an opening. This device is equipped with one internal SPDT switch which monitors the latch bolt.

The device can be connected to a security console, or may be used as a single door alarm when used with a horn and power supply.

The LX switch option should not be used to control a load, but as a signaling switch (2 amps resistive maximum).

**To order, specify:**

- Standard – Use prefix LX, example LX78EO

**Note:** All switches can be either factory or field installed

## Electrified options

# Alarm Kit



Alarm kit (ALK) is a simple yet effective way to deter unauthorized use of an opening. While the exit device is still a means of egress, the ALK kit contains an internal horn. When the touch bar is depressed, the horn sounds to provide an audible means of signaling that the opening has been violated. The alarm kit can be armed or disarmed by key thus allowing the exit device to be set in an armed or disarmed mode. The horn is rated at 85 decibels.

For hardware applications, the assembly includes both a 24VDC Input and External Inhibit standard. The External Inhibit provides remote arming and dis-arming.

The key switch uses a standard 1-1/4" (32mm) mortise cylinder with a straight cam (Schlage 20-001, L583-477 cam). The unit operates on one standard 9-volt alkaline battery. When the battery is weak, the horn will emit an intermittent low battery alert signal.

Auto reset (AR) option is available with this kit. This kit allows the device to resume the alarm option after a preset time. Preset times can be field selected at 1.5, 3, or 4.5 minutes.

Alarm kits are available with a choice of two switch kits, RX or LX. RX monitors the touchpad and is furnished standard. LX optional latch bolt monitoring is recommended for use with surface vertical rod exit devices or when alarm needs to sound from both the exit device and trim side of the door. Specify ALK-LX.

**Note:** For latch bolt monitoring on a 78 and 7575 with ALK, specify a SS7500 lock. LX switch not available for 78 and 7575 devices.

The ALK includes a 6" x 20" decal for application on door "EMERGENCY EXIT ONLY. ALARM WILL SOUND." RSS push bar trim can be used instead of the door decal, specify RSS push bar trim when ordering the device.

When the ALK is used, standard dogging is removed. If cylinder dogging is required, there are two choices. Special center case dogging (SD) is available. Or, as an engineered special, the ALK can be moved to the hinge side of the device, and standard cylinder dogging (CD) can be added. Note size restrictions below.

### To order, specify:

- Standard, 78 ALK

### Minimum door opening sizes on ALK applications

Device	3' (914mm) Length	4' (1219mm) Length
78/78-F/75/75-F	2' 11-1/2" (902mm)	3' 5-1/2" (1054mm)
7827/7827-F/7527/7527-F	2' 11-1/2" (902mm)	3' 5-1/2" (1054mm)
7847/7847-F/7547/7547-F	2' 10-1/2" (876mm)	3' 4-1/2" (1029mm)

## Electrified options

# Electrified Trim

### Applies to 78 Exit Device Only

#### E780L/L-BE Electrified Lever Trim

E780L/L-BE Electrified lever trim provides remote locking and unlocking. Available in either fail safe (FS) or fail secure (FSE) condition.



FS (Fail safe—unlocks when power is interrupted) can be used in areas requiring doors to be unlocked due to fire, power failure or emergency situations. (Examples: stairwells, fire exits, etc.)

FSE (Fail secure—locks when power is interrupted can be used in areas requiring doors to be locked for security reasons and only unlocked when energized by authorized personnel. (Examples: banks, inner-office, etc.)

With either feature, authorized personnel can gain access utilizing key by overriding or bypassing electric locking function.

#### Specifications

- Solenoid rated for continuous duty at 24V DC 0.4 amps
- UL listed devices
- Device channel is used as conduit on 78 Series devices
- Power transfer (EPT-2) hinge 2-wire minimum rated 1/2 amp

#### Minimum Power Supply—PS902

The series 902 power supply is the recommended power supply for use with an FSA or FSE trim. The series 902 power supply is also designed for electric locking or monitoring of single or double door applications.

#### RX Option

RX option available for 780 trim to monitor lever trim operation (available as L or L-BE). To order, add RX prefix to trim description.

**Note:** The RX switch option should not be used to control a load, but as a signaling switch only.

#### To order, specify:

- Use "E" prefix, example E780L or E780L-LBE. When ordering with the exit device, specify trim series with prefix "E", example 7827L x 626 x E780
- RHR furnished standard if not specified
- Lever style (06 lever furnished standard)  
Other levers, no extra charge
- Other lever designs available, see pages 54 and 55

### Applies to 75 Exit Device Only

#### E360 Electric Trim

Specify Fail Safe (FS) or Fail Secure (FSE). 24VDC furnished standard, 12VDC available through special order.



#### To order, specify:

- Prefix lever or thumbturn control with "E"  
Example: E360L-BE, E360T-BE
- E360LBE, E360TBE functions
- 01, 02, 03, 05, 07, 12, 16, 17, Latitude (LAT)

# Power Supplies

## PS900 Series Power Supplies



The PS900 Series is a consolidated line of power supplies and accessories that offer enhanced flexibility and functionality specific to the changing needs of the access control market. The PS900 Series can be used in a variety of applications to convert high voltage AC power into the regulated low voltage DC outputs required by most access control devices. The PS900 Series protects devices downstream by providing Class 2, filtered and regulated power. The full line is UL294 certified.

### Features

- Constant output rating at both 12VDC or 24VDC provides superior performance; includes field selectable jumper
- Flat mounting of option boards provides easier access to terminal blocks for connection of electrified devices
- High voltage protective cover
- Battery back-up board auto-selects voltage
- Fire alarm relay can be configured to provide either switched or un-switched outputs from a power supply
- PS914 designed with high inrush current for powering electrified panic devices
- Universal 120–240 VAC input
- Low voltage DC, regulated and filtered
- Electronic power limiting foldback circuit for AC current overload protection
- Fused primary input
- AC status monitor—isolated SPDT contacts
- AC input and DC output LED status indicators
- Cover mounted AC input indication
- Hinged cover with lock down screws
- Optional keylock

### Certifications

- UL 294 certified—the standard for access control
- Class 2 rated



## Electrified options

# Power Supplies

## PS900 Series Power Supplies

The PS900 Series offers a variety of distribution options, including basic fuse protection, simple relay, and advanced logic providing complex sequencing and timing functions.

Connectors on the Power Supply				
Product	Schlage PS902	Schlage PS904	Schlage PS904	Von Duprin PS914
Amperage	2 amps	4 amps	6 amps	4 amps with 16 amp inrush
Distribution boards	1	2	3	2
Battery back-up board	1	1	1	1
EL Compatible	No	No	No	Yes

## Applications

The PS900 Series of power supplies works with many electrified devices including Schlage electromagnetic locks, Schlage AD Series hardwired locks, Schlage electrified mechanical locks, Von Duprin electrified strikes, Von Duprin exit devices and many other brands.

## Accessories

The PS900 Series features seven option boards for use in a variety of applications. All PS900 Series power supplies option boards are UL 294 certified.

## Option Boards

- **900-4R:** 4 relay controlled output board to power multiple devices
  - **900-4RL:** 4 relay distribution board with logic is field configurable for time delay function, auto operator, security interlock
  - **900-8F:** Provides 8 individually fuse-protected outputs, giving the flexibility to power multiple devices and provide another layer of protection
  - **900-8P:** Provides 8 individually fuse-protected outputs, giving the flexibility to power multiple devices and provide another layer of protection
  - **900-FA:** Emergency interface relay integrates with fire alarm and is used to cut power in case of emergency<sup>2</sup>
  - **900-BB:** Battery backup
  - **900-2RS:** 2 relay control board for electric latch panic devices (EL or QEL), electric strikes or electrified trim
  - **900-BBK:** Battery backup kit includes two 7A/hr batteries and provides up to four hours of backup power when cycled every 5 minutes at full load
1. PS906 can provide Class 2 rated outputs when used with 900-8P distribution board.
  2. Except PS906, output rating exceeds Class 2 power limits.
  3. PS906, output rating exceeds Class 2 power limits, but can provide Class 2 rated outputs when used with 900-8P distribution board.

## Electrified options

# Electrical Power Transfers

## Electrical Power Transfer (EPT)

Electrical Power Transfer provides a means of transferring electrical power from a door frame to the edge of a swinging door. The units are completely concealed when the door is in the closed position, and are ideal for installations involving abuse or heavy traffic.

Two models are available; EPT-2, two 18 gauge wires and EPT-10, ten 24 gauge wires. The EPT-2 and EPT-10 are U/L listed as "miscellaneous door accessory". UL Listed for use on fire doors.

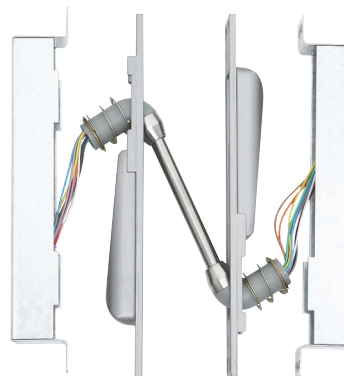

Door Applications		
Degree of Opening	Hinge Type	Door Thickness
0-180	Up to 5" butt hinges	1-3/4"
0-180	Up to 3/4" offset pivots	1-3/4"
0-130	5-1/2" butt hinges	1-3/4"
0-110	6" butt hinges	1-3/4"
0-90	Swing clear hinges	1-3/4"

## Finishes

- SP28 (sprayed aluminum)
- SP313 (sprayed duranodic)
- 622

Dimensions	
Housing	9" x 1-1/4" x 1-5/8" (229mm x 32mm x 38mm)
EPT-2	Two 18 gauge wires, up to 2 amps @ 24VDC, with a 16 amps Maximum Surge
EPT-10	Ten 24 gauge wires, up to 1 amp @ 24VDC, with a 16 amps Maximum Surge

### To order, specify:

- EPT-2 or EPT-10
- Finish: SP28, SP313 or 622

## Electrified options

# Allegion Connect

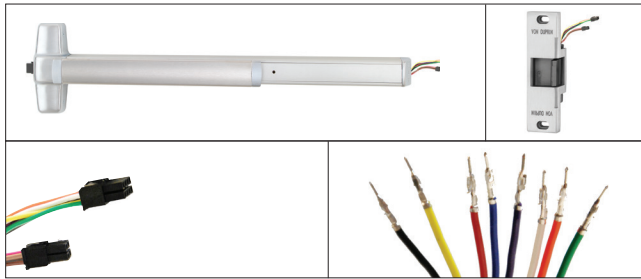

Allegion Connect features common interconnect components for many cross-category electrified options. Allegion Connect is a quick and easy way to connect power sources. There is no wire cutting; reducing installation and maintenance time ultimately cutting cost. After installation, Allegion Connect continues to provide benefits throughout the lifetime of the opening by offering a service kit for repairs or modifications in the future.

### Features & Benefits

- **Quick:** Common connections reducing installation time
- **Perfect Connections:** These factory installed connectors ensure the right wires match up every time
- **Protective:** The connectors protect the connection points throughout the installation process and lifetime of the opening
- **Interchangeable:** All Allegion Connect products utilize the same connectors
- **Maintenance:** You no longer need to cut away wire to disconnect Allegion products, also available is a service kit specifically for Allegion Connect products.

### Wire Run Options

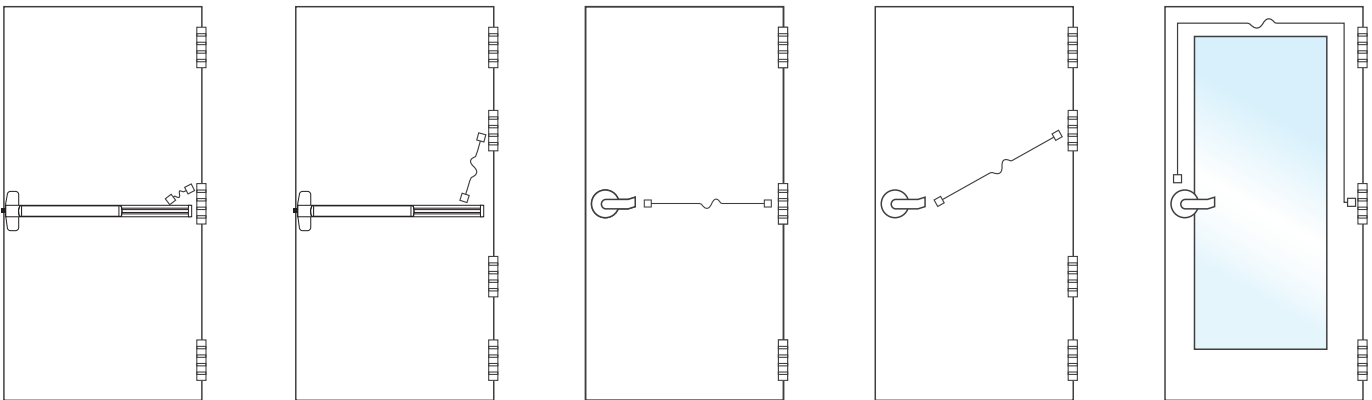

Harness Length	Connectors on Both Ends	Connectors on One End, Crimped Pins on the Other End
6 inches	CON-6	CON-6P
12 inches	CON-12	CON-12P
26 inches	CON-26	CON-26P
32 inches	CON-32	CON-32P
38 inches	CON-38	CON-38P
44 inches	CON-44	CON-44P
50 inches	CON-50	CON-50P
192 inches	CON-192	CON-192P

Power supply wire harness = connectors on one end, stripped leads on the other end.

6 inches	CON-6W—wire extension to power supply
----------	---------------------------------------

Consult door manufacturer for harness length requirements.

**Note:** You will need to purchase a separate wiring harness to go from exit device to hinge/EPT, and a CON-6W harness to connect the hinge/EPT to field wiring in the walls. Harness part numbers with ordering information can be located in the Schlage, Von Duprin and Falcon price books. A service kit is available for order in the Schlage, Von Duprin and Falcon price books. Included in this kit are male end plugs, female end plugs and pins to customize harnesses to your application.

**Note:** Must be ordered with exit devices and locks

#### To order, specify:

- Specify CON for Connect electronic options  
Example: QEL-78-EO-CON  
(78 Series quiet electric latch retraction exit only with Connect connectors)
- Specify harness length; Consult door manufacturer for harness length
- Specify Von Duprin EPT10-CON or Ives electrical thru-wire hinge

# Strikes

## FOR RIM DEVICES

**264**

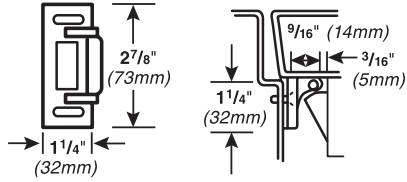

Projection 9/16" (14mm)

**299**

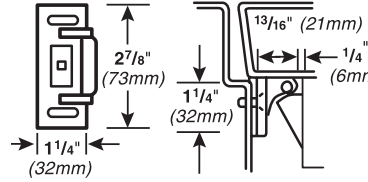

Projection 13/16" (21mm)

**299F**

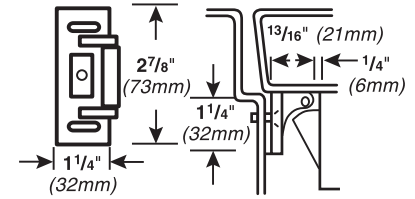

Projection 13/16" (21mm)

**499F**

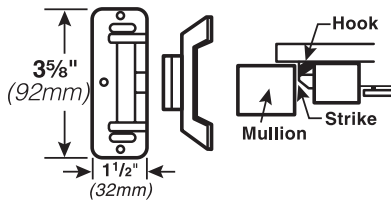

Projection 15/16" (24mm)

**1408**

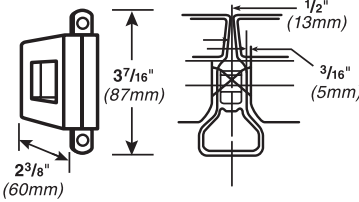

One per pair of doors

**1439-Blade stop**

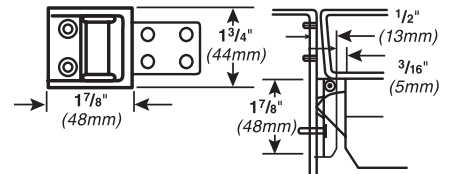

Projection 1/2" (13mm)

**1410-Integral stop**

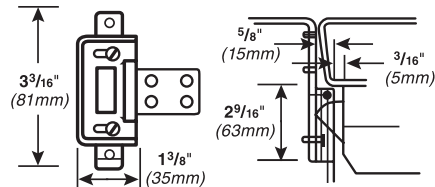

Projection 1/2" (13mm)

**1606**

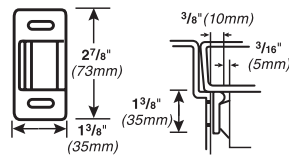

Projection 3/8" (10mm)  
(Panic devices only)

**1609**

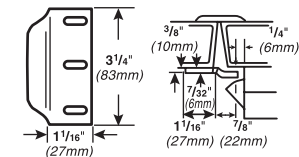

Requires coordinator  
For panic exit application only, not fire rated

## Strikes

## FOR VERTICAL ROD DEVICES

## 248L-4

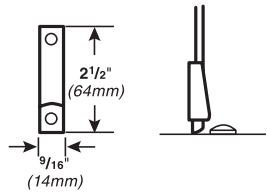

Projection 3/8" (10mm)

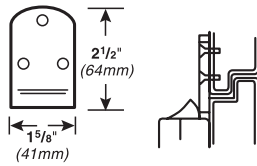
260U Flush transom panic only  
260U-F Flush transom fire only

Projection 3/8" (10mm)

## 299

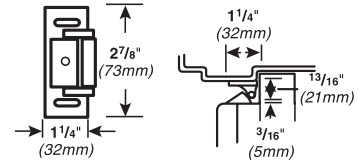

Projection 13/16" (21mm)

## 299F

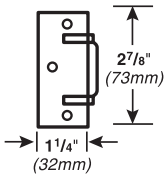

Projection 13/16" (21mm)

## 499F

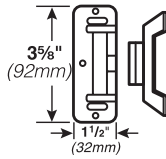

Projection 15/16" (24mm)

## 304L

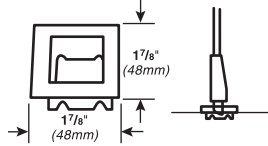

Projection 13/16" (21mm)

## 338

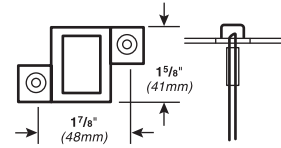

Mortise 5/8" (16mm)

## 385A

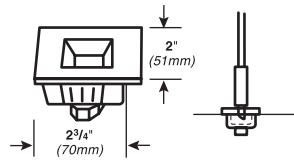

Mortise 2-1/2" (64mm)

## 283

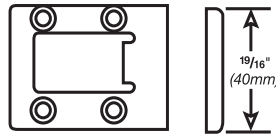
For use with WDC devices  
when used with wood frames

## Cylinders

Cylinders are not furnished with device or trim and must be specified when ordering. Refer to trim pages for cylinder type.



## Mortise — 3215

(Schlage 20-001, L583-477 cam)

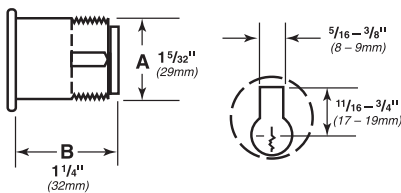

## Dogged (inverted) cam

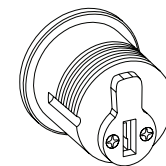

For CD

Undogged cam  
(standard operations)For ALK and all 78 and 75 Series  
mortise cylinder trims and controls

## Rim — 3216

(Schlage 20-022)

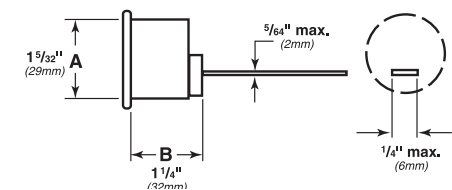



## Accessories

# Door Kits

## Vertical Rod and Latch Guard (RG-27)

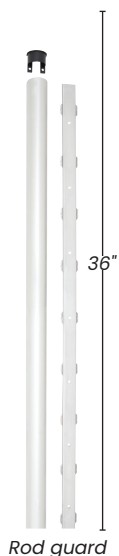

Rod guard

Series RG-27 Vertical rod and latch guards protect the bottom rods of exit devices from the damaging impacts of carts or gurneys passing through doors. (If bottom rods become damaged, the exit device will not function as intended and can jeopardize the ability to exit safely during an emergency.)

In addition to protecting the vertical rod, the guard provides a smooth, unobstructed surface so the door can be pushed open easily with the bumpers of a wheelchair. The latch guard portion is 10" high. The standard latch guard features a 45° ramp. The extended latch guard offers a continuous ramp for 3' or 4' doors.

All stainless steel construction in 630 finish. Latch guards can cover latches as large as 1-1/4" W x 10" H x 1-7/8" projection.

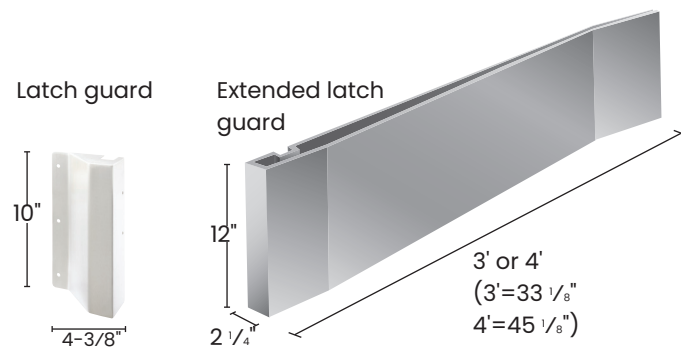

Models	
RGO	Rod guard only (projection 1-3/16")
RG-27	Rod and latch guard
RG-27-3	3' (914mm) Rod guard and extended latch guard
RG-27-4	4' (1219mm) Rod guard and extended latch guard
LGO	Latch guard only
LGO-3	3' (914mm) Extended latch guard only
LGO-4	4' (1219mm) Extended latch guard only

When using on wood fire doors, high density block is required.

\* RGO/RG-27 includes one rod guard only, which accommodates bottom or top rod up to 7" door. For longer top rods, specify rod guard quantity required.

### To order, specify:

- Model number\*
- Handing (except on RGO)
- Door material if other than hollow metal
- Optional sex bolt mounting available

## Glass Bead Kit (GBK)

Glass bead conversion kits are available for all 78 and 75 Series devices for use on doors with raised glass beads. Each kit consists of 1/4" (6mm) shim sets. GBK for surface vertical rod ships with 1/8" shims for rod guides.

### To order, specify:

- Device model
- GBK
- Device type (rim, surface rod, concealed rod)
- Specify if using with 499F
- Finish

**Example:** 78 GBK Rim SP28

## Accessories

# Sex Bolts

Sex bolts provide secure mounting by mating with machine screws furnished with devices. Sex bolts are either optional or required, as shown in quantity chart below. Sex bolts ordered separately are not furnished with screws. If screws are required, order device mounting packages.

### To order sex bolts:

If ordering devices with sex bolts, specify SNB (sex nuts and bolts) in device description.

If ordering sex bolts separately, specify:

- Sex bolt model number
- Package quantity (sold as package of 2)
- Finish

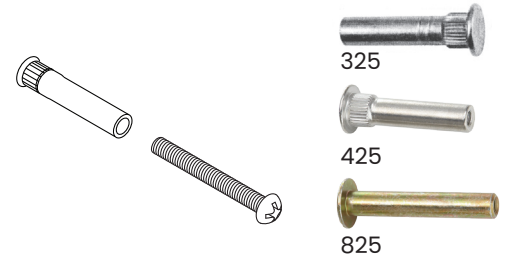

## Accessories

# Mullions

### Removable Steel Mullions

Removable steel mullions provide single door performance in double door openings with rim devices.

Mullions are easily removed by loosening bottom set screw and removing top fitting cover. The top mullion fitting is attached to the frame and is concealed by the fitting cover.

- Steel mullions are 2" (51mm) wide and 3" (76mm) deep, with a wall thickness of 1/8" (3mm)
- Mullions are shipped with mounting screws and prepared for strikes (strikes are not included except where indicated)
- Steel mullions are available in SP28 and SP313 finishes (Consult factory for other powder coat finish options)

### Keyed Removable Steel Mullions (KR)

KR mullions make removal faster and easier by a single operation of the mortise cylinder. Once mullion is removed, large equipment or furniture can freely pass through the opening. The unit will self lock when re-installed, without the use of the cylinder key. Uses a 1-1/4" mortise cylinder with a straight cam (Schlage cam reference L583-477). Cylinders are sold separately. Prefix mullion model with "KR".

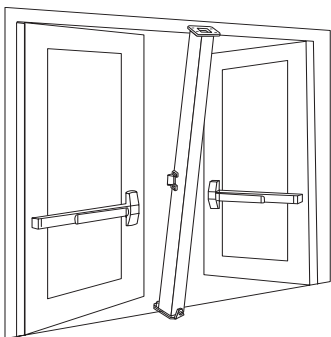

Removable mullions

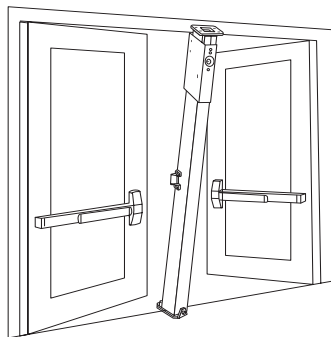

Keyed removable steel mullions

### Aluminum Mullions

Removable aluminum mullions are 1 1/16" (27mm) wide on face closest to the door and 2-3/8" (60mm) at the widest point. The depth is 3-1/8" (79mm) with a wall thickness of 1/8" (3mm).

Aluminum mullions are available in 606, 612, 628, 710 and 622/711 finishes. Consult factory for other powder coat finish options. Aluminum mullions are not available keyed removable.

Stock hollow metal applications for devices mounted to cover ANSI 161 cutouts are higher than the standard mullion strike location. Consult the factory for special strike preparation or order a blank mullion. See below.

### Blank Mullions

are furnished without strike preparation. They are used to mount devices at a strike height different from the standard mullion preparation.

#### To order, specify:

- For keyed removable option on steel mullions, prefix model number with "KR"
- Model number
- Height of opening
- Finish
- Handing, if required
- Centerline deviation (refer to device template for standard centerline)
- Strikes, when required, should be ordered with device

## Accessories

## Steel and Aluminum Mullions

## Steel Mullions

4954	Prepared for two 299 strikes (standard). With KR option.
9954	Prepared for and must be used with two 499F strikes. UL fire labeled mullion for up to 3 hour opening using Von Duprin fire exit rim devices. With KR option.
4854	Prepared for one 299 and one 6111 electric strike. Indicate handing for electric strike. With KR54-F kit option.
9854	Prepared for one 268 or 499F strike and one 6111 electric strike. Indicate handing for electric strike. UL fire labeled mullion for up to 3 hour openings up to 8' x 8' (2438mm x 2438mm) using Von Duprin fire exit rim devices. With KR option.

## Aluminum Mullions

5654	Prepared for two 299 strikes (standard only), no KR option.
5754	Prepared for 1408 double strike

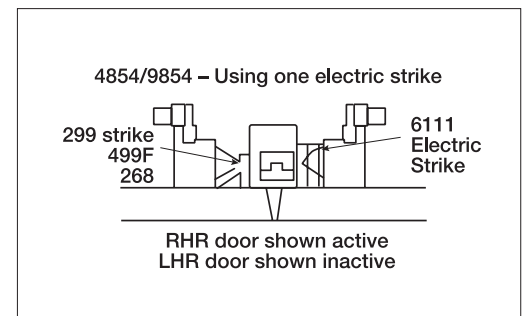
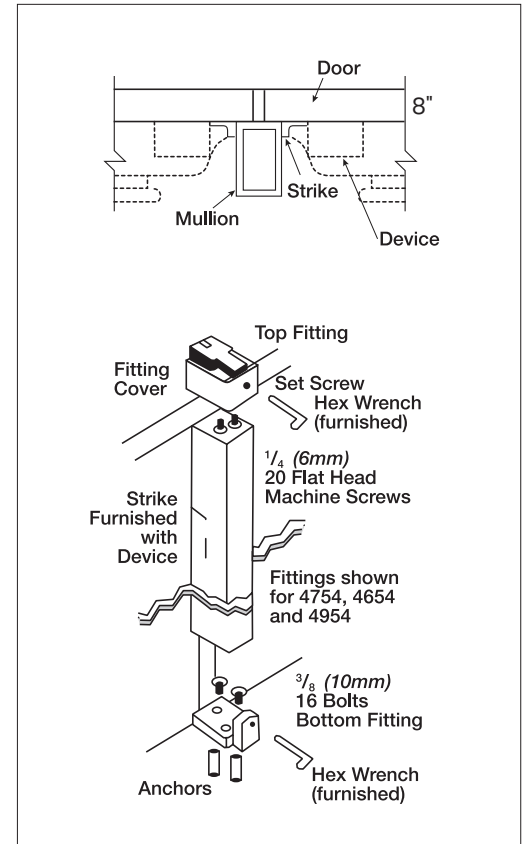

# UL Listing for 78 Series Fire Exit Hardware



UL Listed Fire Exit Hardware Label and Opening Size									
Exit Device	Door Material	Single Door	Double Door						
			With 9954 mullion	With 9854 mullion <sup>4</sup>	With KR9954 mullion	With KR9854 mullion <sup>4</sup>	V x V same direction <sup>1</sup>	V x mortise same direction <sup>3</sup>	V x V double egress
<b>78-F</b>	Metal, composite (wood or plastic covered)	3 Hour 4' x 10'	3 Hour 8' x 10'	90 Min 8' x 8'	3 Hour 8' x 8'	90 Min 8' x 8'	—	—	—
<b>78-F with 1439 Strike</b>	Metal, composite (wood or plastic covered)	3 Hour 4' x 8'	—	—	—	—	—	—	—
<b>7827-F</b>	Metal, composite (wood or plastic covered)	—	—	—	—	—	3 Hour 8' x 10'	3 Hour 8' x 10'	3 Hour 8' x 10'
<b>7827LBR-F</b>	Metal, composite (wood or plastic covered)	—	—	—	—	—	3 Hour 8' x 8'	3 Hour 8' x 8'	3 Hour 8' x 8'
<b>7827LBR-F<sup>2</sup></b>	Wood core	—	—	—	—	—	20 Min no hose 8' x 8'	20 Min no hose 8' x 8'	20 Min no hose 8' x 8'
<b>7847-F</b>	Metal, composite (wood or plastic covered)	—	—	—	—	—	3 Hour 8' x 10'	3 Hour 8' x 10'	3 Hour 8' x 10'
<b>7847LBR-F</b>	Metal, composite (wood or plastic covered)	—	—	—	—	—	3 Hour 8' x 9'	3 Hour 8' x 9'	3 Hour 8' x 9'
<b>7847WDC-F</b>	Composite (wood or plastic covered)	—	—	—	—	—	90 Min 8' x 9'3"		20 Min 8' x 9'3"
<b>7847WDC-LBR-F</b>	Composite (wood or plastic covered)	—	—	—	—	—	90 Min 8' x 9'3"		90 Min 8' x 9'3"
<b>7847WDC-LBR-F<sup>2</sup></b>	Wood core	—	—	—	—	—	20 Min no hose 8' x 9'3"		20 Min no hose 8' x 9'3"

1. Fire-rated metal door flush bolts may be substituted on one leaf of a pair in these columns. Substitute two-point flush bolt for vertical devices; or substitute top flush bolt with auxiliary fire bolt for vertical rod LBR/LBL-AFL devices. The opening will carry the fire listing (# hours and opening size) of the least rated component.
2. Not listed for Canada.
3. For Vertical x Mortise opening sizes, see applicable vertical rod/cable device rows.
4. Hourly limitation due to 6111 electric strike listing.

**Notes:**

Check with door manufacturers to confirm listing compatibility.  
Overlapping astragal may not be used on pairs swinging same direction with vertical rods or cables on both leaves.

# UL Listing for 75 Series Fire Exit Hardware



## UL Listed Fire Exit Hardware Label and Opening Size

Exit Device	Door Material	Single Door	Double Door					
			With 9954 mullion	With 9854 mullion <sup>2</sup>	With KR9954 mullion	With KR9854 mullion <sup>1</sup>	V x V same direction <sup>1</sup>	V x V double egress
<b>75-F</b>	Metal, composite (wood or plastic covered)	3 Hour 4' x 10'	3 Hour 8' x 10'	90 Min 8' x 8'	3 Hour 8' x 8'	90 Min 8' x 8'	—	—
<b>75-F with 1439 Strike</b>	Metal, composite (wood or plastic covered)	3 Hour 4' x 8'	3 Hour 4' x 8'	90 Min 8' x 8'	3 Hour 4' x 8'	90 Min 8' x 8'	—	—
<b>7527-F</b>	Metal, composite (wood or plastic covered)	—	—	—	—	—	3 Hour 8' x 10'	3 Hour 8' x 10'
<b>7527-LBR-F</b>	Metal, composite (wood or plastic covered)	—	—	—	—	—	3 Hour 8' x 10'	3 Hour 8' x 10'
<b>7547-F</b>	Metal, composite (wood or plastic covered)	—	—	—	—	—	3 Hour 8' x 10'	3 Hour 8' x 10'
<b>7547-F-LBR</b>	Metal, composite (wood or plastic covered)	—	—	—	—	—	3 Hour 8' x 9'	3 Hour 8' x 9'

1. Fire-rated metal door flush bolts may be substituted on one leaf of a pair in these columns. Substitute two-point flush bolt for vertical devices; or substitute top flush bolt with auxiliary fire bolt for vertical rod LBR/LBL-AFL devices. The opening will carry the fire listing (# hours and opening size) of the least rated component.
2. Hourly limitation due to 6111 electric strike listing.

### Notes:

Check with door manufacturers to confirm listing compatibility.  
Overlapping astragal may not be used on pairs swinging same direction with vertical rods or cables on both leaves.



# ANSI Function, Grade and Type

78 Function	Grade 1, Type 1	Grade 1, Type 2	Grade 1, Type 8
1	78-EO 78-EO-F	7827-EO 7827-EO-F	7847-EO 7847-EO-F
2	78-DT 78-DT-F	7827-DT 7827-DT-F	7847-DT 7847-DT-F
3	78-NL 78-NL-F	7827NL 7827NL-F	7847NL 7847NL-F
3	78L-NL-OP 78L-NL-OP-F	7827-NL-OP 7827-NL-OP-F	7847-NL-OP 7847-NL-OP-F
8	78L 78L-F	7827L 7827L-F	7847L 7847L-F
14	78L-BE 78L-BE-F	7827L-BE 7827L-BE-F	7847L-BE 7847L-BE-F
2	78L-DT	7827L-DT	7847L-DT
9	78L-NL 78-NL-F	7827L-NL 7827 L-NL-F	7847-NL 7847 L-NL-F
11/12		7827-TL 7827-TL-F	7847-TL 7847-TL-F
16		7827-TL-BE 7827-TL-BE-F	7847-TL-BE 7847-TL-BE-F

75 Function	Grade 1, Type 4	Grade 1, Type 5	Grade 1, Type 6, 7 and 8
1	75-EO 75-EO-F	7527-EO 7527-EO-F	7547-EO 7547-EO-F
2	75-DT 75-DT-F	7527-DT 7527-DT-F	7547-DT 7547-DT-F
3	75-NL 75-NL-F	7527-NL 7527-NL-F	7547-NL 7547-NL-F
3	75-NL-OP 75-NL-OP-F	7527-NL-OP 7527-NL-OP-F	7547-NL-OP 7547-NL-OP-F
8/9	75-L 75-L-F	7527-L 7527-L-F	7547-L 7547-L-F
14	75-L-BE 75-LBE-F	7527-LBE 7527-LBE-F	7547-L-BE 7547-L-BE-F
2	75-L-DT	7527-L-DT	7547-L-DT
11/12		7527-TL 7527-TL-F	7547-TL 7547-TL-F
16		7527-TL-BE 7527-TLBE-F	7547-TL-BE 7547-TL-BE-F

## Stile Information

78 and 78-F								
Device Type	Standard Single Door		Standard Double Door		Optional Single Door		Optional Double Door	
	Strike	Trim/Stile	Strike with Mullion*	Trim/Stile	Strike	Trim/Stile	Strike with Mullion*	Trim/Stile
		785/780		785/780		785/780		785/780
<b>78</b>	299	4-1/2" (114mm)	299 x 4954	4-7/8" (124mm)	1439 or 1410	3-13/16" (97mm)	299 x 5654	4-7/16" (113mm)
<b>78-F</b>	299F	4-1/2" (114mm)	499F x 9954	4-7/8" (124mm)	1606	4-1/16" (103mm)	499F x 9854 KR9954	

7827, 7827-F, 7847, 7847-F				
Device Type	Strike	Optional Strike	Application	Trim/Stile
				785/780
<b>7827</b>	299 (Top) 304L/248L-4 (Bottom)	260U (Top) 385A (Bottom)	Single door Two vertical rod devices	3-11/16" (94mm)
<b>7827-F</b>	299F* (Top) 304L (Bottom)	260U (Top) 385A (Bottom)		
<b>7847</b>	338 (Top) 385A (Bottom)	304L (Bottom)		
<b>7847-F</b>	338 (Top) 385A (Bottom)	304L (Bottom)	Two vertical rod devices	4-1/4" (108mm)

\* 499F strike is the top strike for LBR applications.

75, 7527, 7527-F, 7527-LBR-F, 7547, 7547-F, 7547-LBR, 7547-LBR-F								
Device Type	Standard Single Door		Standard Double Door		Optional Single Door		Optional Double Door	
	Strike	Trim/Stile	Strike with Mullion*	Stile	Strike	Stile	Strike with Mullion*	Stile
<b>75</b>	1439	2" (51mm)	1408 x 5754	2" (51mm)	299 1410	2-3/4" (70mm) 1-3/4" (44mm)	299 x 5654 299 x 4954	2-5/8" (67mm) 3-5/16" (84mm)
<b>7527</b>	266 (Top) 304L (Bottom) 248-L (Bottom)	2" (51mm)	266 (Top) 304L (Bottom) 248-L (Bottom)	2" (51mm)	299 (Top) 385A (Bottom) 260U (Top) 385A (Bottom)	3-1/8" (79mm) 2-1/8" (54mm)	299 (Top) 385A (Bottom) 260U (Top) 385A (Bottom)	3-1/8" (79mm) 2-1/8" (54mm)
<b>7527-F</b>	—	—	299F (Top) 304L (Bottom)	3-1/8" (79mm)	—	—	—	—
<b>7527-LBR-F</b>	—	—	499F (Top) (Req. auxiliary fire latch)	3-5/8" (92mm)	—	—	—	—
<b>7547</b>	338 (Top) 385A (Bottom)	2-1/8" (54mm)	338 (Top) 385A (Bottom)	2-1/8" (54mm)	304L (Bottom)	2-1/2" (64mm)	304L (Bottom)	2-1/2" (64mm)
<b>7547-F</b>	—	—	338 (Top) 385A (Bottom)	3-5/8" (92mm)	—	—	304L (Bottom)	3-1/2" (89mm)
<b>7547-LBR</b>	338 (Top)	2-1/2" (64mm)	338 (Top)	2-1/2" (64mm)	—	—	—	—
<b>7547-LBR-F</b>	—	—	338 (Top)	3-5/8" (92mm)	—	—	—	—

## 78 Series Dimensions

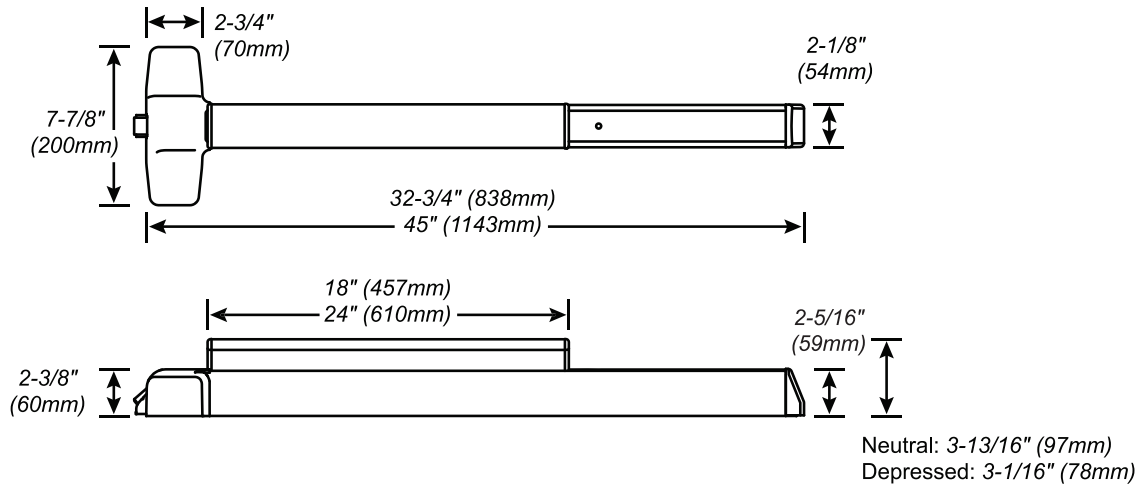



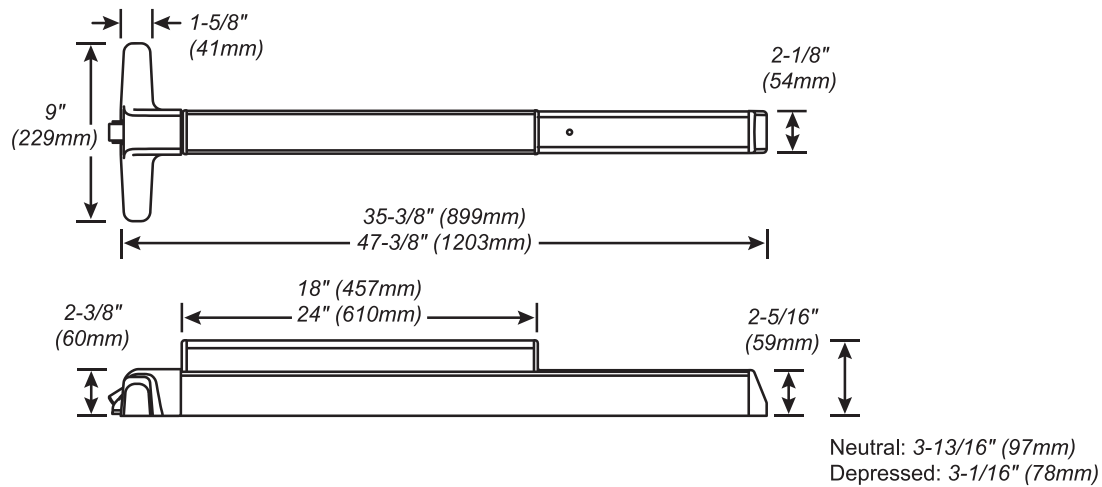











## 75 Series Dimensions





















## Additional information

## Standard Levers

<b>01</b> 	<b>02<sup>2</sup></b> 	<b>03<sup>1,2</sup></b> 	<b>05</b> 
<b>06<sup>1,2</sup> - Default lever</b> 	<b>07</b> 	<b>12<sup>3</sup></b> 	<b>16 - Omega</b> 
<b>17<sup>1,2</sup></b> 	<b>18</b> 	<b>ACC - Accent<sup>3</sup></b> 	<b>AST - Asti<sup>3</sup></b> 
<b>MER - Merano<sup>3</sup></b> 	<b>LAT - Latitude<sup>1</sup></b> 	<b>LON - Longitude<sup>1</sup></b> 	

1. Available in Stainless Steel - specify SS when ordering
2. Knurling available
3. Handed

# Decorative Levers

<p><b>M51<sup>2</sup></b></p> 	<p><b>M52<sup>2</sup></b></p> 	<p><b>M53</b></p> 	<p><b>M54</b></p> 
<p><b>M55</b></p> 	<p><b>M56</b></p> 	<p><b>M57<sup>1</sup></b></p> 	<p><b>M61<sup>3</sup></b></p> 
<p><b>M62<sup>1,3</sup></b></p> 	<p><b>M63<sup>3</sup></b></p> 	<p><b>M81<sup>2</sup></b></p> 	<p><b>M82</b></p> 
<p><b>M83</b></p> 	<p><b>M84</b></p> 	<p><b>M85<sup>3</sup></b></p> 	<p><b>ME1<sup>2,3,4</sup></b></p> 
<p><b>ME2<sup>2,3,4</sup></b></p> 	<p><b>ME3<sup>2,3</sup></b></p> 		

1. Available in stainless steel substrate ONLY
2. Knurling available
3. Handed
4. Designed with Gensler as product design consultant

## Additional information

## Device Finish Options

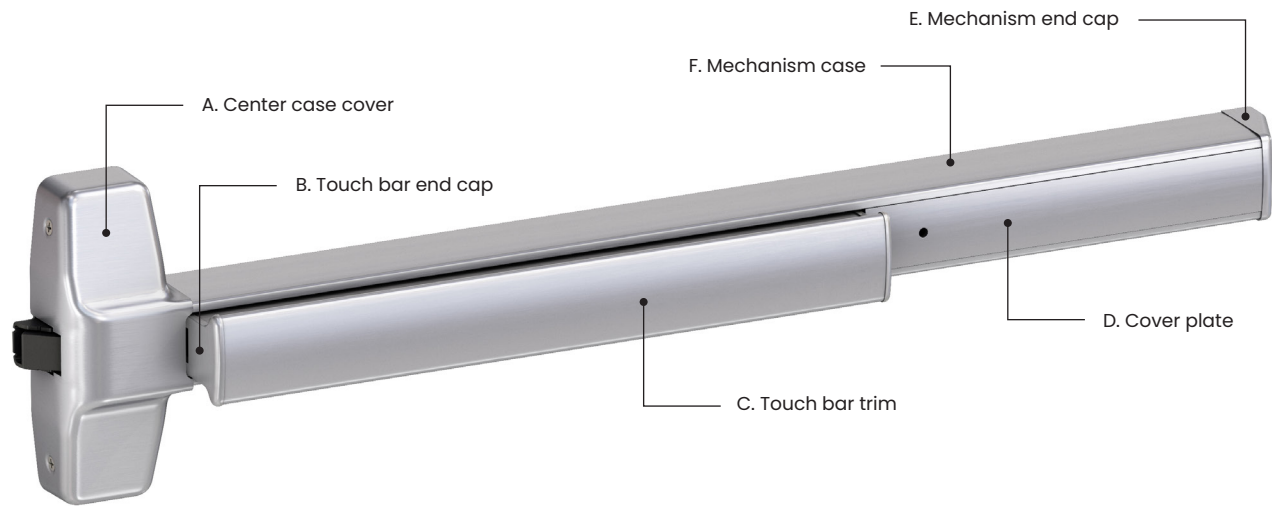

## FINISHES

605  
Bright Brass606  
Satin Brass612  
Satin Bronze619  
Satin Nickel625  
Bright Chrome626  
Satin Chrome628  
Aluminum,  
Anodized630  
Satin Stainless  
Steel643e  
Aged Bronze710  
Dark Brown,  
Anodized711  
Matte Black

Color	BHMA Number	A, B, E	C	D & F
Bright brass	605	Bright brass	Bright brass, 605	Buffed anodized
Satin brass	606	Satin brass	Satin brass, 606	Anodized
Satin bronze	612	Plated	Satin bronze, 612	Anodized
Satin nickel	619	Plated	Satin stainless steel, 630	Anodized
Bright chrome	625	Plated	Bright stainless steel, 629	Buffed anodized
Satin chrome	626	Plated	Satin stainless steel, 630	Anodized
Aluminum, anodized	628	Powder coat	Satin stainless steel, 630	Anodized
Satin stainless steel*	630	Stainless steel	Satin stainless steel, 630	Anodized
Aged bronze	643e	Relieved aged bronze	Relieved aged bronze	Aged bronze, no relief
Duranodic dark bronze	710	Powder coat	Powder coat	Powder coat
Matte black	711	Powder coat	Powder coat	Powder coat

\* Durable powder coated finishes available at special request. Please contact factory.





## About Allegion

Allegion (NYSE: ALLE) is a global pioneer in seamless access, with leading brands like CISA®, Interflex®, LCN®, Schlage®, SimonsVoss® and Von Duprin®. Focusing on security around the door and adjacent areas, Allegion secures people and assets with a range of solutions for homes, businesses, schools and institutions.

For more, visit [www.allegion.com](http://www.allegion.com)

KRYPTONITE ■ LCN ■  ■ STEELCRAFT ■ VON DUPRIN