



911327-00

Surface Vertical Latch

VON DUPRIN

Replacement Kit

Installation Instructions

1. Remove device center case cover, latch case covers, rod guides, rods, rod guide bases, latches, latch brackets, and existing sex bolts.
2. Enlarge screw holes on inside of door to 5/16" diameter. Outside holes for sex bolts should be 13/32" diameter.
3. Install new brackets and latches with #325 sex bolts and 1/4-20 screws (use 3/4" long screws for 1 3/4" door, 1 1/4" long screws for 2 1/4" door).

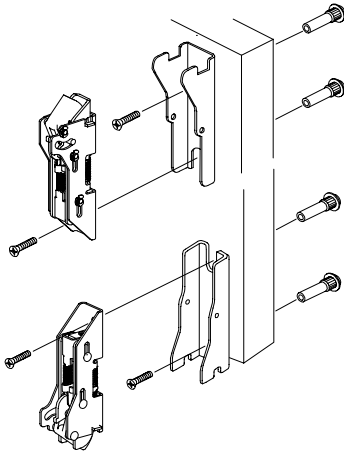

4. With device undogged and door closed, screw rods into latches.

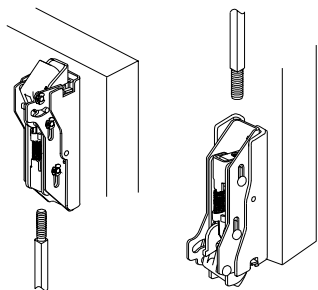

5. Push top rod to extend top latch bolt.
6. Connect top rod to center case. Screw rod into or out of latch to fit center case with latch bolt extended.

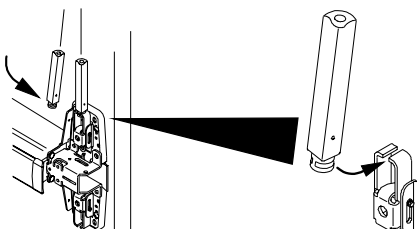

7. Test top latch deadlatching: Top latch bolt should not retract when pressed down.

Latch bolt does not retract when pressed

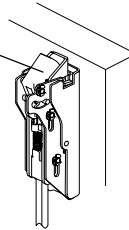

8. Lift bottom rod to retract bottom latch bolt and depress pushbar to open door. Release pushbar. Top latch bolt should stay retracted.

Latch bolt stays retracted when pushbar released

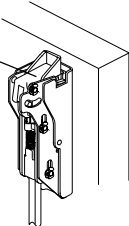

9. Lift bottom rod so bottom latch bolt retracts and clears floor and bottom strike. (Latch bolt can stick out of the latch case as long as it clears the floor and strike.)

Latch bolt clears floor and strike

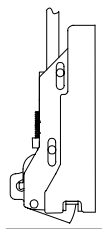

10. Connect bottom rod to center case. Screw rod into or out of latch to fit center case with latch bolt retracted.

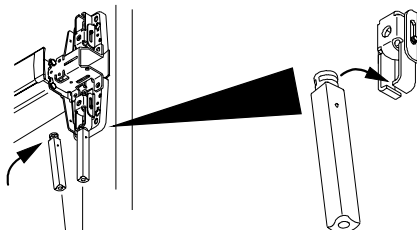

11. Check device operation by opening and closing door. Re-adjust rods if top latch bolt is not held retracted or bottom latch bolt hits floor or strike.

12. Disconnect rods from center case, slide rod guide bases on rods, and re-connect rods.

13. Install center case cover.

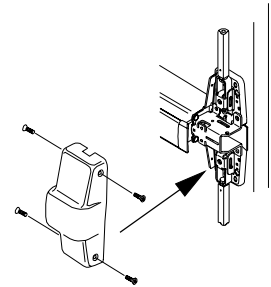

14. Install rod guides.

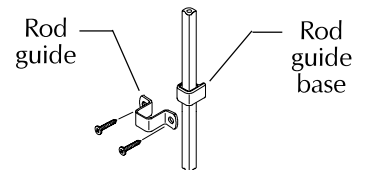

15. Install latch case covers.

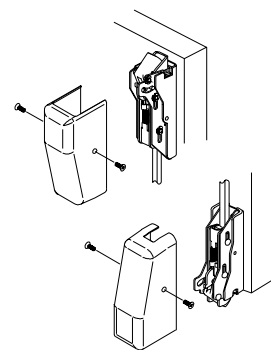

Customer Service
1-877-671-7011 www.allegion.com/us



© Allegion 2014
Printed in U.S.A.
911327-00 Rev. 01/14-b