



2720 Tobey Drive, Indianapolis, IN 46219  
 Tel 1-877-671-7011 ■ Fax 800-851-0000  
 Zero.Customer.Support@allegion.com  
 www.zerointernational.com

Part No:

8878

Part description:

Head & jamb gasketing

Notes:

Provided by:

Customer name:

Job no:

Date:

Image may not be shown to scale

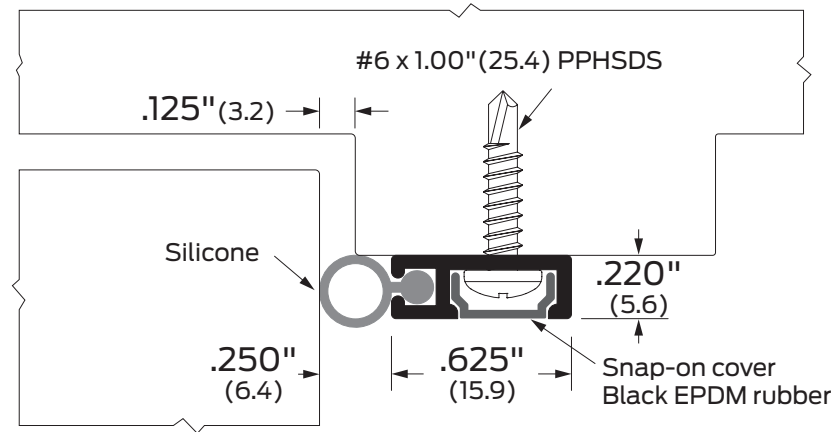

Certifications:

- Fire rated-UL10c
- Smoke and draft control

ANSI/BHMA:

8878AA, 8878BK, 8878D, 8878G

R3E164

Finishes:

- AA** Aluminum clear anodized
- BK** Aluminum black anodized
- D** Aluminum dark bronze anodized
- G** Aluminum gold anodized

Options:

- S** Order as a set
- SEC** Security screws

