



47255393

Model 870 Head and Jamb Protection



Model 870

Installation Instructions

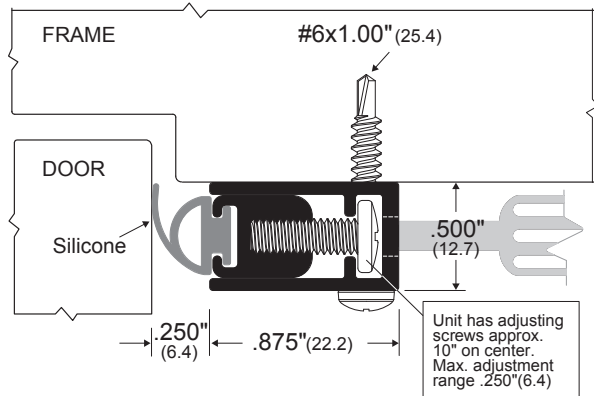

- 1 Close the door and measure the frame opening.
- 2 Install the gasketing (trim as necessary), head piece first. Place the piece against the face of door, making gentle contact between the rubber extrusion seal and the door. Fasten in place.
- 3 Place hinge side piece against the face of door, making gentle contact between the rubber extrusion seal and the door. Fasten in place. Repeat the same procedure with the lock side.
- 4 It is recommended that this gasketing product be set in a bead of caulking to ensure the integrity of the seal and prevent additional sound transmission.
- 5 Adjust the #870 with the adjustment screws as necessary for the desired seal and operation of the door.

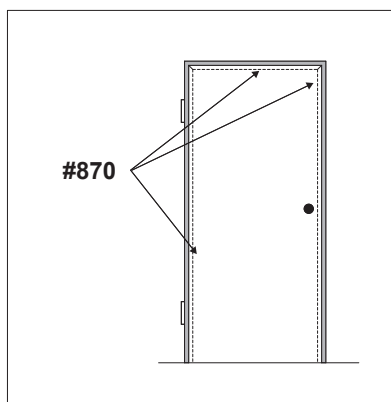

Customer Service

1-877-671-7011

www.allegion.com/us

© Allegion 2016
Printed in U.S.A.
47255393 Rev. 11/16-b